

N I G H T



1920<sup>®</sup>R  
MADE IN ITALY

**GRÜN**  
**BECK**

MARGARETENSTRASSE 93 | A-1050 WIEN  
TEL. +43 1 544 83 39 | GRUENBECK.CO.AT

# “PRODURRE PER TRAMANDARE”

*"Produce con onestà per tramandare alle generazioni future, costruendo mobili in grado di sfidare il tempo nel pieno rispetto dell'ambiente", questo è il pensiero che guida e motiva ogni azione quotidiana di Riva 1920.*

# “PRODUCE TO HAND DOWN TRADITIONS”

*"To produce with honesty in order to hand down our furniture to future generations, making furniture that defy time and fully respect our surroundings", this has been the idea that has guided and motivated every daily action of Riva 1920.*

# “PRODUZIEREN UM ZU ÜBERLIEFERN”

*"Ehrlich und aufrichtig produzieren, um den zukünftigen Generationen nachhaltige Möbelstücke zu überliefern, die den Zeichen der Zeit widerstehen können." Dieser Gedanke ist das Leitmotiv jeder alltäglichen Handlung von Riva 1920.*



INDICE · INDEX · INHALT



FILOSOFIA  
*PHILOSOPHY* 4  
*PHILOSOPHIE*

27

LETTI  
*BEDS*  
*BETTEN*



ARMADI  
*WARDROBES* 58  
*SCHRÄNKE*

87

COMÒ E COMODINI  
*CHESTS OF DRAWERS*  
*AND NIGHT-TABLES*  
*KOMMODEN UND*  
*NACHTTISCHE*

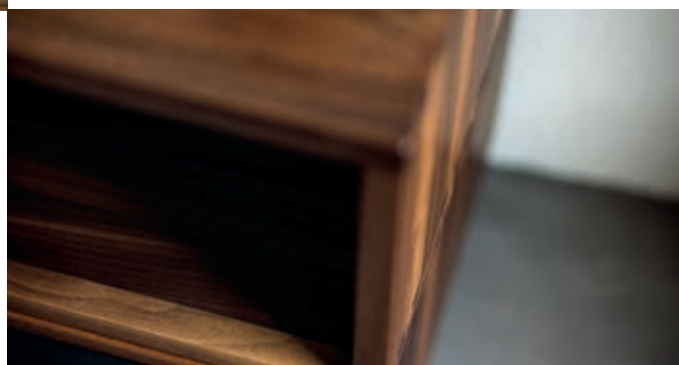

FINITURE  
*FINISHES* 111  
*AUSFÜHRUNGEN*

## RIVA 1920

Riva 1920 racconta di un dialogo ininterrotto tra estetica ed etica. La storia di un'azienda con solide radici e una grande artigianalità, che da oltre 100 anni coniuga innovazione e design nel rispetto dell'ambiente e della migliore tradizione del Made in Italy. Collaborando con i principali protagonisti di architettura e arte, si distingue per la produzione di arredi di eccellente qualità in cui il legno è il protagonista indiscusso, dando vita a qualcosa di speciale, unico e senza tempo.

*Riva 1920 tells of an uninterrupted dialogue between aesthetics and ethics. The story of a company with solid roots and great craftsmanship, for more than 100 years combines innovation and design with respect for the environment and the best tradition of Made in Italy. It cooperates with the main protagonists of architecture and art and stands out for the production of excellent quality furniture in which wood is the undisputed protagonist, giving life to something special, unique and timeless.*

*Riva 1920 Geschichte erzählt von einem ununterbrochenen Dialog zwischen Ästhetik und Ethik. Ein Unternehmen mit starken Wurzeln in der traditionellen Handwerkskunst, seit mehr als 100 Jahren Innovation und Design im vollen Respekt der Umwelt und der Tradition des „Made in Italy“ verbindet. Dank der Zusammenarbeit mit den wichtigsten Protagonisten der Architektur und der Kunst, zeichnet sich Riva 1920 durch die Produktion von hochwertigen, einzigartigen und zeitlosen Einrichtungsmöbeln, bei denen Holz der unbestrittene Protagonist ist.*



1920 R

SHOW ROOM

MUSEUM OF WOOD

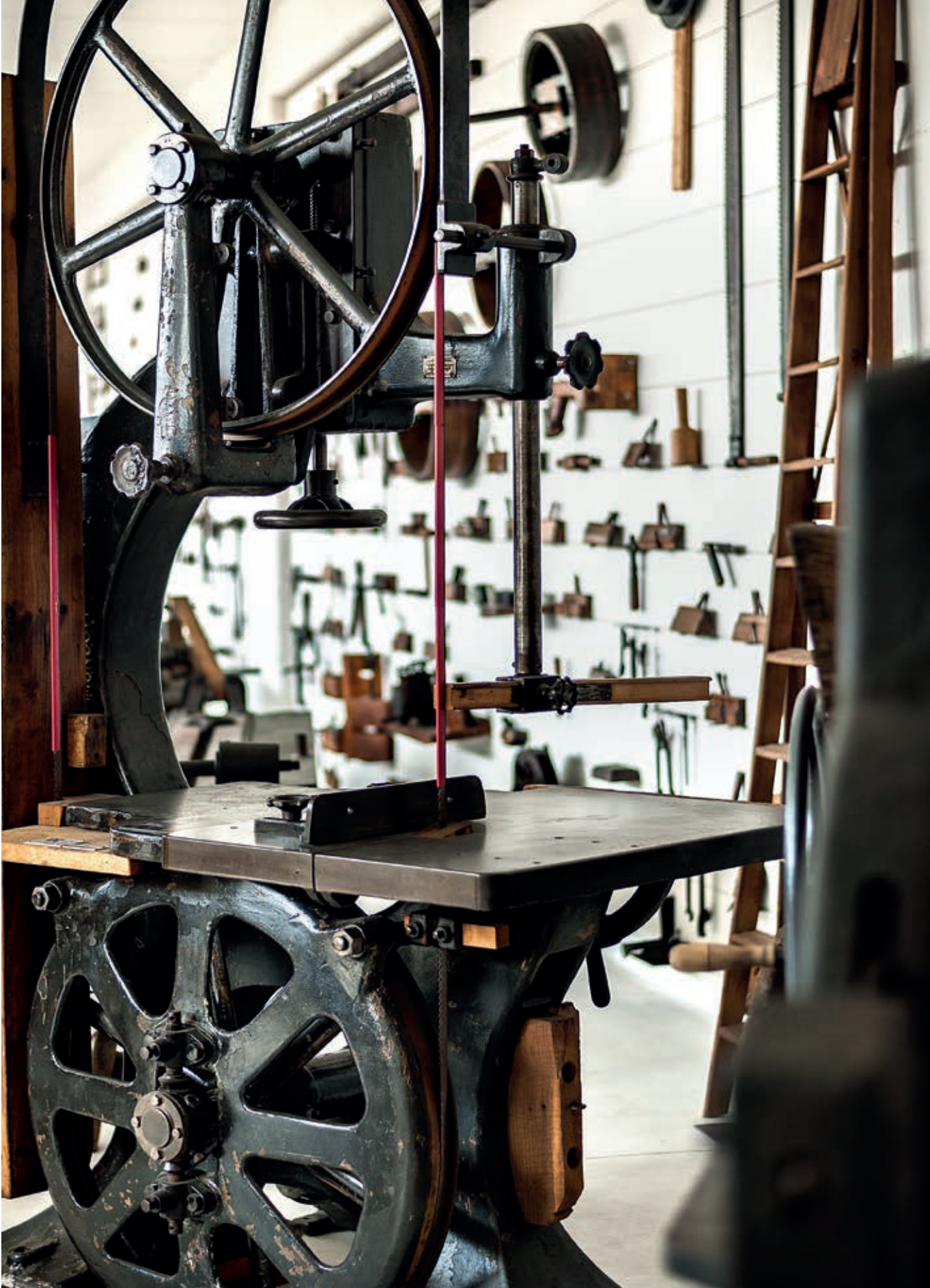

## PIU' DI 100 ANNI DI STORIA

Tutto nasce nel 1920 a Cantù, nel cuore della Brianza, in una piccola bottega artigiana a conduzione familiare specializzata nella produzione di arredi in legno massello dallo stile classico. Oggi alla guida dell'azienda vi è Maurizio Riva che, seguendo le orme del padre e del nonno, si impegna costantemente a favore della valorizzazione del legno naturale e della lavorazione manuale. "Produrre con onestà per tramandare alle generazioni future, costruendo mobili in grado di sfidare il tempo nel pieno rispetto dell'ambiente", da più di 100 anni questo è il pensiero che guida e motiva ogni azione quotidiana dell'azienda.

## MORE THAN 100 YEARS OF HISTORY

*Everything started in 1920 in Cantù, in the heart of Brianza, in a small family-run artisan workshop specializing in the production of classic style solid wood furniture.*

*Today the company is led by Maurizio Riva who, following in the footsteps of his father and grandfather, is constantly committed to promoting natural wood and manual processing.*

*"Produce with honesty to hand down traditions, making furniture that can challenge time in full respect of the environment", for more than 100 years this is the thought that guides and motivates every daily action of the company.*

## MEHR ALS 100 JAHRE GESCHICHTE

*Alles beginnt im Jahr 1920 in Cantù, im Herzen von Brianza, in einem kleinen familiengeführten Handwerksbetrieb, der auf die Herstellung von Massivholzmöbeln im klassischen Stil spezialisiert ist. Heute sind Herr Maurizio Riva an der Spitze des Unternehmens und er setzt die Arbeit des Vaters und des Großvaters fort, mit großer Achtung an die Aufwertung des Holzes und des Handwerks. "Ehrliche Handarbeit lässt die Tradition an zukünftige Generationen weiterleiten, im Respekt für Natur und Nachhaltigkeit", seit mehr als 100 Jahren ist dies der Gedanke, der jeden Tag die Firma leitet und motiviert.*

## I LEGNI

Salvaguardia dell'ambiente ed amore per la natura sono i principi fondamentali per Riva 1920. La qualità delle materie prime utilizzate è alla base del processo produttivo e parte dalla scelta dei legnami più pregiati. I prodotti della Collezione Riva 1920 sono realizzati in legno massello proveniente da tagli controllati e programmati utilizzando essenze come l'acero, il ciliegio, la rovere e la noce.

Un impegno concreto a favore della natura, anche grazie al progetto Natural Living.

## WOOD

*Environmental protection and love for nature are the main principles for Riva 1920. The quality of the raw materials used is the basis of the production process and starts with the choice of the finest woods. The products of the Riva 1920 collection are made of solid wood from controlled and programmed cuts using woods such as maple, cherry, oak and walnut. A concrete commitment to nature, also thanks to the Natural Living project.*

## HÖLZER

*Umweltschutz und Liebe zur Natur sind Grundprinzipien von Riva 1920. Die Qualität der verwendeten Rohstoffe ist die Grundlage des Produktionsprozesses, der von der Auswahl der wertvollsten Hölzer wie Ahorn, Kirschbaum, Eiche und Nussbaum beginnt. Das verwendete Massivholz kommt aus kontrollierten und programmierten Schnitten. Ein konkretes Engagement für die Natur, auch dank des Projektes Natural Living.*



## ARTIGIANALITA'

I prodotti Riva 1920 nascono da tecniche di lavorazione legate alla tradizione ebanista, grazie alle sapienti mani dei maestri falegnami altamente qualificati e dall'impiego di tecnologie all'avanguardia. La produzione artigiana supera le dinamiche di progettazione standard e garantisce un elevato livello di flessibilità e personalizzazione sia per la divisione home che per quella contract.

## CRAFTSMANSHIP

*Riva 1920 products are born from processing techniques linked to the cabinetmaker tradition, thanks to the skilled hands of highly qualified master carpenters and the use of cutting-edge technologies. The artisan production overcomes the dynamics of standard design and guarantees a high level of flexibility and customization both for the home division and for the contract one.*

## HANDWERKSKUNST

*Riva 1920 Produkte entstehen aus Verarbeitungstechniken, die auf die Tischlereitradition zurückgehen und sind die Frucht erfahrener Hände von ausgebildeten Tischlern und der Nutzung modernster Technologien. Die handwerkliche Produktion bietet hohe Flexibilität sowohl im „Home“ als auch im „Contract“ Bereich.*



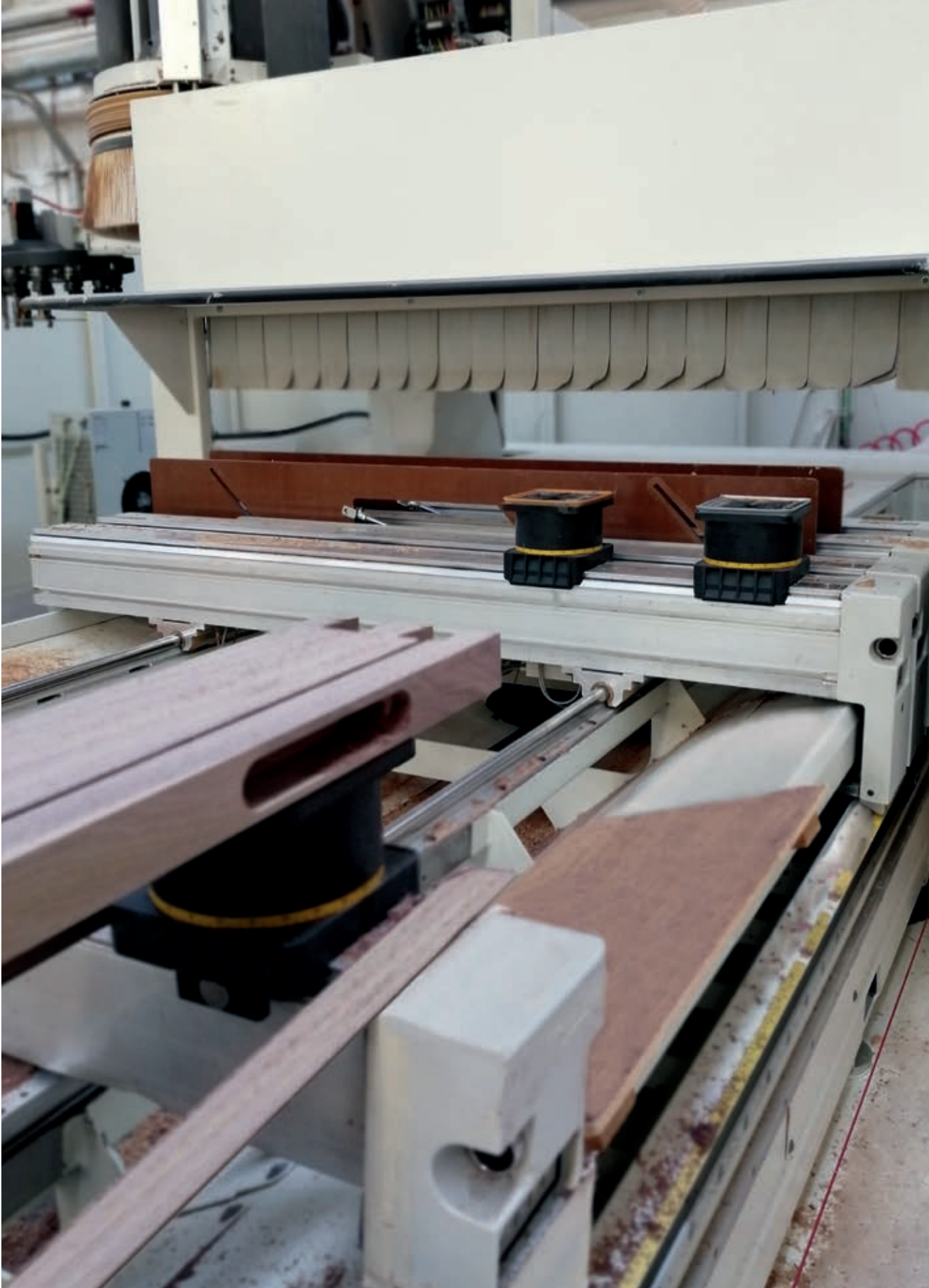

## TRADIZIONE ED INNOVAZIONE

Riva 1920 è una realtà produttiva fatta di tradizioni, cultura, creatività ed innovazione. Un'azienda dove l'artigianalità si combina con il progresso e la tecnologia, dove il design esalta le idee, l'attenzione e la cura dei dettagli danno vita a qualcosa di speciale, unico e senza tempo.

## TRADITION AND INNOVATION

*Riva 1920 is a company made of traditions, culture, creativity and innovation. A company where craftsmanship is combined with progress and technology, where design enhances ideas and the attention to details gives life to something special, unique and timeless.*

## TRADITION UND INNOVATION

*Riva 1920 ist eine Realität, die sich auf Traditionen, Kultur, Kreativität und Innovation gründet. Handwerkskunst vereint sich mit Fortschritt, Technologie und Design. Die Liebe zum Detail schenkt besondere, einzigartige und Zeitlose Produkte.*

## LAVORAZIONI

Il prodotto Riva 1920 è qualcosa di veramente unico nel suo genere: i legni vengono accuratamente selezionati e lavorati attraverso macchinari all'avanguardia uniti al lavoro di abili artigiani, che li rifiniscono a mano con olii o cere naturali. Taglio, bordatura, incollaggio, impiallacciatura, pressatura, levigatura, oliatura, montaggio e per finire controllo qualità. Ogni prodotto viene accuratamente assemblato e controllato prima di essere smontato ed imballato per la spedizione. Questi sono i passaggi fondamentali per arrivare al mobile finito. Solo vedendo la qualità e l'eccellenza di ogni fase del processo produttivo si può dare il giusto valore agli arredi Riva 1920.

## PROCESSING

*The Riva 1920 product is something truly unique: our woods are carefully selected and processed through cutting-edge machineries combined with the work of skilled craftsmen, who finish them by hand with natural oils or waxes. Cutting, edging, gluing, veneering, pressing, sanding, oiling, assembling and final quality control. Each product is carefully assembled and checked before being disassembled and packaged for shipping. These are the basic steps to get to the finished piece of furniture. Only by seeing the quality and excellence of each production phase you can give Riva 1920 furniture the right value.*

## VERARBEITUNG

*Das Produkt Riva 1920 ist etwas wirklich Einzigartiges: unsere Hölzer werden sorgfältig ausgewählt und mit modernsten Maschinen verarbeitet, kombiniert mit der Arbeit qualifizierter Handwerker, die sie von Hand mit natürlichen Ölen oder Wachsen bearbeiten. Schneiden, Kleben, Furnieren, Pressen, Schleifen, Ölen, Montage und schließlich Qualitätskontrolle. Jedes Produkt wird sorgfältig zusammengebaut und geprüft, bevor es zerlegt und für den Versand verpackt wird. Dies sind die grundlegenden Schritte bis zum fertigen Möbelstück.*

*Nur wenn man die Qualität jeder Phase des Produktionsprozesses sehen kann, kann man auf die Möbel von Riva 1920 den richtigen Wert legen.*





## DA DENTRO A FUORI

Presentare gli arredi mostrando la qualità racchiusa all'interno di essi è possibile attraverso la destrutturazione di alcuni pezzi, che sono stati volutamente spaccati e sezionati in modo da mostrare l'anima del mobile.

Il legno che si vede esternamente si trova anche all'interno, il cliente finale ha la certezza di aver acquistato un mobile 100% legno massello naturale.

I montanti laterali e gli schienali sono realizzati in multistrato e/o listellare massellati in legno di pioppo italiano. L'utilizzo di questa tecnica permette maggiore stabilità e resistenza.

I mobili sono composti da top e zoccolo in legno massello, al fine di garantire maggiore solidità e robustezza. I cassetti in legno massello sono realizzati con tradizionale tecnica a coda di rondine, queste giunzioni ad angolo retto sono particolarmente valide e contribuiscono al valore estetico e alla robustezza del manufatto.

## FROM THE INSIDE TO THE OUTSIDE

*Presenting the furniture and showing its inner quality is possible through the deconstruction of some pieces, which have been intentionally broken down and sectioned in order to show the "soul" of the piece of furniture.*

*The wood is also inside; the client has the guarantee of having bought a piece of furniture 100% made of solid natural wood.*

*The sides and the backs are in multilayer and/or blackboard of solid Italian poplar wood.*

*This technique allows more stability and resistance.*

*The pieces of furniture are characterized by top and plinth in solid wood, in order to guarantee more solidity and stability. The solid wood drawers are built with the traditional dovetail technique, these joints at right angle are particularly valid and contribute to the aesthetic value and to the durability of the product.*

## VON INNEN NACH AUSSEN

*Durch das Teilschnitt der Produkte ist es möglich, auch die innere Qualität zu zeigen. Die Produkte werden absichtlich geschnitten, um ihre "Seele" zu präsentieren.*

*Das äußere Holz ist auch innen, der Kunde hat so die Sicherheit, ein Möbel 100% aus natürlichem Massivholz zu kaufen.*

*Die Seitenwände und die Rückwände sind aus Multiplex und/oder Tischlerplatte aus massivem italienischem Pappelholz. Diese Technik ermöglicht mehr Stabilität und Festigkeit.*

*Die Möbel sind durch Abdeckplatte und Sockel aus Massivholz gekennzeichnet, die mehr Stabilität gewährleisten. Die Schubladen aus Massivholz sind mit der traditionellen Schwalbenschwanzverbindung gebaut, eine Technik die zum ästhetischen Wert und zur Langlebigkeit des Produkts beiträgt.*



TAVOLE IN LEGNO MASSELLO PIALLATE E INCOLLATE · PLANED AND GLUED SOLID WOOD SLABS ·  
MASSIVHOLZLEISTEN GESCHLIFFEN UND VERLEIMT



MULTISTRATO UTILIZZATO NELLA PRODUZIONE · MULTILAYER USED IN THE PRODUCTION ·  
IN PRODUKTION VERWENDETES MULTIPLEX



MULTISTRATO MASSELLATO E IMPIALLACCIATO · VENEERED BLOCKBOARD ·  
MULTIPLEX MASSIV GEKANTET UND FURNIERT



ZOCCOLO IN LEGNO MASSELLO · SOLID WOOD PLINTH ·  
SOCKEL AUS MASSIVHOLZ

## QUALITA' DEI MATERIALI

Il legno massello ed il multistrato sono i due materiali fondamentali nella produzione dei mobili a marchio Riva 1920. Il legno massello è l'ingrediente madre e vengono utilizzate essenze provenienti esclusivamente da tagli controllati e programmati. Questo significa che ogni volta che viene tagliato un albero per la produzione di mobili Riva 1920 ne vengono ripiantati degli altri, così il cerchio della vita non s'interrompe e alla natura viene restituito quel che ha donato. I pannelli multistrato (o listellare) sono invece realizzati utilizzando esclusivamente il legno di pioppo italiano proveniente dal Piemonte e dalla bassa Lombardia. Le piantagioni di pioppo crescono rapidamente (ciclo di circa 7/10 anni) ed il legname che si ricava è quindi una materia prima facilmente rinnovabile.

## QUALITY OF MATERIALS

*Solid wood and plywood are the two basic materials in the production of Riva 1920 brand furniture. Solid wood is the main ingredient and the only material used is wood coming exclusively from controlled and programmed cuts. This means that every time a tree is cut for the production of Riva 1920 furniture, others are planted so that the circle of life doesn't stop and nature is given back what it has given. The multilayer (or blockboard) panels are made only using Italian poplar wood from Piedmont and lower Lombardy. Poplar plantations grow rapidly (cycle of about 7/10 years) and the timber obtained is therefore an easily renewable raw material.*

## QUALITÄT DER MATERIALIEN

*Massives und furniertes Holz sind beide Grundmaterialien für die Herstellung von Riva 1920 Möbeln. Massivholz ist das Hauptelement und das verwendete Material ist zertifiziert und stammt aus programmierten Fällern. Dies bedeutet, dass jedes Mal, wenn ein Baum für die Herstellung von Riva 1920-Möbeln gefällt wird, neue Bäume gepflanzt werden, sodass der Kreislauf des Lebens nicht unterbrochen wird. Tischlerplatte und Multiplex werden aus italienischem Pappelholz aus den Regionen Piemont und Lombardei hergestellt. Pappelplantagen wachsen schnell (Zyklus von ca. 7/10 Jahren) und das gewonnene Holz ist daher ein leicht nachwachsender Rohstoff.*

## TRADIZIONE EBANISTA: L'INCASTRO A CODA DI RONDINE

Il prodotto Riva 1920 si contraddistingue per l'incastro a coda di rondine, tipico elemento della tradizione ebanista, caratterizzato da una serie di elementi maschi e femmine perfettamente complementari che vengono assemblati insieme a pressione. Queste giunzioni ad angolo retto sono particolarmente valide per la realizzazione non solo dei cassetti ma anche di altri elementi costruttivi degli arredi e contribuiscono al valore estetico ed alla robustezza del manufatto.

## CABINET-MAKING TRADITION: DOVETAIL JOINT

*The Riva 1920 product is characterized by the dovetail joint, a typical element of the cabinet-making tradition, characterized by tongue and groove elements, which are perfectly complementary and are fitted together by pressure. These joints are particularly suitable not only to make the drawers but also for other construction elements of the furnishings and contribute to the aesthetic value and strength of the product.*

## TISCHLEREITRADITION: SCHWALBENSCHWANZVERBINDUNG

*Das Produkt Riva 1920 zeichnet sich durch die Schwalbenschwanzverbindungen aus, eine typische Verarbeitung der Tischlereitradition. Eine Technik die sich durch Elemente „Nut und Feder“ gekennzeichnet ist. Diese Verbindungen sind besonders geeignet nicht nur für Schubladen, sondern auch für die Möbelkonstruktion und geben dem Produkt einen ästhetischen Wert.*





## BASSO IMPATTO AMBIENTALE

Nel petto dell'azienda batte un cuore fatto di legno. Riva 1920 ama la natura, ma anche i suoi clienti ed è per questo che offre un prodotto autentico fatto in legno nel pieno rispetto dell'ambiente e delle persone che lo abitano. Ogni elemento è sottoposto a dettagliate verifiche di conformità qualitativa e funzionale alle quali si aggiunge l'impiego di collanti vinilici e finiture ad olio e cera vegetale, garanzia di un prodotto autentico e completamente naturale.

## ENVIRONMENTALLY FRIENDLY

*A heart made of wood beats in the chest of the company. Riva 1920 loves nature, but also its customers and that is why it offers an authentic product made of real natural wood, in full respect of the environment and the people who live there.*

*Each element is subjected to detailed quality and functional conformity checks, to which is added the use of vinyl glues and finish based on vegetable wax and oil, a guarantee of an authentic and completely natural product.*

## GERINGE UMWELTAUSWIRKUNGEN

*Ein Herz aus Holz schlägt in der Brust des Unternehmens. Fa. Riva 1920 liebt die Natur und achtet auf Kunden, deswegen bietet sie ein authentisches Produkt aus Holz an, dass in vollem Respekt der Umwelt und den Menschen gegenüber gefertigt wird. Es wird sorgfältig geprüft, dass jedes Element den hohen Qualitätsstandards entspricht. Die Verwendung von Vinylklebern und Öl- oder Wachsbehandlungen sind Garantie eines natürlichen Produktes.*

## COLLEZIONE ZONA NOTTE

Soluzioni d'arredo moderne su misura e dalle linee essenziali e curate, fatte di essenze nobili e con rifiniture naturali realizzate a mano, in grado di soddisfare le esigenze anche della clientela più sofisticata. Il design ecosostenibile si fonde con la funzionalità e l'innovazione tecnologica, mantenendo i valori della tradizione artigiana. L'interno degli armadi è realizzato in legno profumato di Cedro del Libano, antibatterico ed antitarpe naturale. E' offerta una vasta gamma di accessori per l'attrezzatura interna a partire dalle cassettiere con incastri a coda di rondine. Non ci sono limiti alla voglia di creare un ambiente dal mood unico ed esclusivo per riscoprire il piacere di vivere la propria camera da letto all'insegna dell'eleganza e del comfort.

## NIGHT AREA COLLECTION

*Modern custom-made furniture solutions with essential and refined lines, made of noble essences and natural finishes worked by hand, able to meet the needs of even the most sophisticated customers. Eco-friendly design blends with functionality and technological innovation, maintaining the values of the artisan tradition. The interior of the wardrobes is made of perfumed Lebanon Cedar wood, a natural anti-bacterial and anti-moth essence. A wide range of accessories completes the inside equipment of the closet starting from drawers with dovetail joints. There are no limits to the wish to create an ambiance with a unique and exclusive mood to rediscover the pleasure of living your bedroom in the name of elegance and comfort.*

## SCHLAFBEREICH KOLLEKTION

*Moderne maßgeschneiderte Möbellösungen mit essentiellen und raffinierten Linien, aus edlen Essenzen und natürlichen Ausführungen, die von Hand bearbeitet werden und in der Lage sind, die Bedürfnisse selbst der anspruchsvollsten Kunden zu erfüllen.*

*Umweltfreundliches Design verbindet sich mit Funktionalität und technologischer Innovation und bewahrt die Werte der handwerklichen Tradition. Das Innere der Schränke besteht aus parfümiertem Zedernholz aus Libanon mit natürlichen antibakteriellen und Mottenschutzigenschaften. Eine breite Palette von Zubehör vervollständigt die Innenausstattung des Schrankes ab Schubladen mit Schwalbenschwanzfugen. Dem Wunsch, ein Lebensraum mit einer einzigartigen und exklusiven Stimmung zu schaffen, um das Vergnügen, Ihr Schlafzimmer im Namen von Eleganz und Komfort zu leben, wiederzuentdecken, sind keine Grenzen gesetzt.*





# LETTI · BEDS · BETTEN



**BAM BAM** 28-31



**MY BED** 32-37



**NATURA 6** 38-41



**REVO BED - REVO SOFT BED** 42-47



**RIALTO BED** 48-51



**SLEEPY** 52-57

# BAM BAM

TERRY DWAN



BAM BAM DOUBLE - BAM BAM FRENCH  
CM: L. 150/170/180/190/210 · P. 217,4 · H. 85

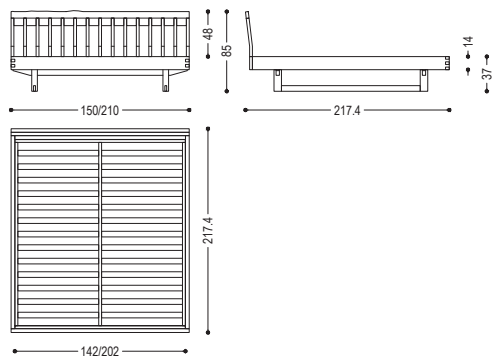

BAM BAM SINGLE  
CM: L. 110 · P. 217,4 · H. 85

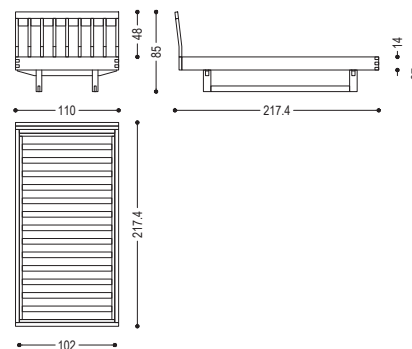

Letto interamente realizzato in legno massello, caratterizzato da un incastro a pettine realizzato a mano in abbinata a testata a liste racchiuse da una fascia con bordo naturale. Linee squadrate per struttura e basamento.

Qui: rovere senza nodi, finitura cera. A destra e nelle pagine seguenti noce con nodi, finitura olio.

*Bed completely made of solid wood with dovetail joints made completely by hand, combined with a headboard made of slats enclosed by a plank with natural side. Square lines for the structure and the base.*

*On this page: oak without knots, wax finish. On the right and the following pages: walnut with knots, oil finish.*

*Bett völlig aus Massivholz. Das Kopfteil besteht aus Holzleisten, die durch ein Holzbrett mit Naturkante zusammengehalten werden. Schlichtes Gestell. Auf dieser Seite: Eiche ohne Knoten gewachst. Rechts und auf den nächsten Seiten: Nussbaum mit Knoten geölt.*









# MY BED

STUDIO ZERO

Letto con struttura realizzata in legno massello abbinata ad una testata imbottita dalle linee morbide ed arrotondate, rivestita in pelle o tessuto sfoderabile. Giroletto stondato.

Qui, a sinistra e nelle successive: struttura rovere con nodi, finitura cera e testata imbottita pelle Camoscio 26.

*Bed with structure in solid wood and padded headboard with soft and rounded shapes, covered with fabric or leather. Removable covers for the fabric version. Rounded bed sides.*

*In the pictures: structure in oak with knots, wax finish, and headboard covered in leather Camoscio 26.*

*Bett mit Gestell aus Massivholz und gepolsterem Kopfteil mit Leder oder Stoff bezogen. Die Stoffversion ist abnehmbar. Abgerundeter Bettrahmen.*

*In den Fotos: Struktur aus Eiche mit Knoten gewachst und Kopfteil mit Leder Camoscio 26 bezogen.*



MY BED DOUBLE - MY BED FRENCH  
CM: L. 152/172/182/192/212 · P. 220 · H. 95

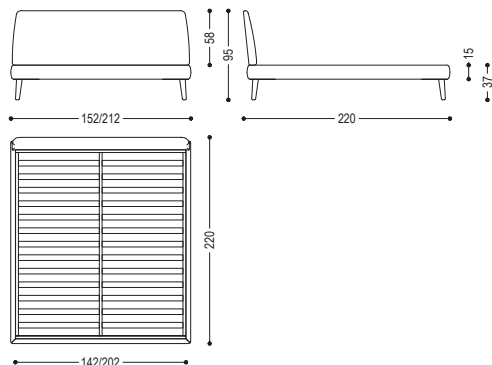

MY BED SINGLE  
CM: L. 112 · P. 220 · H. 95

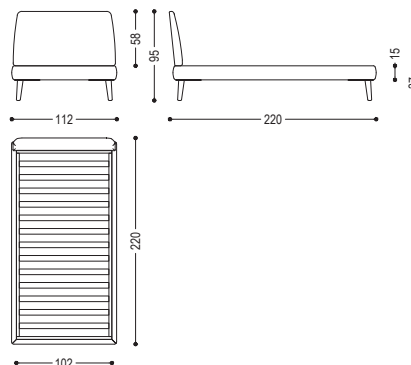









# NATURA 6

C.R.&S. RIVA1920



## NATURA 6 DOUBLE - NATURA 6 FRENCH

CM: L. 150/170/180/190/210 · P. 218 · H. 90

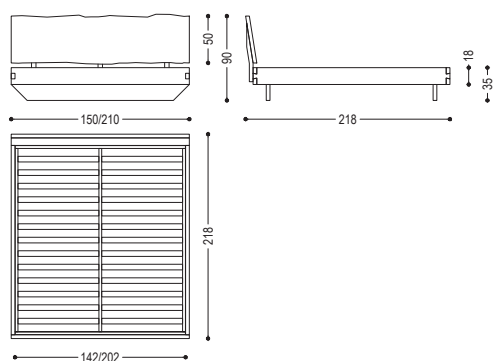

## NATURA 6 SINGLE

CM: L. 110 · P. 218 · H. 90

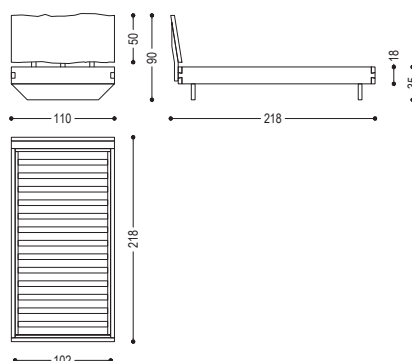

Letto interamente realizzato in legno massello, caratterizzato da testata costituita da tavola unica con bordo superiore naturale e giroletto con incastro a pettine realizzato interamente a mano.

Qui, a destra e nelle successive: noce con nodi, finitura olio.

*Bed completely made of solid wood with headboard composed of a single plank with upper natural side. Bed sides with dovetail joints made completely by hand.*

*In the pictures: walnut with knots, oil finish.*

*Bett völlig aus Massivholz mit Kopfteil bestehend aus einer Holzplatte mit Naturkante und Rahmen mit Schwalbenschwanzverbindung von Hand gefertigt.*

*In den Fotos: Nussbaum mit Knoten geölt.*









## REVO BED - REVO SOFT BED

GIULIANO & GABRIELE CAPPELLETTI

Letto interamente realizzato in legno massello, caratterizzato da incastri a coda di rondine che uniscono i piedini alla struttura. Disponibile anche nella variante della testata con cuscini rivestiti in pelle o tessuto, che ne aumentano il comfort (Revo Soft Bed).

Qui, a sinistra e nelle successive: struttura noce con nodi, finitura olio e testata imbottita pelle Nabuk 18.

*Bed entirely made of solid wood, characterized by dovetail joints that connect the feet to the structure. Available with cushions covered in leather or fabric increase its comfort (Revo Soft Bed).*

*In the pictures: structure in walnut with knots, oil finish, and headboard covered in leather Nabuk 18.*

*Bett völlig aus Massivholz, mit Schwalbenschwanzverbindungen zwischen Füßchen und Bettrahmen. Die Kissen, mit Leder oder Stoff bezogen, erhöhen den Komfort (Revo Soft Bed).*

*In den Fotos: Struktur aus Eiche mit Nussbaum Mit Knoten und Kopfteil mit Leder Nabuk 18 bezogen.*



REVO BED SOFT DOUBLE - REVO BED SOFT FRENCH

CM: L. 148/208 · P. 234,1 · H. 97

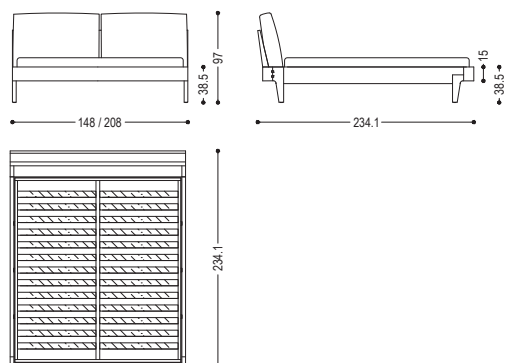

REVO BED SINGLE

CM: L. 108 · P. 234,1 · H. 97

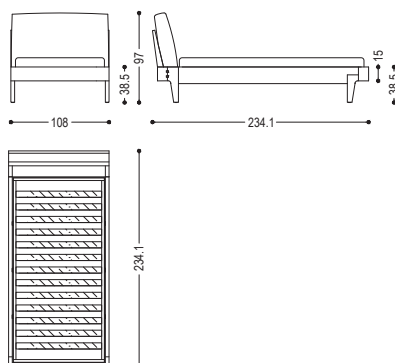

Per maggiori informazioni consultare il Pricelist

For any further information please refer to the Pricelist

Weitere Informationen entnehmen Sie bitte der Preisliste









# RIALTO BED

GIULIANO CAPPELLETTI



RIALTO BED DOUBLE - RIALTO BED FRENCH  
CM: L. 254/274/284/294/314 · P. 213 · H. 90.5

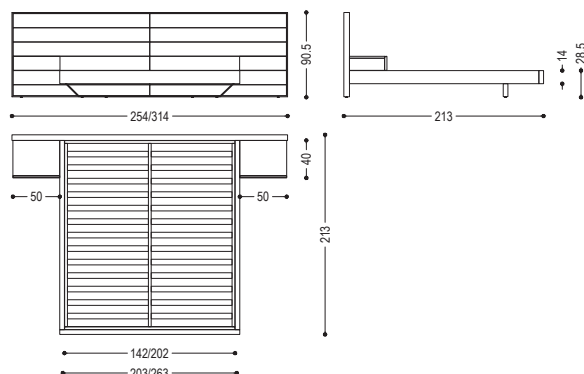

Letto in legno listellare impiallacciato costituito da testata incorniciata da una struttura in ferro e giroletto in massello, con comodini integrati. Qui, a destra e nelle successive: testata, giroletto e comodini rovere con nodi, finitura cera, cornice ferro laccato Irondust.

*Bed made of veneered blockboard with headboard framed by an iron structure and bed sides in solid wood, with integrated bedside tables. In the pictures: headboard, bed sides and night tables in oak with knots, wax finish, headboard frame lacquered iron dust.*

*Bett aus furnierter Tischlerplatte. Kopfteilrahmen aus Eisen und Bettrahmen aus Massivholz, mit integrierten Nachttischen. In den Fotos: Kopfteil, Bettrahmen und Nachttische in Eiche mit Knoten gewachst, Kopfteilrahmen lackiert iron dust.*







# SLEEPY

VEGNI DESIGN

Letto con struttura realizzata in legno massello abbinata ad una testata imbottita curvilinea rivestita in pelle o tessuto. Giroletto stondato. Qui e a destra: struttura in noce con nodi, finitura olio e testata imbottita pelle Camoscio 10. Da pagina 54 a pag 57 struttura in noce con nodi, finitura olio e testata in pelle Nabuk 36.

*Bed with structure made of solid wood and curved padded headboard covered with leather or fabric. Rounded bed sides.*

*On this page and on the right: structure in walnut with knots, oil finish, and headboard covered in leather Camoscio 10. From page 54 to page 57: structure in walnut with knots, oil finish, and headboard covered in leather Nabuk 36.*

*Bett mit Gestell aus Massivholz kombiniert mit gepolstertem Kopfteil mit Leder- oder Stoffbezug. Abgerundeter Bettrahmen.*

*Auf dieser Seite und rechts: Struktur aus Nussbaum mit Knoten geölt und Kopfteil mit Leder Camoscio 10 bezogen. Seite 54 bis Seite 57: Struktur aus Nussbaum mit Knoten geölt und Kopfteil mit Leder Nabuk 36 bezogen.*



SLEEPY DOUBLE - SLEEPY FRENCH

CM: L. 157/177/187/197/217 · P. 235,8 · H. 104,5

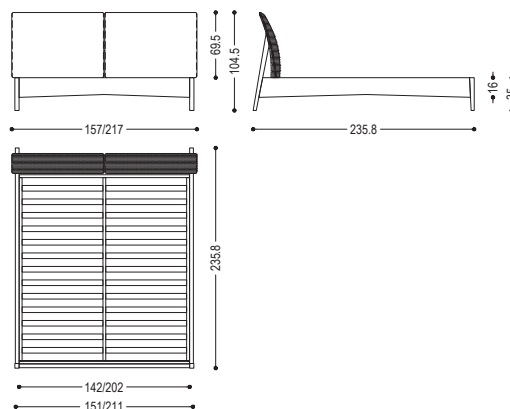

SLEEPY SINGLE

CM: L. 117 · P. 235,8 · H. 104,5

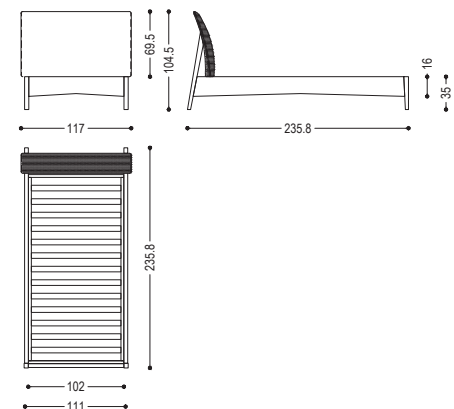











# ARMADI · WARDROBES · SCHRÄNKE



**AVANT** 62-69



**AVANT OPEN** 70-73



**FOUR SEASONS GLASS** 74-77



**HANGAR LIGHT** 78-81



**NUIT** 82-85





## GLI ARMADI

L'armadio Riva 1920 è un prodotto unico e versatile, frutto di un'accurata ricerca e progettazione, realizzato in legno massello da tagli controllati e programmati e listellare impiallacciato. Si contraddistingue per la perfetta combinazione di eleganti elementi della tradizione artigianale ebanista, come gli incastri a coda di rondine, per l'ecosostenibilità nell'impiego di finiture a base di oli e cere naturali ed anche per un moderno e funzionale sistema di illuminazione a LED.

Le possibilità di personalizzazione sono molteplici, si possono realizzare armadi e cabine su misura adatti a soddisfare le richieste della clientela più esigente, offrendo ampia scelta di attrezzatura interna ed accessori.

Il mobile è impreziosito dagli interni realizzati in legno di cedro del Libano, antitarma ed antibatterico naturale, che rilascia una gradevole profumazione.

Vasta anche la gamma di finiture per la struttura esterna e le ante: queste ultime sono disponibili non solo in legno ma anche nella versione vetro con telaio in alluminio, che conferisce leggerezza ed eleganza alla struttura.

Un raffinato armadio sartoriale non solo per contenere ma che parla di voi!

## WARDROBES

*The Riva 1920 wardrobe is a unique and flexible product, the result of a careful research and design, made of solid wood from controlled and programmed cuts and veneered blockboard. It is characterized by the perfect combination of elegant elements coming from the artisan woodwork tradition, such as the dovetail joints, by the eco-sustainability using finishes based on natural oils and waxes and also by a modern and functional LED lighting system.*

*The customization possibilities are multiple, tailor-made wardrobes and walk-in closets can be produced to meet the needs of the most demanding customers, offering a wide choice of internal equipment and accessories.*

*The closet is enhanced with interiors made of Lebanon cedar wood, natural moth-proof and antibacterial, which gives off a pleasant fragrance.*

*The range of finishes for the external structure and the doors is wide, too. The latter are available not only in the wood but also in the glass version with aluminum frame, which gives lightness and elegance to the structure.*

*A refined bespoke wardrobe not only to contain but that talks about you!*

## SCHLAFBEREICH KOLLEKTION

*Ein Schrank von Riva 1920 ist ein einzigartiges und flexibles Produkt, das Ergebnis sorgfältiger Forschung und Design aus massivem Holz aus kontrollierten und programmierten Schnitten und furnierter Tischlerplatte hergestellt. Er zeichnet sich durch die perfekte Kombination eleganter Elemente der Handwerkstradition wie Schwalbenschwanzverbindungen, durch die ökologische Nachhaltigkeit bei der Verwendung von Ausführungen auf Basis natürlicher Öle und Wachse sowie durch ein modernes und funktionales LED-Beleuchtungssystem aus.*

*Die Möglichkeiten sind vielfältig, maßgeschneiderte Kleiderschränke und Ankleiden können erstellt werden, um den Anforderungen der anspruchsvollsten Kunden entgegen zu kommen, und bieten eine große Auswahl an inneren Bestandteilen.*

*Die Schränke sind innen aus duftendem Zedernholz, das gegen Motten wirkt, natürlich antibakteriell ist und einen angenehmen Duft abgibt.*

*Es gibt auch eine breite Auswahl an Ausführungen für die Außenstruktur und die Türen: letztere sind nicht nur in Holz erhältlich, sondern auch in der Glasversion mit Aluminiumrahmen, was der Struktur Leichtigkeit und Eleganz verleiht.*

*Ein raffinerter Kleiderschrank, der nicht nur ein Behälter ist, sondern auch von Ihnen spricht!*



# AVANT

C.R.&S. RIVA1920

Armadio listellare e legno massello, con ante a battente in vetro con telaio in alluminio laccato. Propone un'organizzazione funzionale e componibile dei vari elementi sulla base delle esigenze contenitive e delle dimensioni richieste. Personalizzabile con l'inserimento di appendiabiti, ripiani, cassettiere in legno massello con tradizionale incastro a coda di rondine. Ideale con interni in legno di cedro profumato, naturale rimedio contro le tarme. Illuminazione a LED disponibile su richiesta.

Qui, a sinistra e nelle pagine da 64 a 67: esterno e interno cedro, ante in vetro trasparente. Nelle pagine 68 e 69, bespoke project: esterno e interno noce con nodi.

*Walk-in closet made of blockboard and solid wood, it offers a functional and modular organization of the different elements, based on the customer's needs and requested sizes. It can be customized with the addition of cloth-hangers, shelves, chests of drawers in solid wood with traditional dovetail joints and other accessories. Perfect with internal fitting in scented cedar, a natural anti-moth agent. LED lighting available upon request. On this page, on the left and from page 64 to page 67: outside and inside in cedar, doors in clear glass. from page 68 to page 69, bespoke project: inside and outside in walnut with knots.*

*Schrank aus Tischlerplatte und Massivholz. Glastüren mit Rahmen aus Aluminium lackiert. Funktionelle Innenausstattung, je nach Wunsch erhältlich, mit Kleiderstangen, Einlegeböden, Schubladen mit traditioneller Schwalbenschwanzverbindung usw. Perfekt mit Innenausstattung aus duftendem Zedernholz, ideal gegen Kleidermotten. Auf Wunsch mit Led-Beleuchtung verfügbar.*

*Auf dieser Seite, links und Seite 64 bis Seite 67: innen und außen aus Zeder; Türen aus transparentem Glas. Seite 68 bis Seite 69, Sonderanfertigung: innen und außen aus Nussbaum mit Knoten.*

CM: L. 106/412 · P. 61 · H. 220/240/260

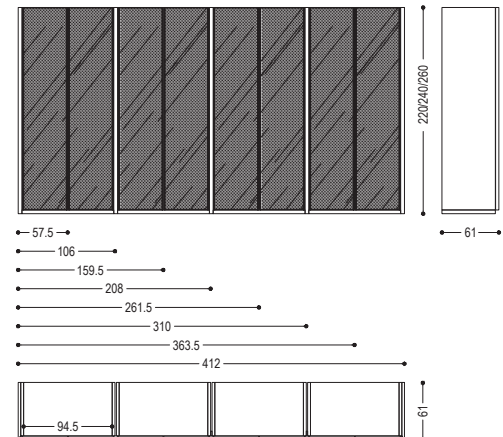

Per maggiori informazioni consultare il Pricelist  
For any further information please refer to the Pricelist  
Weitere Informationen entnehmen Sie bitte der Preisliste















## AVANT OPEN

C.R.&S. RIVA1920

Cabina armadio in listellare e legno massello, propone un'organizzazione funzionale e componibile dei vari elementi sulla base delle esigenze contenitive e delle dimensioni richieste. Personalizzabile con l'inserimento di appendiabiti, ripiani, cassettiere in legno massello con tradizionale incastro a coda di rondine e accessori vari. Ideale con interni in legno di cedro profumato, naturale rimedio contro le tarme. Illuminazione a LED disponibile su richiesta.

Qui, a destra e nelle pagine a seguire: cedro, finitura cera.

*Walk-in closet made of blockboard and solid wood, it offers a functional and modular organization of the different elements, based on the customer's needs and requested sizes. It can be customized with the addition of cloth-hangers, shelves, chests of drawers in solid wood with traditional dovetail joints and other accessories. Perfect with internal fitting in scented cedar, a natural anti-moth agent. LED lighting available upon request. In the pictures: cedar, wax finish.*

*Ankleide aus Tischlerplatte und Massivholz. Funktionelle Innenausstattung, je nach Wunsch erhältlich, mit Kleiderstangen, Einlegeböden, Schubladen mit traditioneller Schwalbenschwanzverbindung usw. Perfekt mit Innenausstattung aus duftendem Zedernholz, ideal gegen Kleidermotten. Auf Wunsch mit Led-Beleuchtung verfügbar.*

*In den Fotos: Zeder gewachst.*



CM: L. 57,5/208 · P. 30/50 · H. 220/240/260

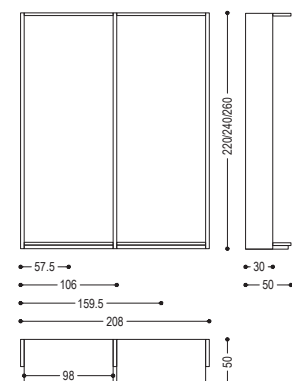

Per maggiori informazioni consultare il Pricelist  
For any further information please refer to the Pricelist  
Weitere Informationen entnehmen Sie bitte der Preisliste



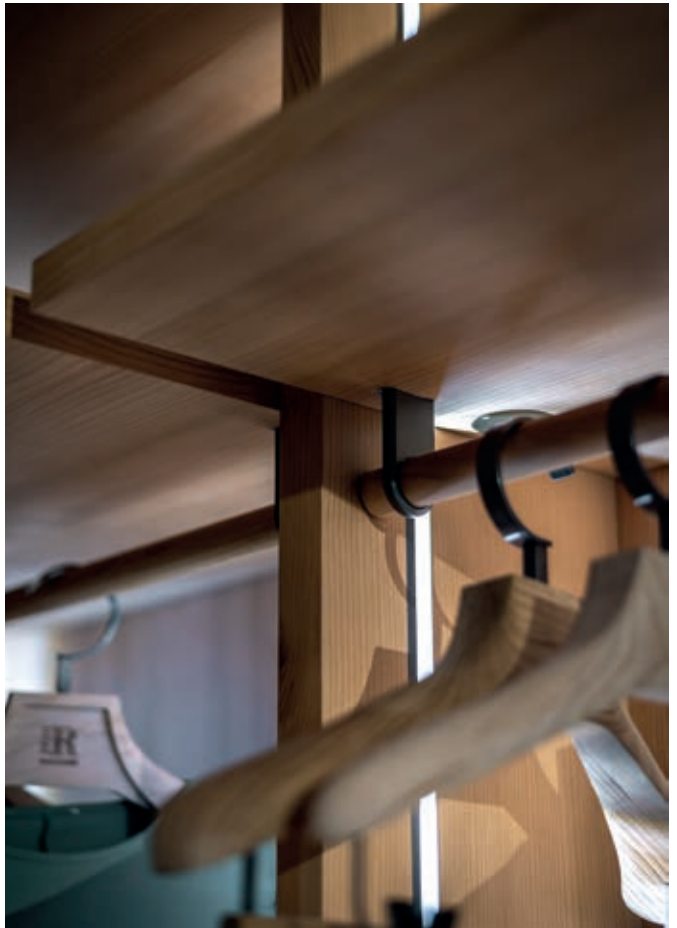



## FOUR SEASONS GLASS

C.R.&S. RIVA1920

Armadio in listellare e legno massello con ante a battente in vetro con cornice in legno e maniglie fresate. Propone un'organizzazione funzionale e componibile dei vari elementi sulla base delle esigenze contenitive e delle dimensioni richieste. Personalizzabile con l'inserimento di appendiabiti, ripiani, cassettiere in legno massello con tradizionale incastro a coda di rondine e accessori vari. Ideale con interni in legno di cedro profumato, naturale rimedio contro le tarme. Illuminazione a LED disponibile su richiesta.

Qui, a destra e nelle pagine a seguire: esterno noce con nodi, finitura olio, interno cedro e ante vetro trasparente.

*Wardrobe in veneered blockboard and solid wood, glass doors with wooden frame and grooved handles. It offers a functional and modular organization of the different elements, based on the customer's needs and requested sizes. It can be customized with the addition of cloth-hangers, shelves, chests of drawers in solid wood with traditional dovetail joints and other accessories. Perfect with internal fitting in scented cedar, a natural anti-moth agent. LED lighting available upon request. In the pictures: outside in walnut with knots, oil finish, inside in cedar and doors in clear glass.*

Schrank aus Tischlerplatte und Massivholz, mit Drehtüren aus Glas mit Holzrahmen und Griffmulden. Funktionelle Innenausstattung, je nach Wunsch erhältlich, mit Kleiderstangen, Einlegeböden, Schubladen mit traditioneller Schwalbenschwanzverbindung usw. Perfekt mit Innenausstattung aus duftendem Zedernholz, ideal gegen Kleidermotten. Auf Wunsch mit Led-Beleuchtung verfügbar. In den Fotos: außen aus Nussbaum mit Knoten geölt, innen aus Zeder und Türen aus transparentem Glas.

CM: L. 100,8/399,6 · P. 60 · H. 223/240

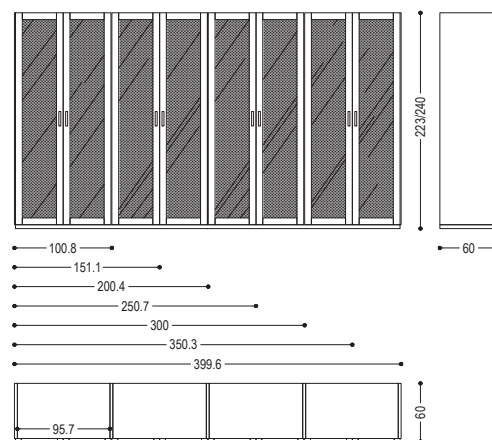

Per maggiori informazioni consultare il Pricelist  
For any further information please refer to the Pricelist  
Weitere Informationen entnehmen Sie bitte der Preisliste











# HANGAR LIGHT

C.R.&S. RIVA1920



Armadio in listellare e legno massello con ante scorrevoli su doppi binari in alluminio, caratterizzate da frontali completamente lisci dotati di maniglie in legno a tutta altezza, ottenute da listelli di legno posti all'estremità delle ante scorrevoli. Propone un'organizzazione funzionale e componibile dei vari elementi sulla base delle esigenze contenitive e delle dimensioni richieste. Personalizzabile con l'inserimento di appendiabiti, ripiani, cassettiere in legno massello con tradizionale incastro a coda di rondine e accessori vari. Ideale con interni in legno di cedro profumato, naturale rimedio contro le tarme. Illuminazione a LED disponibile su richiesta. Qui: noce con nodi, finitura olio. A sinistra: rovere con nodi, finitura cera. Nelle pagine a seguire (bespoke project), rovere senza nodi, finitura cera.

*Wardrobe in veneered blockboard and solid wood, with sliding doors on double aluminium gliders. Doors with smooth front with a wooden slat serving as handle positioned on the edge, full height. It offers a functional and modular organization of the different elements, based on the customer's needs and requested sizes. It can be customized with the addition of cloth-hangers, shelves, chests of drawers in solid wood with traditional dovetail joints and other accessories. Perfect with internal fitting in scented cedar, a natural anti-moth agent. LED lighting available upon request. On this page: walnut with knots, oil finish. On the left: oak with knots, wax finish. On the following pages (bespoke project): oak without knots, wax finish.*

*Schrank aus Tischlerplatte und Massivholz, mit Schiebetüren auf Vollauszüge aus Aluminium. Glatte Fronten mit Holzgriffen auf der ganzen Höhe entlang. Funktionelle Innenausstattung, je nach Wunsch erhältlich, mit Kleiderstangen, Einlegeböden, Schubladen mit traditioneller Schwalbenschwanzverbindung usw. Perfekt mit Innenausstattung aus duftendem Zedernholz, ideal gegen Kleidermotten. Auf Wunsch mit Led-Beleuchtung verfügbar.*

*Auf dieser Seite: Nussbaum mit Knoten geölt. Links: Eiche mit Knoten gewachst. Auf den nächsten Seiten (Sonderanfertigung): Eiche ohne Knoten gewachst.*

CM: L. 200/400 · P. 67,5 · H. 223/240/260

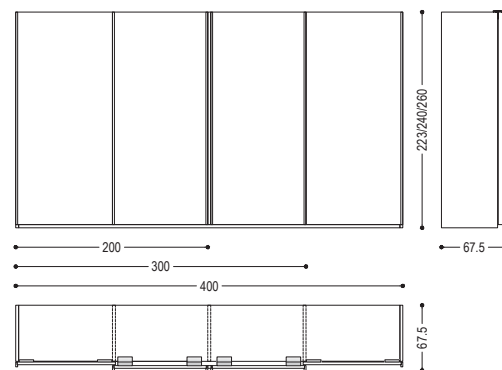

Per maggiori informazioni consultare il Pricelist  
For any further information please refer to the Pricelist  
Weitere Informationen entnehmen Sie bitte der Preisliste





# NUIT

GIULIANO CAPPELLETTI



CM: L. 133/264 · P. 63/67 · H. 190

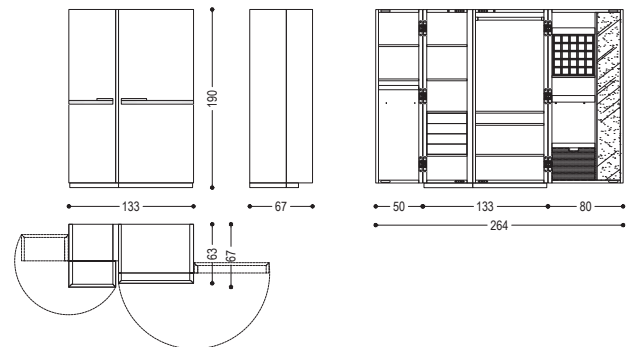

Armadio in listellare e legno massello con ante a battente asimmetriche caratterizzate da frontali completamente lisci dotati di maniglia in metallo. Reinterpretazione del tradizionale baule-contenitore rivisitato in chiave contemporanea, propone un'organizzazione funzionale dei vari elementi. Ideale con interni in legno di cedro profumato, naturale rimedio contro le tarme. Illuminazione a LED in dotazione. Qui, a destra e nelle pagine a seguire: esterno noce senza nodi, finitura olio, interno cedro.

*Wardrobe in blockboard and solid wood, with asymmetrical doors with completely smooth fronts and metal handle. Modern reinterpretation of the traditional chest-container; it offers a practical organization of the various elements. Perfect with internal fitting in scented cedar, a natural anti-moth agent. LED lighting included.*

*In the pictures: outside in walnut without knots, oil finish, inside in cedar.*

*Schrank aus Tischlerplatte und Massivholz mit asymmetrischen glatten Türen mit Metallgriff. Traditionelle Schrankkoffer auf moderne Weise interpretiert, mit funktioneller Innenausstattung aus duftendem Zedernholz, ideal gegen Kleidermotten. Mit LED-Beleuchtung ausgestattet. In den Fotos: außen aus Nussbaum ohne Knoten geölt, innen aus Zeder.*





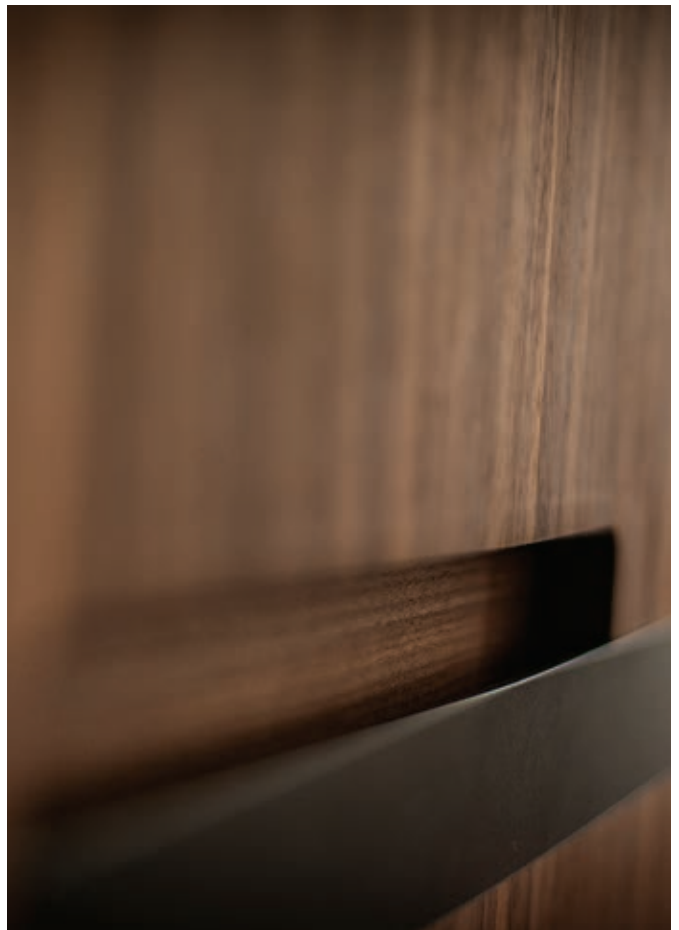



COMÒ E COMODINI · CHESTS OF DRAWERS AND  
NIGHT-TABLES · KOMMODEN UND NACHTTISCHE



**KYOTO 6** 88-89



**REVO NIGHT DRESSER** 90-93



**RIALTO NIGHT FLY DRESSER** 94-97



**FREEDOM** 98-99



**KYOTO 5** 100-101



**NIGHT-NIGHT** 102-103



**REVO NIGHT TABLE** 104-105



**RIALTO NIGHT** 106-107



**RIALTO NIGHT FLY** 108-109

# KYOTO 6

C.R.&S. RIVA1920



Cassettiera in listellare e legno massello, con 4 cassetti realizzati con tradizionale incastro a coda di rondine.

Qui e nella pagina destra: rovere senza nodi, finitura cera.

*Chest of drawers in blockboard and solid wood, with 4 drawers assembled with traditional dovetail joints.*

*In the pictures: oak without knots, wax finish.*

*Kommode aus Tischlerplatte und Massivholz, mit 4 Schubladen mit traditioneller Schwalbenschanzverbindung gefertigt.*

*In den Fotos: Eiche ohne Knoten gewachst.*

CM: L. 120 · P. 50 · H. 80

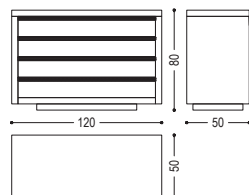





# REVO NIGHT DRESSER

GIULIANO & GABRIELE CAPPELLETTI



REVO NIGHT DRESSER 1  
CM: L. 120 · P. 50 · H. 70

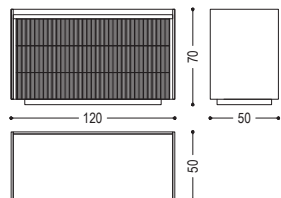

REVO NIGHT DRESSER 2  
CM: L. 180 · P. 50 · H. 70

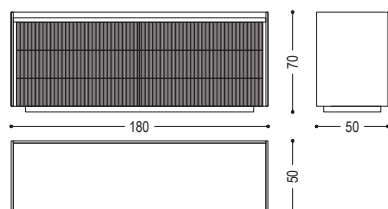

Cassettiera in listellare e legno massello, caratterizzata da una cornice che contiene il top, con cassetti realizzati con tradizionale incastro a coda di rondine. La particolare lavorazione verticale dei frontali dei cassetti, Fresart, crea un effetto geometrico moderno e dinamico.

Qui, a sinistra e nelle successive noce senza nodi, finitura olio e frontali Fresart Sottile Noce.

*Chest of drawers in blockboard and solid wood, featuring a frame in which the top is recessed, with drawers assembled with traditional dovetail joints. The vertical processing of the fronts, Fresart, creates a modern and dynamic geometric effect.*

*In the pictures: oak without knots, fronts with Fresart Sottile Noce processing.*

*Kommode aus Tischlerplatte und Massivholz mit einem Rahmen, in dem die Platte eingelassen ist, und Schubladen mit traditionellen Schwalbenschwanzverbindungen. Die besondere vertikale Verarbeitung von den Fronten, Fresart, erzeugt einen modernen und dynamischen geometrischen Effekt.*

*In den Fotos: Nussbaum ohne Knoten, Fresart Sottile Noce Bearbeitung.*



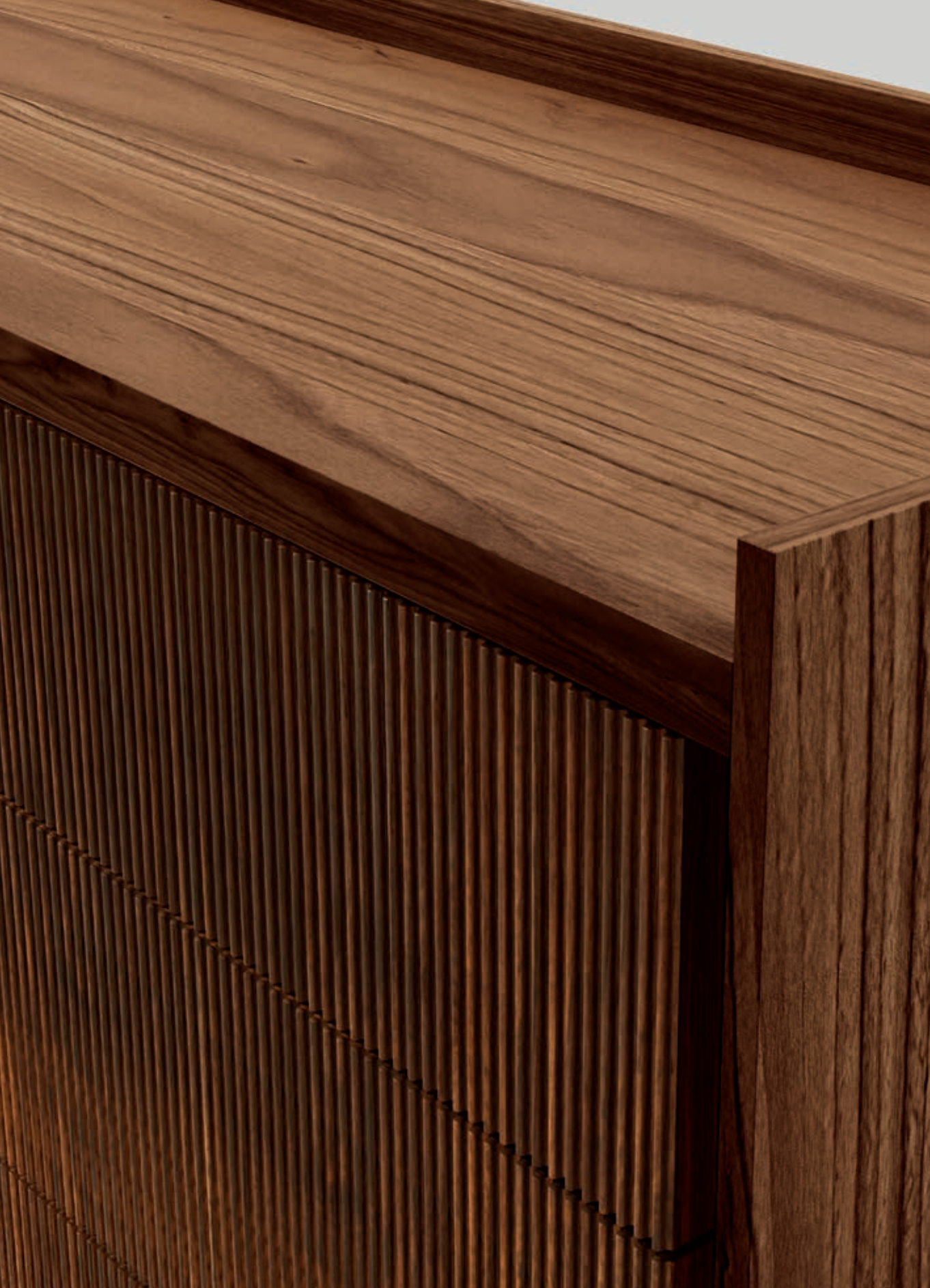



# RIALTO NIGHT FLY DRESSER

GIULIANO CAPPELLETTI



Cassettiera in listellare e legno massello, racchiusa da cornice in legno, con 4 cassetti realizzati con tradizionale incastro a coda di rondine. Qui, a sinistra: noce con nodi, finitura olio. Qui: Variante con top e maniglie in pelle Olimpia 015, basamento in ferro Irondust.

*Chest of drawers in blockboard and solid wood, with wooden frame and 4 drawers assembled with traditional dovetail joints. On this page and on the left: walnut with knots, oil finish. On this page: version with top and handles in leather Olimpia 015, iron base lacquered Irondust.*

*Kommode aus Tischlerplatte und Massivholz, mit Holzrahmen und 4 Schubladen mit traditioneller Schwalbenschanzverbindung gefertigt.*

*Auf dieser Seite und links: Nussbaum mit Knoten geölt. Auf dieser Seite: Variante mit Platte und Griffe aus Kernleder Olimpia 015, Gestell Irondust lackiert.*



CM: L. 120 · P. 50 · H. 80

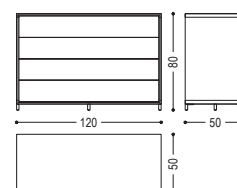





# FREEDOM

C.R.&S. RIVA1920



Comodino in legno massello, composto da moduli impilati realizzati con tradizionale incastro a coda di rondine. Disponibile nelle versioni con vano a giorno e/o con cassetto. Qui e a destra: noce senza nodi, finitura olio.

*Night table in solid wood, consisting of separate elements stacked one above the other, assembled with traditional dovetail joints. Available with open modules and/or with drawer. In the pictures: walnut without knots, oil finish.*

FREEDOM COM.1

CM: L. 38 · P. 38 · H. 39

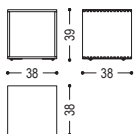

FREEDOM COM.2

CM: L. 38 · P. 38 · H. 39

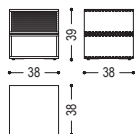

*Nachttisch aus Massivholz, bestehend aus unabhängige Module, die übereinander gestellt sind, mit traditioneller Schwalbenschwanzverbindung gefertigt. Mit offenen Modulen und/oder mit Schublade erhältlich.*

*In den Fotos: Nussbaum ohne Knoten geölt.*





## KYOTO 5

C.R.&S. RIVA1920



CM: L. 65 · P. 43 · H. 47

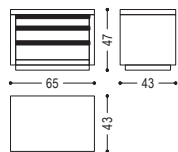

Comodino in listellare impiallacciato, con 3 cassetti con frontali in massello e realizzati con tradizionale incastro a coda di rondine. Qui e a sinistra: noce con nodi, finitura olio.

*Night table in veneered blockboard, with 3 drawers with fronts in solid wood and assembled with traditional dovetail joints. In the pictures: walnut with knots, oil finish.*

*Nachttisch aus furnierter Tischlerplatte, mit 3 Schubladen mit Fronten aus Massivholz und mit traditioneller Schwabenschanzverbindung gefertigt. In den Fotos: Nussbaum mit Knoten geölt.*



LIFE

100

THE DECOR

# NIGHT-NIGHT

TERRY DWAN



36.01.2/36.01.1

CM: L. 35/55 · P. 35 · H. 35

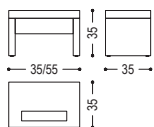

36.02.2/36.02.1

CM: L. 35/55 · P. 35 · H. 35

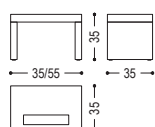

Comodino in listellare impiallacciato, caratterizzato da un comodo vano svuota tasche sul top. Disponibile con o senza cassetto, realizzato con tradizionale incastro a coda di rondine. Il frontale in massello ospita una fresata posta nella parte inferiore del cassetto per consentirne l'apertura. Qui e a sinistra: noce senza nodi, finitura olio.

*Night table in veneered blockboard, with a grooved spot on the top serving as a small tray. Available with or without drawer, assembled with traditional dovetail joints. The solid wood front features a groove on the bottom to allow opening. In the pictures: walnut without knots, oil finish.*

*Nachttisch aus furnierter Tischlerplatte, mit ausgefrästen Ablage auf der Oberfläche. Mit oder ohne Schublade, mit traditioneller Schwalbenschwanzverbindung erhältlich. Schubladenfront mit Griffmulde unten.*

*In den Fotos: Nussbaum ohne Knoten geölt.*



# REVO NIGHT TABLE

GIULIANO & GABRIELE CAPPELLETTI



REVO NIGHT TABLE 1.1  
CM: L. 50 · P. 45 · H. 54

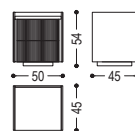

REVO NIGHT TABLE 1.2  
CM: L. 90 · P. 45 · H. 54

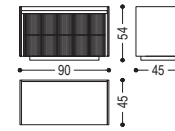

REVO NIGHT TABLE 2.1  
CM: L. 50 · P. 45 · H. 54

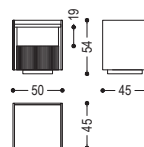

REVO NIGHT TABLE 2.2  
CM: L. 90 · P. 45 · H. 54

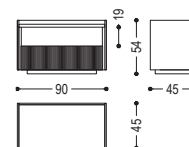

Comodino in listellare impiallacciato, caratterizzato da una cornice che contiene il top, con 2 cassetti con frontali, oppure 1 cassetto e 1 vano a giorno. Cassetti realizzati con tradizionale incastro a coda di rodine e frontali con particolare lavorazione verticale, Fresart, che crea un effetto geometrico moderno e dinamico.

Qui e a destra: noce senza nodi, finitura olio e frontali Fresart Sottile Noce.

*Night table in veneered blockboard, featuring a frame in which the top is recessed, available with 2 drawers or with 1 drawer and 1 open module. The drawers are assembled with traditional dovetail joints, while the vertical processing of the fronts, Fresart, creates a modern and dynamic geometric effect.*

*In the pictures: walnut without knots, finish with oil and fronts with Fresart Sottile Noce processing.*

*Nachttisch aus furnierter Tischlerplatte, mit einem Rahmen, in dem die Platte eingelassen ist, erhältlich mit 2 Schubladen oder mit 1 Schublade und 1 offenem Modul. Die Schubladen sind mit traditionellen Schwalbenschwanzverbindungen und die besondere vertikale Verarbeitung von den Fronten, Fresart, erzeugt einen modernen und dynamischen geometrischen Effekt.*

*In den Fotos: Nussbaum ohne Knoten, Fresart Sottile Noce Bearbeitung.*



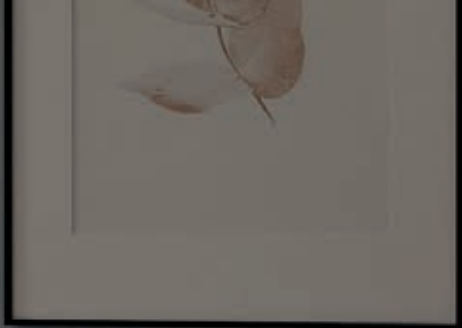

## RIALTO NIGHT

GIULIANO CAPPELLETTI



Comodino in listellare e legno massello, con 2 cassetti realizzati con tradizionale incastro a coda di rondine. Disponibile con struttura esterna in ferro oppure in legno.

Qui e a destra: struttura in ferro laccato Irondust e frontali in rovere senza nodi, finitura cera.

*Night table in blockboard and solid wood, with 2 drawers assembled with traditional dovetail joints. Available with external iron or wooden frame.*

*In the pictures: iron structure lacquered Irondust and fronts in oak without knots, wax finish.*

*Nachttisch aus Tischlerplatte und Massivholz, mit 2 Schubladen mit traditioneller Schwalbenschwanzverbindung gefertigt. Mit Außenstruktur aus Eisen oder Holz erhältlich.*

*In den Fotos: Eisenstruktur lackiert Irondust und Fronten aus Eiche ohne Knoten gewachst.*

CM: L. 50 · P. 40 · H. 37

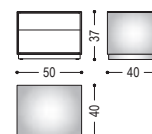





## RIALTO NIGHT FLY

GIULIANO CAPPELLETTI



CM: L. 50 · P. 40 · H. 38

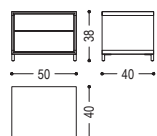

Comodino in listellare e legno massello, con 2 cassetti realizzati con tradizionale incastro a coda di rondine.

Qui e a sinistra: noce con nodi, finitura olio, basamento in ferro Irondust.

*Night table in blockboard and solid wood, with 2 drawers assembled with traditional dovetail joints.*

*In the pictures: walnut with knots, oil finish, iron base lacquered Irondust.*

*Nachtisch aus Tischlerplatte und Massivholz, mit 2 Schubladen mit traditioneller Schwalbenschanzverbindung gefertigt.*

*In den Fotos: Nussbaum mit Knoten geölt, Gestell Irondust lackiert.*





FINITURE

*FINISHES*

*AUSFÜHRUNGEN*

# LEGNO · WOOD · HOLZ

CATEGORIE · CATEGORIES · KATEGORIEN

A1

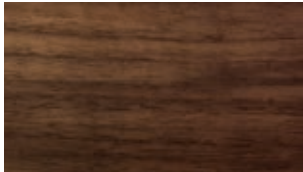

NOCE SENZA NODI  
WALNUT WITHOUT KNOTS  
NUSSBAUM OHNE KNOTEN



NOCE CON NODI  
WALNUT WITH KNOTS  
NUSSBAUM MIT KNOTEN

A2



ROVERE SENZA NODI  
OAK WITHOUT KNOTS  
EICHE OHNE KNOTEN



ROVERE CON NODI  
OAK WITH KNOTS  
EICHE MIT KNOTEN



CILIEGIO  
CHERRY  
KIRSCHBAUM



ACERO  
MAPLE  
AHORN

A4

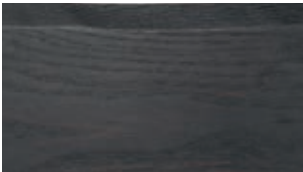

ROVERE SENZA NODI PIGMENTATO TOTAL BLACK\*  
TOTAL BLACK PIGMENTED OAK WITH/WITHOUT KNOTS \*  
EICHE MIT/OHNE KNOTEN TOTAL BLACK PIGMENTIERT \*

\*N.B.: L'immagine rappresenta la versione senza nodi · N.B.: The picture represents the version without knots · N.B.: im Bild Version ohne Knoten

A6



BRICCOLA

A7



CEDRO  
CEDAR  
ZEDER

A9

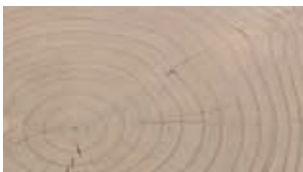

CEDRO FINITURA CONTRACT  
CEDAR CONTRACT FINISH  
ZEDER CONTRACT



CEDRO VULCANO  
VULCANO CEDAR  
ZEDER VULCANO

A10

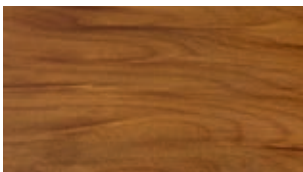

KAURI

A11



TEAK

# FERRO · IRON · EISEN

CATEGORIE · CATEGORIES · KATEGORIEN

B2



FERRO LACCATO IRONDUST  
IRONDUST LACQUERED IRON  
EISEN IRONDUST LACKIERT



RAL 3020 - ROSSO TRAFFICO  
RAL 3020 - TRAFFIC RED  
RAL 3020 - VERKEHRSROT

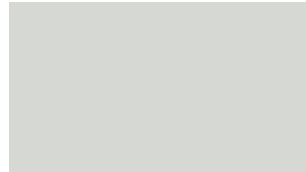

RAL 7035 - GRIGIO LUCE  
RAL 7035 - LIGHT GREY  
RAL 7035 - LICHTGRAU



RAL 7037 - GRIGIO POLVERE  
RAL 7037 - DUSTY GREY  
RAL 7037 - STAUBGRAU

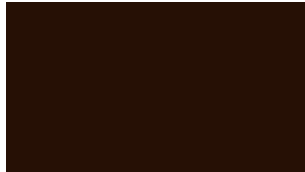

RAL 8019 - MARRONE GRIGIASTRO  
RAL 8019 - GREY BROWN  
RAL 8019 - GRAUBRAUN

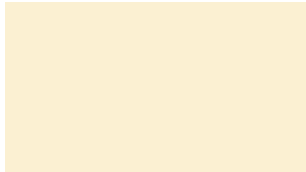

RAL 9001 - BIANCO CREMA  
RAL 9001 - CREAM WHITE  
RAL 9001 - CREMEWEISS

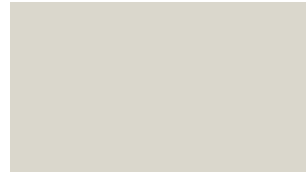

RAL 9002 - BIANCO GRIGIASTRO  
RAL 9002 - GREY WHITE  
RAL 9002 - GRAUWEISS

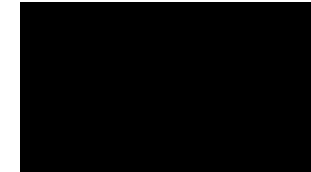

RAL 9005 - NERO INTENSO  
RAL 9005 - JET BLACK  
RAL 9005 - TIEFSCHWARZ

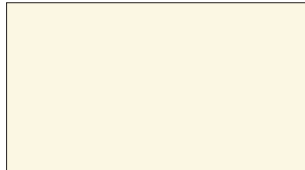

RAL 9010 - BIANCO PURO  
RAL 9010 - PURE WHITE  
RAL 9010 - REINWEISS

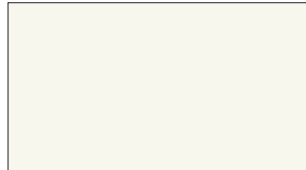

RAL 9016 - BIANCO TRAFFICO  
RAL 9016 - TRAFFIC WHITE  
RAL 9016 - VERKEHRSWEISS



RAL 1013 - BIANCO PERLA  
RAL 1013 - OYSTER WHITE  
RAL 1013 - PERLWEISS

B3



FERRO LACCATO EFFETTO BRONZO SPAZZOLATO OPACO  
LACQUERED IRON AGED COPPER MATT BRUSHED  
EFFECT  
EISEN LACKIERT, BRONZE-EFFEKT MATT GEBÜRSTET

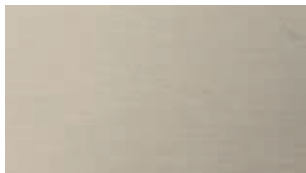

FERRO LACCATO EFFETTO ACCIAIO SPAZZOLATO OPACO  
LACQUERED IRON STAINLESS STEEL MATT BRUSHED  
EFFECT  
EISEN LACKIERT, EDELSTAHL-EFFEKT MATT GEBÜRSTET



FERRO LACCATO EFFETTO TITANIO SPAZZOLATO OPACO  
LACQUERED IRON TITANIUM MATT BRUSHED EFFECT  
EISEN LACKIERT, TITAN-EFFEKT MATT GEBÜRSTET

# PELLE / TESSUTO · LEATHER / FABRIC · LEDER/STOFFE

CATEGORIE · CATEGORIES · KATEGORIEN

TESSUTO BOUCLÈ M150 · FABRIC BOUCLÈ M150 · STOFF BOUCLÈ M150



01 SENAPE

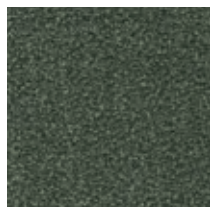

03 BOSCO



04 ERBA



06 MATTONE

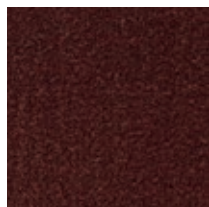

07 TERRA

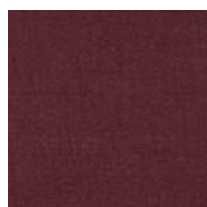

08 AMARANTO



11 BLU



12 AZZURRO



15 GRIGIO PERLA



17 GRIGIO

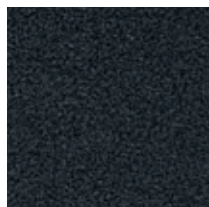

18 NERO



20 MARRONE

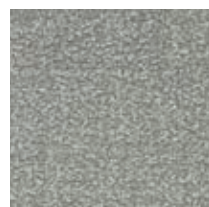

24 TORTORA



26 ECRU

TESSUTO MILANO M107 · FABRIC MILANO M107 · STOFF MILANO M107



01 ECRU



02 TORTORA



05 ORIONE



06 AZZURRO



07 FIORITO



09 VERDE



19 BLU

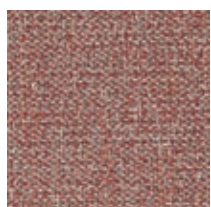

20 MATTONE



22 GHIACCIO

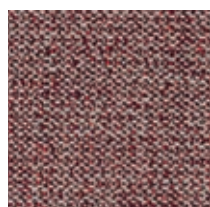

25 AMARANTO

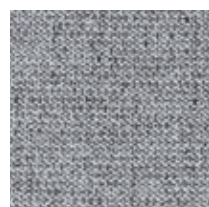

26 NERO

D1

TESSUTO TOKYO M115 · FABRIC TOKYO M115 · STOFF TOKYO M115



05 ERBA



06 BOSCO



08 JEANS



09 BLU



11 PERLA

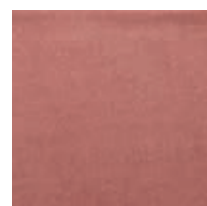

14 ROSSO

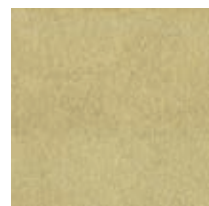

23 SENAPE

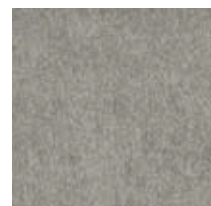

29 NOCCIOLA



31 AMARANTO



34 TORTORA



37 MARRONE

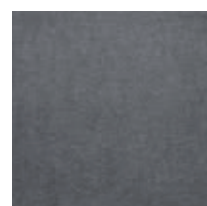

38 NERO

D1

TESSUTO CANVAS · FABRIC CANVAS · STOFF CANVAS



114

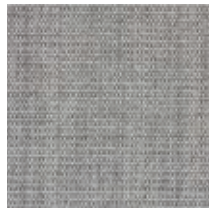

124



134



154

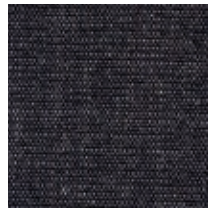

174

D2

TESSUTO MAPLE · FABRIC MAPLE · STOFF MAPLE



112 POLVERE



132 NEBBIA



142 PANDA



162 FUMO



192 GRAFITE



222 SAND



232 LIGHT BROWN

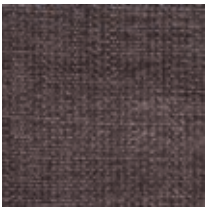

362 BROWN



742 JEANS



792 ORIONE

D3

PELLE CAMOSCIO · LEATHER CAMOSCIO · LEDER CAMOSCIO



1



10



11



26



27



28



31

PELLE CRISTAL · LEATHER CRISTAL · LEDER CRISTAL

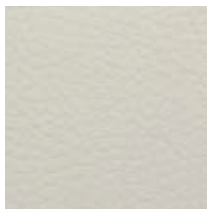

18



70

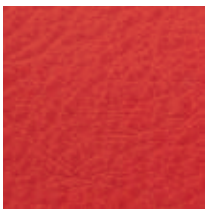

37

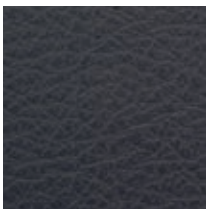

13



65



49



17



51

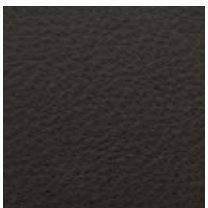

14

PELLE NABUK · LEATHER NABUK · LEDER NABUK



101



102



103



104

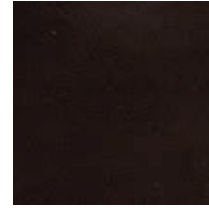

105

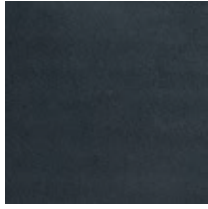

106

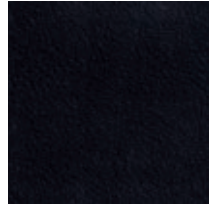

107



108

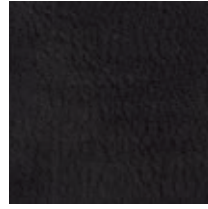

109

D4

PELLE UTAH · LEATHER UTAH · LEDER UTAH



101



102



103

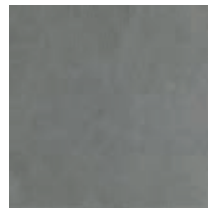

104



105



106

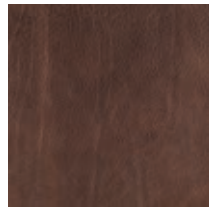

107

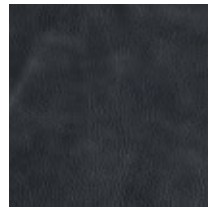

108

CUOIO OLIMPIA · LEATHER OLIMPIA · KERNLEDER OLIMPIA

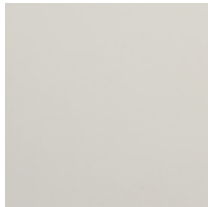

002

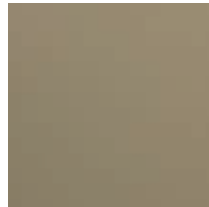

003



008

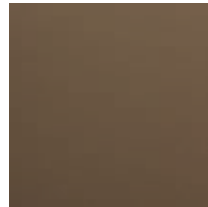

009



010

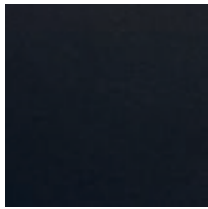

012



013



015

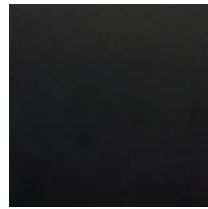

017

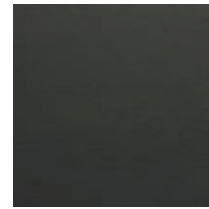

018

D5

TESSUTO OUTDOOR PATIO · OUTDOOR FABRIC PATIO · OUTDOOR-STOFF PATIO

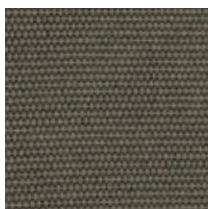

150

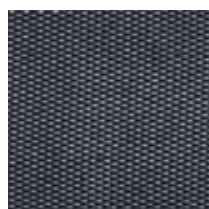

170

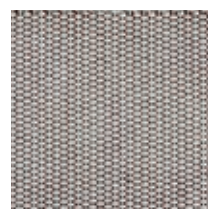

220



230

# VETRO · GLASS · GLAS

CATEGORIE · CATEGORIES · KATEGORIEN

E1	 VETRO TRASPARENTE / EXTRA CHIARO CLEAR GLASS / EXTRA CLEAR GLASS KLARGLAS	 VETRO SATINATO SATIN GLASS SATINIERTES GLAS
E2	 VETRO FUMÉ SMOKED GLASS RAUCHGLAS	 VETRO BRONZATO BRONZED GLASS BRONZIERTES GLAS

# ALTRI MATERIALI · OTHER MATERIALS · WEITERE MATERIALIEN

CATEGORIE · CATEGORIES · KATEGORIEN

F1	 MARMO EMPERADOR DARK EMPERADOR DARK MARBLE MARMOR EMPERADOR DARK	 MARMO VERDE ALPI VERDE ALPI MARBLE MARMOR VERDE ALPI	 GRES SAHARA NOIR STONEWARE SAHARA NOIR FEINSTEINZEUG SAHARA NOIR
----	---	---	--

\***N.B.:** Riferimento Dekton classe 2. Altri colori disponibili a richiesta.  
 \***N.B.:** Reference Dekton class 2. Other colours available upon request.  
 \***N.B.:** Dekton Kat. 2. Andere Farben erhältlich auf Anfrage.

F2	 MARMO CALACATTA CALACATTA MARBLE MARMOR CALACATTA
----	--

# LAVORAZIONE FRESART · FRESART PROCESSING · FRESART BEARBEITUNG

	 FRESART SOTTILE NOCE FRESART SOTTILE WALNUT FRESART SOTTILE NUSSBAUM	 FRESART MEDIA NOCE FRESART MEDIA WALNUT FRESART MEDIA NUSSBAUM	 FRESART MOSSA NOCE FRESART MOSSA WALNUT FRESART MOSSA NUSSBAUM
	 FRESART SOTTILE ROVERE FRESART SOTTILE OAK FRESART SOTTILE EICHE	 FRESART MEDIA ROVERE FRESART MEDIA OAK FRESART MEDIA EICHE	 FRESART MOSSA ROVERE FRESART MOSSA OAK FRESART MOSSA EICHE

Tutti i campioni, così come le foto dei vari materiali e delle finiture disponibili, sono da considerarsi puramente indicativi. Eventuali difformità di colore e caratteristiche dei materiali usati per la produzione non potranno essere considerate motivo di contestazione, poiché legate alle loro caratteristiche naturali (es. venatura e nodi del legno, conformità del ferro o di pelli e tessuti etc.) o all'artigianalità della lavorazione. Per ulteriori informazioni si prega di consultare l'allegato "A" alle nostre Condizioni Generali di Vendita, scaricabile dall'area riservata del nostro sito [www.riva1920.it](http://www.riva1920.it).

All samples, as well as pictures of the available materials and finishes, are to be considered as purely indicative. Possible differences in colour and features of the materials used for production cannot be considered as reason for claim, because linked to their natural characteristics (e.g. wood grain and knots, aspect of the iron or of leather and fabric etc.) or to the handcraft. For any further information you are kindly invited to read the Annex "A" to our General Sales Conditions, that can be downloaded from the reserved area of our website [www.riva1920.it](http://www.riva1920.it).

Alle Muster sowie Abbildungen dienen nur zur Veranschaulichung. Abweichungen bzgl. Farbe und Struktur der verwendeten Stoffe sind natur- und produktionsbedingt und können nicht als Mangel geltend gemacht werden. Für mehr Infos unsere allgemeinen Verkaufsbedingungen und Annex "A" unter LOGIN in unserer Webseite [www.riva1920.it](http://www.riva1920.it) einlesen.

# TARGHETTE DI IDENTIFICAZIONE PERSONALIZZATE

Riva 1920 offre la possibilità di realizzare targhette di identificazione in metallo che verranno apposte sui propri prodotti con laseratura del logo del cliente, previa richiesta specifica al momento dell'invio dell'ordine.

## *CUSTOMIZED IDENTIFICATION PLATES*

*Riva 1920 offers the possibility to have customized metal plaques which will be placed on its products with a personalized customer's logo engraving, upon specific request when placing the order.*

## *PERSONALISIERTE KENNZEICHNUNGSSCHILDER*

*Riva 1920 bietet die Möglichkeit, individuelle Plaketten mit Kundenlogo zu bekommen, die auf die Produkte angebracht werden, falls es auf der Bestellung deutlich angegeben wird.*



# SET MANUTENZIONE

Ogni prodotto è corredato da un set contenente uno specifico kit di trattamento in base al tipo di legno e alla finitura e le istruzioni per la manutenzione ordinaria.

## MAINTENANCE SET

*Each product is always sent along with a maintenance kit specific for the wood and finish of that product, also containing the instructions for ordinary maintenance.*

## PLEGESET

*Ein Pflegeset und Gebrauchsanleitungen werden immer mit jedem Produkt mitgeliefert.*



# NATURAL LIVING

## LA NOSTRA FILOSOFIA DEL "VIVERE NATURALE"

Ogni cliente che acquista un prodotto Riva 1920, riceve in omaggio un piccolo alberello, coltivato a partire dal seme in vivai appositamente creati, da piantare nel giardino di casa, in un bosco oppure in un parco. Per chi non sarà in grado di mettere a dimora la piantina, Riva 1920 ha pensato anche "all'adozione a distanza". Per partecipare al progetto Natural Living è sufficiente compilare il modulo scaricabile dal sito internet [www.riva1920.it](http://www.riva1920.it) e presentarlo al momento dell'acquisto presso il punto vendita autorizzato. Con questo semplice gesto il ciclo della natura non si interrompe, prendersi cura dell'ambiente deve diventare uno stile di vita ed un impegno concreto per la salvaguardia delle prossime generazioni.

## OUR PHILOSOPHY OF "LIVING NATURALLY"

*Upon request those who buy a product of Riva 1920's collection will receive a gift of a little seed-grown tree cultivated in specially created nurseries, to be planted in a garden, in a wood or in a park. For those who, while supporting the initiative, cannot plant this gift because they do not have a suitable space, Riva 1920 will arrange "long-distance adoption". In order to take part to our Natural Living Initiative, please download the form in our web site [www.riva1920.it](http://www.riva1920.it) and take it to the official Riva 1920 authorized retailer when buying a product. With this simple gesture the cycle of nature doesn't stop, taking care of the environment must become a lifestyle and a concrete commitment to preservation for future generations.*

## UNSERE PHILOSOPHIE VON „NATÜRLICH LEBEN“

*Jeder Kunde, der ein Produkt von Riva 1920 erwirbt, erhält als Geschenk einen kleinen Baum, der eigens zu diesem Zweck aus einem Samen in einer Baumschule gezüchtet wurde und im eigenen Garten, in einem Wald oder Park gepflanzt werden kann. Wer das Bäumchen nicht pflanzen kann, hat die Möglichkeit, mit Riva 1920 eine „Patenschaft“ zu vereinbaren. Um am Projekt Natural Living teilzunehmen, einfach das Formular von der Internetseite [www.riva1920.it](http://www.riva1920.it) herunterladen und dieses beim Kauf dem autorisierten Händler vorlegen. Durch diese einfache Geste wird der Naturkreislauf nicht unterbrochen. Die Pflege der Natur muss zu einem Lebensstil und einer konkreten Verpflichtung werden, um die nächsten Generationen zu schützen.*



L'immagine proposta è puramente indicativa - The image is purely for information - Das Bild ist nicht verbindlich

# DESIGN ECO

Abitare secondo natura - Più attenzione all'ambiente nei materiali e nei modi di produrre per non sprecare le potenzialità che ogni prodotto naturale ha in sé.

Nel petto dell'azienda batte un cuore fatto di legno. Riva 1920 ama la natura, ma anche i suoi clienti ed è per questo che offre un prodotto autentico fatto in vero legno naturale nel pieno rispetto dell'ambiente e delle persone che lo abitano. Rivestimenti, colle, vernici, mobili e molti altri elementi e oggetti di uso quotidiano presenti nelle nostre case, sono accomunati dal contenere formaldeide, un gas incolore dai numerosi derivati e dalle mille proprietà: un potente battericida e disinfettante ma anche un fissativo di uso comune, nonché un ottimo conservante. Peccato però che l'esposizione prolungata alla formaldeide, le cui molecole tendono con il tempo ad essere rilasciate nell'ambiente circostante, sia potenzialmente tossica facendone uno dei più diffusi inquinanti di interni; basti pensare che è stata inserita nell'elenco delle sostanze cancerogene per l'uomo. Proprio per questo motivo da oltre 30 anni Riva 1920 si impegna quotidianamente per garantire la naturalità dei suoi prodotti al fine di assicurare la massima qualità dell'aria indoor necessaria per il benessere fisico di tutta la famiglia.

*Living according to the nature - More attention to the environment through the use of materials and methods of production to avoid wasting the potential that every natural product has.*

*In the company's chest beats a wooden heart. Riva 1920 loves nature, and so do its customers; that's why it offers an authentic product in real natural wood, respecting the environment and the people who live in it. Upholstery, glues, paints, furniture and many other elements and everyday things in our homes contain formaldehyde, a colourless gas with various derivatives and with numerous features: a strong bactericide and disinfectant, but also a commonly used fixative and a good preservative.*

*Bad news is, a prolonged exposure to formaldehyde, whose molecules tend with time to be emitted into the surrounding environment, is potentially toxic, making it one of the most common interior pollutants; in fact it has been listed as one of the carcinogenic substances for the human being. That's why since more than 30 years Riva 1920 is daily committed to guarantee a natural product, in order to ensure good indoor air quality for the family well-being.*

*Naturgemäß leben - Der Umwelt bei Herstellungsweisen und Materialien mehr Aufmerksamkeit schenken, um das Potenzial von jedem natürlichen Produkt nicht zu verschwenden.*

*In der Brust des Unternehmens schlägt ein Herz aus Holz. Riva 1920 und auch seine Kunden lieben die Natur und daher wird ein echtes Produkt aus natürlichem Holz angeboten, das sowie die Natur als auch die Personen achtet. Verkleidungen, Klebstoffe, Lacke, Möbel und viele andere Elemente und Gegenstände des täglichen Gebrauchs unserer Häuser enthalten Formaldehyd, ein farbloses Gas zahlreicher Derivate und mit vielen Eigenschaften: ein wirkungsvolles keimtötendes und desinfizierendes Mittel, aber auch ein allgemein gebräuchliches Fixiermittel sowie ein ausgezeichnetes Konservierungsmittel. Es ist nur schade, dass eine langandauernde Formaldehyd-Exposition potentiell giftig ist, da seine Moleküle wieder in die Umgebung abgegeben werden, wodurch es zu einem der verbreitetsten verunreinigten Stoffe in Innenräumen zählt. Formaldehyd steht nämlich auf der Liste jener Substanzen, die für den Menschen krebserregend sind. Aus diesem Grund bemüht sich Riva 1920 seit über 30 Jahren täglich, die Natürlichkeit seiner Produkte zu garantieren, um die höchste Luftqualität in Innenräumen sicherzustellen, die für das Wohlbefinden der ganzen Familie wichtig ist.*



**DESIGN ECO** 



## RIVA CENTER

Il Riva Center è un edificio suggestivo totalmente ricoperto in legno di larice siberiano, inaugurato nel 2010. Il rivestimento è nato da un'idea progettuale dello studio Renzo Piano Building Workshop effettuato per l'università di Harvard.

## RIVA CENTER

*Riva Center is an amazing building completely covered with Siberian larch wood, built in 2010 based on from a project idea of the design studio Renzo Piano Building Workshop carried out for Harvard University.*

## RIVA CENTER

*Riva Center ist ein beeindruckendes Gebäude, das vollkommen mit sibirischem Lärchenholz verkleidet ist und 2010 eröffnet wurde. Die Verkleidung ist eine Projektidee vom Studio Renzo Piano Building Workshop und wurde für die Universität Harvard durchgeführt.*

## SHOWROOM

Al piano terra del Riva Center si trova uno Showroom di circa 1200 mq, che esalta l'essenza e l'unicità della collezione di arredi realizzati in vero legno massello. Lo spazio accoglie altresì una collezione di vecchie biciclette dei mestieri risalenti ai primi del 1900.

## SHOWROOM

*On the ground floor of Riva Center there is a Showroom of about 1200 square meters, which exalts the essence and uniqueness of the collection of solid wood furniture. The space also houses a collection of old bicycles of the crafts dating from the early 1900s.*

## SHOWROOM

*Im Erdgeschoss des Riva Centers befindet sich der Showroom, 1200 Quadratmeter, der die Eigenschaften und die Einmaligkeit der Produkte aus Massivholz betont. Hier ist auch eine Sammlung alter Fahrräder zu sehen, die Beginn des 20. Jahrhunderts als Fahrzeuge für unterschiedliche Berufe dienten.*





## MUSEO DEL LEGNO

Al primo piano dello stabile si trova il Museo del Legno, con un'esposizione di oltre 5.000 pezzi tra macchine ed utensili per la lavorazione del legno (datazione 1850/1930), collezione unica nel suo genere in Europa per la quantità di pezzi presenti. Obiettivo far riscoprire le origini e le tradizioni tipiche dell'ebanisteria, esponendo molti utensili provenienti da antiche botteghe artigiane italiane. Nell'ampio salone si trovano pialle, banchi da lavoro, torni, combinate, pultrici, seghe a nastro, bindelle: termini tecnici quasi dimenticati. Protagonista indiscusso dello spazio il tavolo "Antico" in legno millenario di Kauri datato 48.000 anni e lungo 12 metri, caratterizzato da una base in ferro disegnata dall'architetto Renzo Piano.

## MUSEUM OF WOOD

*On the first floor of the building there is the Museum of Wood, with an exhibition of over 5.000 pieces including woodworking machines and tools (dating back to 1850/1930), a unique collection of its kind in Europe for the quantity of pieces. The aim is to rediscover the typical origins and traditions of cabinet making, by exhibiting many tools coming from ancient Italian artisan shops. In the large hall there are planes, workbenches, lathes, combined machines, sanding machines, band saws: almost forgotten technical terms. The undisputed protagonist of the space is the "Antico" table made of millennial Kauri wood dated 48,000 years and 12 meters long, characterized by an iron base designed by the architect Renzo Piano.*

## HOLZMUSEUM

*Im ersten Stock des Gebäudes befindet sich das Holzmuseum mit über 5.000 Ausstellungsstücken, Maschinen und Werkzeugen zur Holzbearbeitung aus dem Zeitraum 1850/1930, eine einzigartig große Sammlung dieser Art in Europa. In der Ausstellung können der Ursprung und die typischen Traditionen der Kunstschlerei wiederentdeckt werden, dank der vielen Werkzeugen aus alten italienischen Schreinerwerkstätten. Im geräumigen Raum werden Hobel, Werk- und Drehbänke, Kombimaschinen, Poliermaschinen, Bandsägen gezeigt: Fachausdrücke, die fast in Vergessenheit geraten sind. Unbestrittene Hauptfigur dieses Raumes ist der Tisch "Antico" aus tausendjährigem Kauri-Holz, 48.000 Jahre alt und 12 Meter lang, der sich durch sein Gestell aus Eisenrohren auszeichnet, Design vom Architekten Renzo Piano.*

## PANGEA LAB

Al secondo piano si trova il Pangea Lab, spazio suggestivo realizzato in legno di abete e vetro che ospita il tavolo Pangea, simbolo di Expo 2015 a firma di Michele de Lucchi che si ispira all'unico continente che in origine si ritiene includesse tutte le terre emerse e che durante le successive ere geologiche si è diviso nei vari continenti. La superficie di 80 metri quadrati realizzata in Kauri, legno originario della Nuova Zelanda, è composta da 19 pezzi sagomati ed è sostenuta da 271 gambe realizzate in Briccola, pali di rovere recuperati della laguna di Venezia.

## PANGEA LAB

*On the second floor you find the Pangea Lab, an evocative space made of fir wood and glass that houses the Pangea table, a symbol of Expo 2015 designed by Michele de Lucchi, which is inspired to the supercontinent that consisted of the current continents joined together and that during the following geological eras started breaking up. The 80-square-meter surface made of Kauri, a wood coming from New Zealand, is made up of 19 shaped pieces and is supported by 271 legs made of Briccola, reused oak poles from the Venetian lagoon.*

## PANGEA LAB

*Im zweitem Stock ist Pangea Lab, ein eindrucksvoller Ort aus Fichtenholz und Glas in dem sich der Tisch Pangea befindet, Symbol der Expo 2015, der von Michele de Lucchi entworfen wurde und sich am einzigen Kontinent inspiriert, der zu Beginn das ganze Festland enthielt, welches sich in den nachfolgenden geologischen Epochen in die verschiedenen Kontinente getrennt hat. Er hat eine Oberfläche von 80 Quadratmetern und wurde aus Kauri hergestellt, dem aus Neuseeland stammenden Holz; er besteht aus 19 Formteilen, die durch 271 Tischbeine aus Briccola getragen werden, Eichenholzpfähle aus der Lagune von Venedig.*





## XILOTECA

Lungo le pareti dello spazio Pangea Lab si trova una xiloteca, una vera e propria seconda installazione museale all'interno del Riva Center, una raccolta minuziosa di circa 900 legni provenienti da tutto il mondo. Nelle sottostanti teche di vetro si trova selezione di materiali naturali, frutto della collaborazione con aziende del territorio. Si tratta di uno spazio didattico e formativo per far conoscere da vicino le lavorazioni ed i materiali attraverso l'organizzazione di workshop dedicati a studenti ed addetti al settore.

## XYLOTHEQUE

*Along the walls of the Pangea Lab space there is a xilothèque, a real second museum inside the Riva Center, a meticulous collection of about 900 woods coming from all over the world. In the underlying glass cases there is a selection of natural materials, the result of collaboration with local companies. It is an educational and training space to make the processes and materials known through the organization of workshops dedicated to students and other companies working in the region.*

## XYLOTHEK

*Entlang der Wände des Pangea Lab befindet sich eine Xylotek, eine echte zweite Museumsinstallation im Riva Center und eine sorgfältige Sammlung von etwa 900 Hölzern aus der ganzen Welt. In den darunter liegenden Glasvitrinen gibt es eine Auswahl natürlicher Materialien, die dank der Zusammenarbeit mit anderen lokalen Unternehmen ausgestellt werden können. Es handelt sich um einen Bildungs- und Trainingsraum, dessen Ziel ist die Materialien und die Prozesse durch Workshops für Studenten und Fachleute bekanntzumachen.*

# UNITÀ PRODUTTIVE

L'unità produttiva 1 è dedicata alla produzione di credenze, armadi, librerie, letti e complementi d'arredo; macchinari tecnologicamente avanzati si alternano a banchi da falegname e i processi industriali alle lavorazioni artigianali. Taglio, bordatura, incollaggio, impiallacciatura, pressatura, assemblaggio, oliatura, montaggio e controllo qualità: passaggi fondamentali per arrivare al mobile finito, sinonimo di qualità.

L'unità produttiva 2 dedicata alla produzione di tavoli in legno massello, in particolare di Kauri o di Briccola. Rastrelliere in ferro contengono i top pronti per essere lavorati; le tavole a liste incollate vengono fatte "riposare" per prevenire i naturali movimenti, quelle in Kauri vengono fotografate ed inserite in un apposito catalogo per la scelta dell'acquirente. Ciascuno è un pezzo unico.

L'unità produttiva 3, dedicata alla lavorazione del legno di cedro per la realizzazione di sgabelli, panche e tavolini. I tronchi nel piazzale antistante lo stabilimento sprigionano nell'aria un profumo caratteristico ed inebriante. Una ruspa li preleva e li porta all'interno della fabbrica per il taglio longitudinale a cui segue la fase di scortecciamento ed infine di definizione della forma del prodotto tramite una dima. Il blocco viene poi inserito nel centro di lavoro e al termine del processo di lavorazione si passa alla levigatura che rende la superficie liscia.

## PRODUCTION UNITS

**Production unit 1** is dedicated to the production of sideboards, wardrobes, bookcases, beds and accessories; cutting-edge technology together with carpenter's benches, industrial processes and craftsmanship. Cutting, edging, gluing, veneering, pressing, oiling, assembly and final quality control: these are the steps to get to the finished product, symbol of quality.

**Production unit 2** is instead dedicated to the production of solid wood tables and in particular those in Kauri or Briccola wood. Iron racks contain the tops ready to be worked; tops in glued lists are let to "rest" to prevent natural movements; Kauri slabs are photographed and showed to the customer in a dedicated catalogue. Each piece is unique.

**Production unit 3** is dedicated to the production of cedar wood products: stools, benches and small tables. The trunks stored in the yard in front of the production unit release a characteristic scent into the air. A bulldozer picks them up and takes them inside the factory for the longitudinal cut and the debarking phase, then the shape of the stool is traced through a template. The block is then put into the CNC machine and it is sanded to make the surface smooth.

## PRODUKTIONSSTÄTTE

Die **Produktionsstätte 1** stellt Kommoden, Schränken, Regale, Betten und Einrichtungsobjekte her. Technologisch fortschrittliche Maschinen neben traditionellen Tischlerbänken und industrielle Prozesse neben Handwerk. Schneiden, Kleben, Furnieren, Pressen, Montage, Ölen und schließlich Qualitätskontrolle: diese sind die Schritte bis zum fertigen Möbelstück, das zum Synonym für Qualität wird.

Die **Produktionsstätte 2** stellt Massivholztischen her, unter denen auch Tische aus Kauri und Briccole. Hier stehen immer Tischplatten zum Bearbeiten bereit. Tischplatten aus verleimten Leisten werden horizontal gelagert um eventuelle Holzbewegungen zu vermeiden. Kauriplatten werden fotografiert und dank einem speziellen Katalog den potenziellen Käufern angeboten. Jede Platte ist ein Unikat.

Schließlich verarbeitet die **Produktionsstätte 3** Zedernholz zur Herstellung von Hockern, Bänken und Couchtischen. Die Stämme werden auf dem Vorplatz der Produktionsstätte gelagert und erfüllen die gesamte Umgebung mit einer charakteristischen Duftnote. Ein Bulldozer nimmt sie auf und bringt sie für den Längsschnitt und die Entrindung in die Fabrik, danach wird die Form des Hockers durch eine Schablone auf der Oberfläche gezeichnet. Der Block wird dann in den CNC-Maschinen bearbeitet und per Hand geschliffen, wodurch die Oberfläche glatt wird.

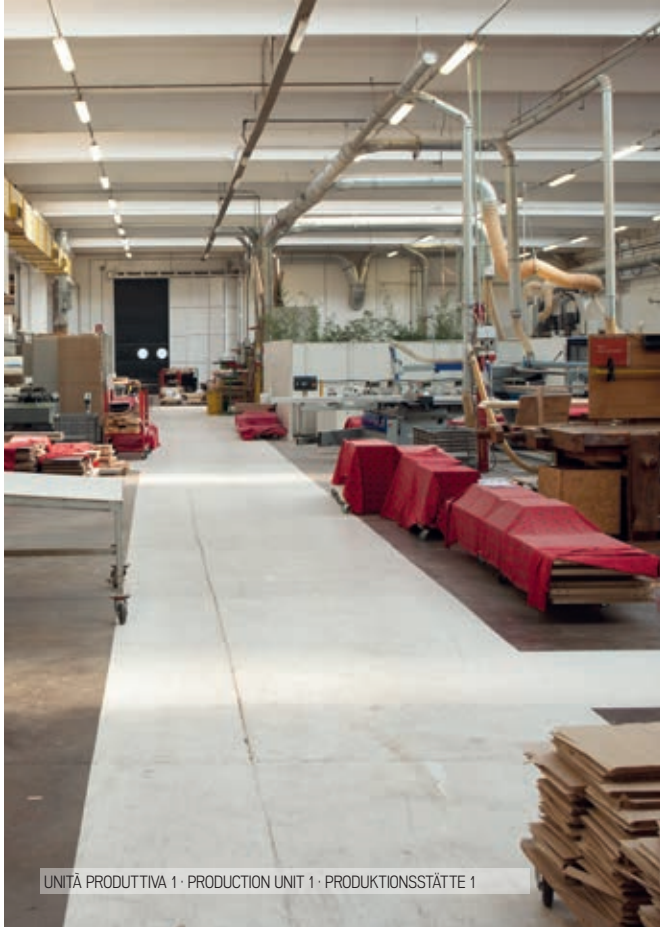

UNITÀ PRODUTTIVA 1 · PRODUCTION UNIT 1 · PRODUKTIONSSTÄTTE 1



UNITÀ PRODUTTIVA 2 · PRODUCTION UNIT 2 · PRODUKTIONSSTÄTTE 2



UNITÀ PRODUTTIVA 3 · PRODUCTION UNIT 3 · PRODUKTIONSSTÄTTE 3

ALDO CIBIC  
ALDO SPINELLI  
ALESSANDRO GUIDOLIN  
**ALESSANDRO MENDINI**  
AMEBE DESIGN STUDIO  
**ANDREA BRANZI**  
ANDREA CASTRIGNANO  
**BALDESSARI & BALDESSARI**  
BARTOLI DESIGN  
BENNO VINATZER  
BOYAN GRIGOROV  
**BRODIE NEILL**  
C.R.&S. RIVA 1920  
**CARLO COLOMBO**  
CENGIZ CIVAN  
**CLAUDIO BELLINI**  
**DANIEL GERMANI**  
**DAVID CHIPPERFIELD**  
DAVID DOLCINI  
DAVID KNOTT  
**ELIO FIORUCCI**  
**ENZO MARI**  
ERASMO FIGINI  
**FABIO NOVEMBRE**  
FABRIZIO ZAPPA  
FRANCIS KÉRÉ  
FRANCO & MATTEO ORIGONI  
GALIMBERTI & BIZZARRO  
GIOVANNA AZZARELLO  
GIOVANNI TOMASINI  
**GIULIANO & GABRIELE CAPPELLETTI**  
**GIULIANO CAPPELLETTI**  
GUALTIERO MARCHESI  
**HELIDON XHIXHA**  
HIKARU MORI  
HSIAO-CHING WANG  
ISABELLE RIGAL  
JAKE PHIPPS  
**JAMIE DURIE**  
**KARIM RASHID**

DESIGNERSFORRIVA1920

KARSTEN SCHMIDT-HOENSDORF  
KAZUYO KOMODA  
LUCA MARTORANO & MATTIA ALBICINI  
LUCA SCACCHETTI  
**LUISA CASTIGLIONI**  
**MARC SADLER**  
MARCO BAXADONNE  
**MARCO PIVA**  
MARIA SAADEH  
**MARIO BELLINI**  
**MARIO BOTTA**  
**MARIO CUCINELLA**  
**MATTEO THUN**  
**MICHELE DE LUCCHI**  
MICHELE TAVANO  
**NERI & HU**  
NESPOLI E NOVARA  
**PAOLA NAVONE**  
**PAOLO PIVA**  
PAOLO SALVADÈ  
PASSON & SAVORGNANI  
**PATRICIA URQUIOLA**  
PATRIZIA BOZUFFI  
**PIERO LISSONI**  
**PININFARINA**  
PINUCCIO SCIOLA  
REI HAMADA  
**RENZO & MATTEO PIANO**  
RICCARDO ARBIZZONI  
SAKURA ADACHI  
SETSU & SHINOBU ITO  
SOLONI, GRANDE, REVESZ  
**STEFANO BOERI**  
STEFANO LAROTONDA  
**STEVE LEUNG**  
STUDIO ZERO  
**TERRY DWAN**  
THOMAS HERZOG  
VEGNI DESIGN  
VENEZIANO+TEAM

COPYRIGHT © RIVA 1920  
ALL RIGHTS RESERVED.

ANY REPRODUCTION,  
REPRESENTATION  
OR MODIFICATION,  
IN FULL OR PARTLY, OF THIS  
CATALOGUE  
IS EXPRESSLY PROHIBITED.

FOR FURTHER INFORMATION  
PLEASE VISIT [www.riva1920.it](http://www.riva1920.it)



STYLING  
COMMUNICATION  
GRAPHIC DESIGN

**RIVA 1920**

PRINTED IN 2022  
**LA GRAFICA · CANTÚ**

PHOTO  
**MARCO BELLO**  
**STUDIO ELEVEN**  
**MODO FOTOGRAFIA**

Descriptions, colours and pictures of products included in this catalogue have an indicative value only and are not binding for products use. Riva 1920 reserves the right to modify their products without prior notification.

Riva 1920 è ora disponibile su scala globale in oltre 90 Paesi attraverso una rete di oltre 450 punti vendita autorizzati.  
*Riva 1920 is now globally available in more than 90 Countries with an authorized Dealer network of 450 Stores.*  
*Riva 1920 ist jetzt weltweit in mehr als 90 Länder vertriebt und zählt ungefähr 450 offizielle Händler.*

**1920 R<sup>®</sup>**  
**MADE IN ITALY**  
**GRÜN**  
**BECK**  
**DESIGNERS & INTERIORS**

interior architects | design stores  
all in one service | cabinet maker  
Margaretenstr.93 | A-1050 Wien  
interiors@gruenbeck.co.at  
+43 1 544 83 39

**RIVA 1920**

**Industria Mobili SPA**  
Via Milano, 137  
22063 Cantù  
Como · Italy  
T. +39 031 73 30 94  
F. +39 031 73 34 13  
info@riva1920.it

**Production unit - 1**  
Via Milano, 137  
22063 Cantù  
Como · Italy

**Production unit - 2**  
Via Genova, 13  
22063 Cantù  
Como · Italy

**Production unit - 3**  
Via Como, 74  
22066 Mariano C.se  
Como · Italy

**Riva Center**  
Via Milano, 110  
22063 Cantù  
Como · Italy

**Riva Farm**  
Cucciago  
Como · Italy