

SELF

Rimadesio

5 SELF SYSTEM
6 SELF, 22 SELF BOLD, 62 SELF UP, 98 SELF PLAN

rimadesio-wien.at

IT Il sistema Self è dotato di un'ampia varietà di soluzioni che assicurano la più completa funzionalità e la massima qualità estetica. Elementi a parete indipendenti in libero posizionamento: questa è la concezione progettuale di Self, che si declina in differenti versioni. Self Bold, il sistema d'arredo sospeso disponibile anche nella configurazione a madia, caratterizzato da fianchi e profilo posteriore in alluminio. Self up: le composizioni freestanding con piedini in alluminio, definite da un'estetica ispirata alla massima leggerezza formale. Self Plan si articola in composizioni sospese, in versione scrittoio e mobile living.

DE Das System Self bietet eine Vielzahl von Lösungen, die einen möglichst vollständigen Funktionsumfang abdecken und höchste ästhetische Qualität gewährleisten. Frei stehende Wandelemente: Das ist das Gestaltungskonzept, dem die verschiedenen Ausführungen von Self folgen. Self Bold: Hänge-Einrichtungssystem, auch in einer Sideboard-Konfiguration erhältlich, mit Seiten und rückwärtigem Profil aus Aluminium. Self Up: frei stehende Kompositionen mit Aluminiumfüßen mit einer von maximaler Leichtigkeit geprägten Ästhetik der Form. Self Plan: hängende Kompositionen, erhältlich in Büro- und Mobile-Living-Versionen.

FR Le système Self propose une grande variété de solutions, pour une fonctionnalité complète et une esthétique inégalée. Éléments muraux indépendants, librement positionnables: tel est le concept de Self, qui se décline en différentes versions. Self bold, le système de meubles suspendus, est également disponible en configuration bahut, avec panneaux latéraux et profil arrière en aluminium. Self up: les compositions autoportantes avec pieds en aluminium, dont l'esthétique s'inspire de formes aériennes. Self Plan se décline en compositions suspendues, en version bureau et meuble de salon.

ES El sistema Self está equipado con una amplia variedad de soluciones que aseguran la más completa funcionalidad y la máxima calidad estética. Elementos murales independientes y de libre posicionamiento: este es el concepto de diseño de Self, que se presenta en diferentes versiones. Self Bold, el sistema de muebles suspendidos también disponible como aparador, caracterizado por tener los laterales y el perfil trasero de aluminio. Self up: las composiciones autoportantes con patas de aluminio, definidas por una estética inspirada en la máxima ligereza formal. Self Plan se articula en forma de composiciones suspendidas, en versión escritorio y salón.

RU В систему Self внедрен широкий спектр решений, которые обеспечивают полную функциональность и высочайшее эстетическое качество. Свободно стоящие у стены компоненты — такова концепция дизайна Self, представленная в различных вариантах. Self bold — навесная мебельная система также доступна в конфигурации тумбы, характеризующейся боковыми стенками и задним профилем из алюминия. Self up: отдельностоящие композиции с алюминиевыми ножками, определяемые эстетикой, вдохновленной максимальной легкостью. Self Plan: воплощен в навесных композициях, в виде письменного стола и мебели для гостиной.

汉语 Self 系统提供各式各样解决方案, 确保最完整的功能性与美学品质。“Self”的设计理念体现在各式不同的版本中, 即: 可任意自由摆放的独立式墙面元素。 Self bold 悬挂式家具系统亦提供餐具柜的配置, 以铝合金打造的侧板以及后方轮廓尤为特色。 Self up: 附有铝合金支脚的独立式组合, 美学灵感源于造型上极度轻盈的感受。 Self Plan 以悬吊式组合构成, 有办公桌和客厅家具的版本。

THE SELF SYSTEM IS EQUIPPED WITH A WIDE VARIETY OF SOLUTIONS THAT ENSURE THE MOST COMPREHENSIVE FUNCTIONALITY AND THE MAXIMUM AESTHETIC QUALITY. THE DESIGN CONCEPT OF SELF IS ENCAPSULATED BY FREESTANDING INDEPENDENT WALL ELEMENTS, COMING IN DIFFERENT VERSIONS. SELF BOLD, THE SUSPENDED FURNITURE SYSTEM ALSO AVAILABLE IN THE SIDEBOARD CONFIGURATION, FEATURES ALUMINIUM SIDES AND REAR PROFILE. SELF UP: THE FREESTANDING COMPOSITIONS WITH ALUMINIUM FEET, DEFINED BY AN AESTHETIC INSPIRED BY MAXIMUM FORMAL LIGHTNESS. SELF PLAN IS OFFERED IN SUSPENDED COMPOSITIONS, IN THE DESK AND LIVING VERSIONS.



A MODULAR SYSTEM THAT ALLOWS TO CREATE SINGLE AND DOUBLE-SIDED SIDEBOARDS, WALL-MOUNTED COMPOSITIONS, CONTAINERS FOR DOMESTIC AND PUBLIC SPACES. A VERSATILE PROJECT BASED ON HORIZONTAL AND VERTICAL MODULARITY, WITH STORAGE ELEMENTS, DRAWERS, FLAP DOORS, SHOWCASE, WITH HINGED DOORS AND WITH OPEN UNITS.

IT Un sistema componibile che permette di creare medie mono e bifacciali, composizioni sospese a parete, contenitori per la casa e per gli spazi extra domestici. Un progetto versatile, basato su una modularità orizzontale e verticale, con elementi contenitori a cassetti, ribalta, vetrina, con ante battente e con vani a giorno.

DE Ein modulares System, das es ermöglicht, ein- und beidseitige Sideboards, wandhängende Kompositionen sowie Aufbewahrungslösungen für das Zuhause und außerhäusliche Räume zu kreieren. Ein vielseitiges Design, basierend auf horizontaler und vertikaler Modularität, mit Aufbewahrungslösungen mit Schubladen, Klapptür oder Vitrine, mit Flügeltüren und offenen Fächern.

FR Un système modulaire qui permet de créer des bahuts à simple et double face, des compositions murales suspendues et des systèmes de rangement pour la maison et autres espaces. Un projet polyvalent, basé sur une modularité horizontale et verticale, à travers des éléments de rangements avec tiroirs, abattants, vitrines, portes battantes et compartiments ouverts.

ES Un sistema modular que permite crear aparadores de una y doble cara, composiciones suspendidas de pared, contenedores para el hogar y para espacios no domésticos. Un proyecto versátil, basado en la modularidad horizontal y vertical, con elementos contenedores con cajones, solapa, vitrina, con puertas batientes y compartimentos abiertos.

RU Модульная система, позволяющая создавать одно- и в слове двусторонний X нет тумбы, навесные композиции, шкафы для хранения вещей в доме и в помещениях иного назначения. Универсальный дизайн, основанный на горизонтальной и вертикальной модульности, с ящиками, створками, витринами, распашными дверями и открытыми отделениями.

汉语 这套模块化系统可创造出单面或双面版本的餐具柜、壁挂式组合柜、居家储物柜以及居家之外的各式空间。水平和垂直的模块化是这款多功能设计的基础，其中包括收纳抽屉、翻门、玻璃展示柜、铰链门和开放式收纳格等元素。



Structure: 13 nero
Top, sides and fronts: 46 nero lucido
Flap door cabinet: 00 trasparente
Cabinet internal sides and back panel: 102 nero opaco
Cabinet internal base in synthetic leather: 154 argilla
W 3850 H 325 D 494

In this photo
Wall panelling system: Modulor



Structure: 13 nero
Top, sides and fronts: 46 nero lucido
Flap door cabinet: 00 trasparente
Cabinet internal sides and back panel: 102 nero opaco
Cabinet internal base in synthetic leather: 154 argilla
W 3850 H 325 D 494

In this photo
Wall panelling system: Modulor
Coffee table: Sixty

EN The Self system is available in suspended compositions that can be integrated into the Modulor boiserie with maximum design freedom. The horizontal display containers feature a transparent top with contrasting internal finishings, enhanced by a dimmable LED lighting system. The front glass door comes with an exclusive opening mechanism.

IT Il sistema Self si declina in composizioni sospese integrabili nella boiserie Modulor con la massima libertà progettuale. I contenitori vetrina orizzontali sono trasparenti nella parte superiore, con finiture interne a contrasto e valorizzate da un sistema di illuminazione a led dimmerabile. L'anta a vetro frontale presenta un meccanismo di apertura esclusivo.

DE Das System Self besteht aus hängenden Kompositionen, die mit maximaler Gestaltungsfreiheit in die Modulor-Vertäfelung integriert werden können. Die horizontalen Vitrinen sind im oberen Bereich transparent, haben kontrastierende Innenflächen und werden durch ein dimmbares LED-Beleuchtungssystem in Szene gesetzt. Die vordere Glastür verfügt über einen einzigartigen Öffnungsmechanismus.

FR Le système Self est disponible en compositions suspendues intégrables aux boiseries Modulor avec une liberté de conception maximale. La partie supérieure des vitrines horizontales est transparente, avec des finitions intérieures contrastées et valorisées par un système d'éclairage LED avec capteur. La porte vitrée est dotée d'un mécanisme d'ouverture exclusif.

ES El sistema Self está disponible en composiciones suspendidas que se pueden integrar en el revestimiento Modulor con la máxima libertad de diseño. Los contenedores con vitrina horizontales son transparentes en la parte superior, con acabados internos en contraste y realizados por un sistema de iluminación LED regulable. La puerta frontal de cristal cuenta con un mecanismo de apertura exclusivo.

RU Система Self состоит из подвесных композиций, которые могут быть интегрированы в буазери Modulor при максимальной свободе сочетаний. Горизонтальные витрины характеризуются прозрачной верхней частью, контрастной внутренней отделкой и системой светодиодной подсветки с регулируемой яркостью. Передняя стеклянная дверь оборудована уникальным механизмом открывания.

汉语 Self 系统由悬吊式的组合柜构成可与 Modulor 系统的护墙板相结合, 为设计带来最大程度的灵活性。横向的玻璃展示柜上部是透明的, 内部的各式表面处理呈现出鲜明的对比, 配备可调光的 LED 照明系统。前玻璃门扇具有独特的开启装置。



Structure: 13 nero
Top, sides and fronts: 46 nero lucido
Flap door cabinet: 00 trasparente
Cabinet internal sides and back panel: 102 nero opaco
Cabinet internal base in synthetic leather: 154 argilla
W 3850 H 325 D 494

In this photo
Wall panelling system: Modulor





Structure: 58 caffè
Glass: 819 caffè taiga
W 650 H 1319 D 485

Structure: 142 sandalo
Glass: 809 sandalo taiga
W 1930 H 519 D 485

SELF



Structure: 142 sandalo
Glass: 809 sandalo taiga
W 1930 H 519 D 485



Structure: 304 platino
Glass: 108 bianco latte opaco
Open modules: 15 noce
W 4810 H 325 D 488

In this photo
Suspended cabinets: Alambra
Coffee tables: Tray



Structure: 304 platino
Glass: 108 bianco latte opaco
Open modules: 15 noce
W 4810 H 325 D 488



FLOOR STANDING, WITH FEET OR SUSPENDED, SELF BOLD IS THE SYSTEM THAT EXPRESSES THE ESSENTIALITY AND CONTEMPORANEITY OF RIMADESIO. ABSOLUTE GEOMETRIES AND THE ABILITY TO DIALOGUE WITH OTHER COLLECTIONS ALLOW SELF BOLD TO FIT INTO THE LIVING SPACE WITH PERSONALITY.

IT A terra, con piedini o sospeso, Self Bold è il sistema che esprime l'essenzialità e la contemporaneità di Rimadesio. Geometrie assolute e capacità di dialogare con altre collezioni permettono a Self Bold di inserirsi con personalità nello spazio living.

DE Ob auf dem Boden stehend, mit Füßen oder hängend, Self Bold bringt das Wesen und die ganze Gegenwartigkeit von Rimadesio zum Ausdruck. Absolute Geometrien und die Dialogfähigkeit mit anderen Kollektionen ermöglichen es Self Bold, sich in Wohnräume einzufügen, ohne dabei an eigener Persönlichkeit zu verlieren.

FR Au sol, sur pieds ou suspendu, Self Bold est un système qui exprime pleinement l'esprit épuré et contemporain de Rimadesio. Géométries absolues et capacité à dialoguer avec d'autres collections permettent à Self Bold de s'intégrer avec personnalité dans l'espace de vie.

ES En el suelo, con patas o suspendido, Self Bold es el sistema que expresa la esencialidad y la contemporaneidad de Rimadesio. Las geometrías absolutas y la capacidad de dialogar con otras colecciones permiten a Self Bold integrarse en el espacio habitable con personalidad.

RU Напольные, на ножках или навесные изделия, Self Bold - это система, полностью отображающая сущность и современность компании Rimadesio. Абсолютная геометрия и возможность сочетания с другими коллекциями позволяют Self Bold идеально вписаться в жилое пространство.

汉语 无论是带支脚的落地式、悬挂式还是悬挂式的版本, Self Bold 系统都体现出 Rimadesio 纯粹的本质以及当代性。Self Bold 的绝对几何性以及与其他系列的易于搭配性为客厅空间增添鲜明个性。



EN The new Self system drawers feature a thin metal structure with a thickness of 12 mm, equipped with a push opening system including cushioned closing movement.

IT Gli inediti cassetti del sistema Self presentano una struttura in metallo sottile con spessore 12 mm, dotati di un sistema di apertura push con movimento di chiusura ammortizzato.

DE Die neuen Schubladen des Self-Systems haben einen dünnen Metallrahmen mit einer Stärke von 12 mm und sind mit Push-to-Open und einer gedämpften Schließbewegung ausgestattet.

FR Les tous nouveaux tiroirs du système Self se caractérisent par leur fine structure métallique de 12 mm d'épaisseur, et sont équipés d'un système d'ouverture à pression avec mouvement de fermeture amorti.

ES Los nuevos cajones del sistema Self cuentan con una fina estructura metálica de 12 mm de espesor, equipada con un sistema de apertura push con movimiento de cierre amortiguado.

RU Уникальные ящики системы Self характеризуются тонким металлическим каркасом толщиной 12 мм и оснащены системой открывания с нажимным механизмом и плавным закрыванием.

汉语 Self 系统的新型抽屉采用 12 毫米厚的薄金属框架，配备软关闭功能的推弹开启系统。



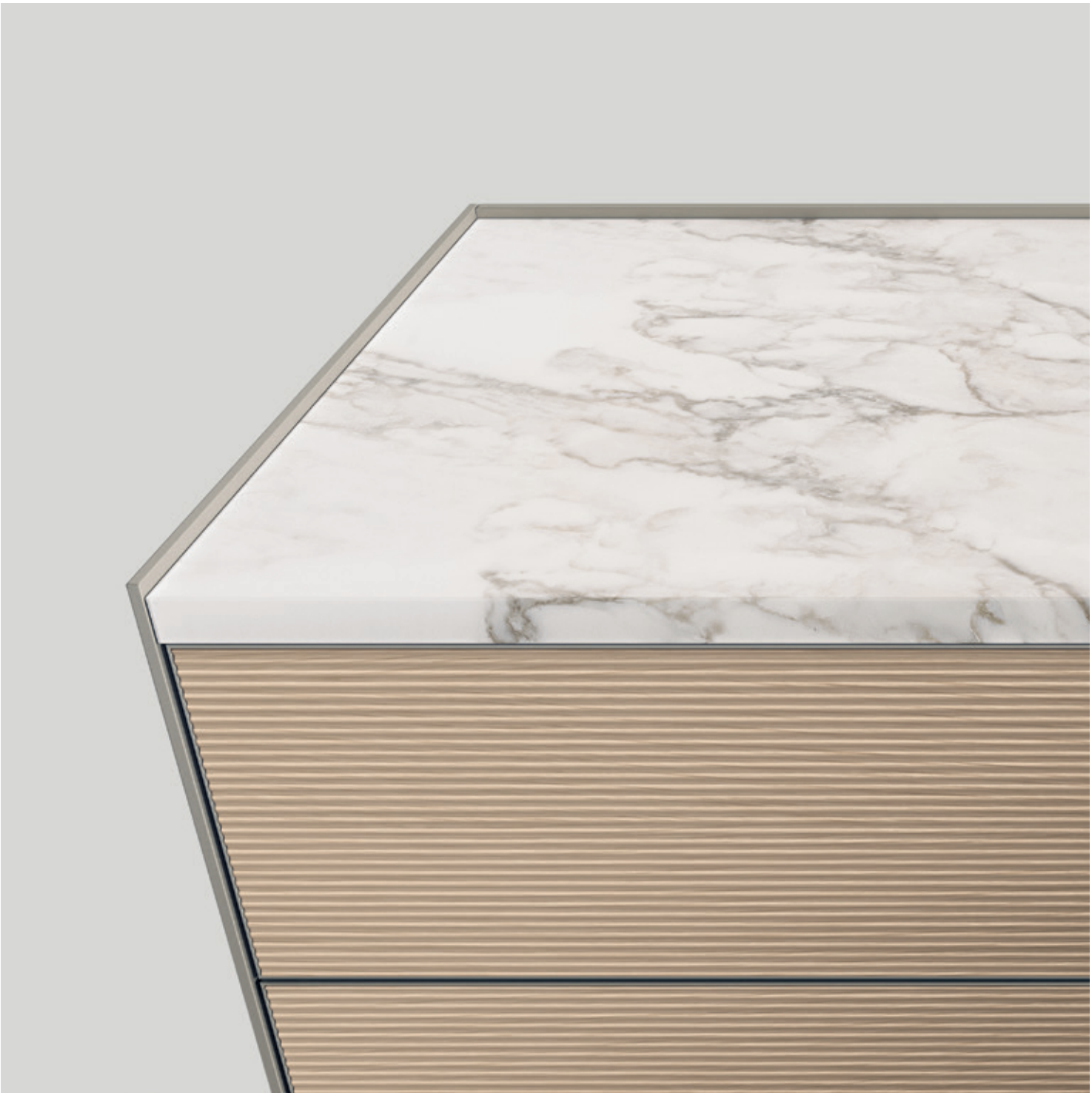
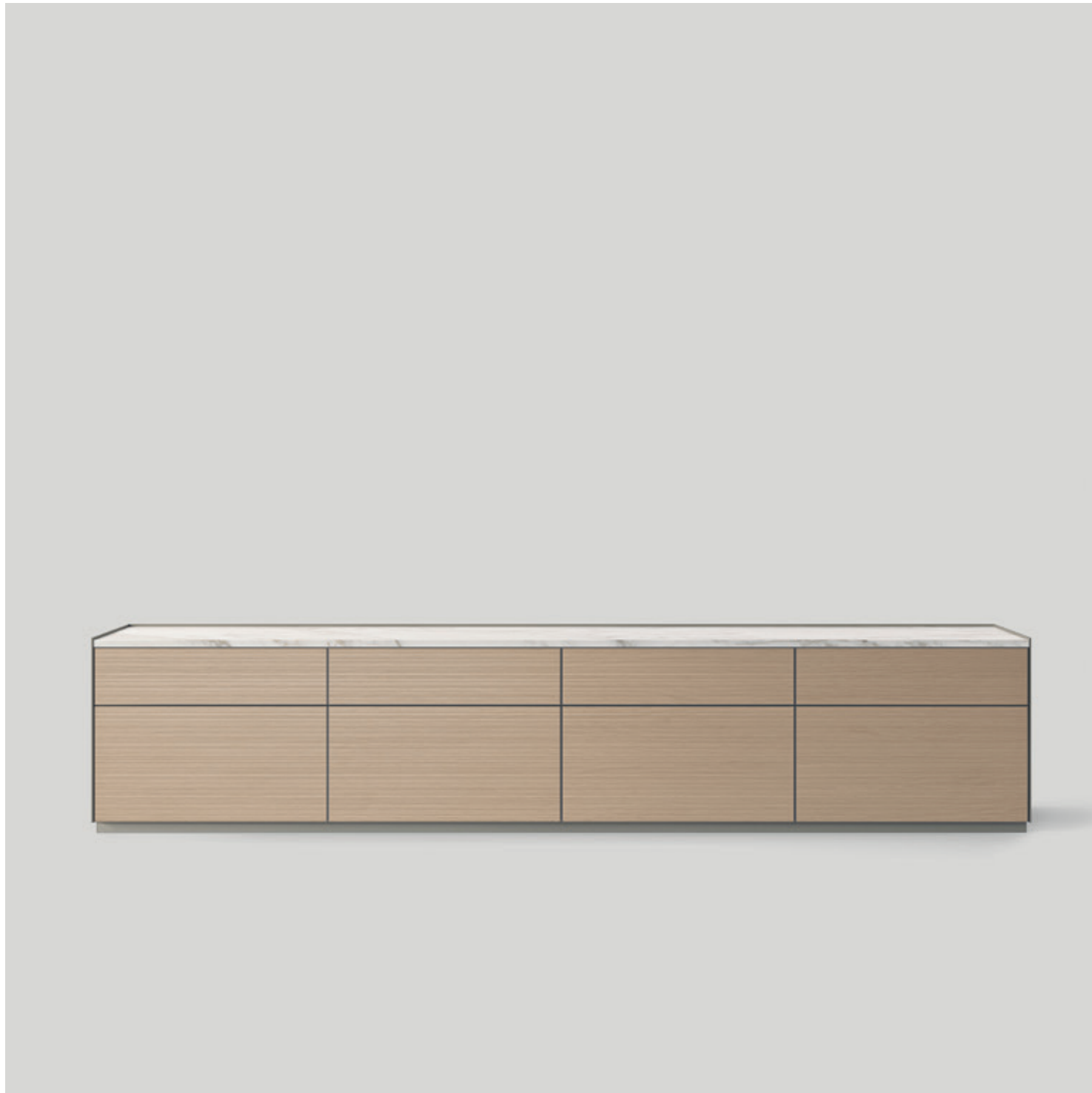

Structure: 304 platino
Fronts: 701 rovere taiga
Marble top: 198 calacatta opaco
W 2570 H 540 D 485

EN The Self Bold marble top is one of the distinctive features of the collection: thanks to its refined materiality it lends elegance and refinement to the product. Available in two thicknesses - 20 or 50 mm - the marble top is available with a glossy or matt effect in all the 9 finishings of the Rimadesio collection.

IT Il top in marmo di Self Bold è uno dei tratti distintivi della collezione: grazie alla sua ricercata matericità conferisce eleganza e raffinatezza al prodotto. Disponibile in due spessori, 20 o 50 mm, il top in marmo è proposto con effetto lucido oppure opaco in tutte le 9 finiture della collezione Rimadesio.

DE Die Marmorplatte von Self Bold ist eines der charakteristischen Merkmale der Kollektion: Ihre erlesene Materialität verleiht dem Produkt Eleganz und Raffinesse. Die Marmorplatte ist in den beiden Stärken 20 und 50 mm erhältlich und wird in allen 9 Oberflächen der Rimadesio-Kollektion in glänzender oder matter Ausführung angeboten.

FR Le plateau en marbre de Self Bold est l'une des caractéristiques distinctives de la collection: grâce au raffinement de sa matière, il confère une élégance sans pareil au produit. Proposé en deux épaisseurs, 20 ou 50 mm, le plateau en marbre est disponible en effet brillant ou mat, dans les 9 finitions de la collection Rimadesio.

ES El tablero de mármol de Self Bold es una de las características distintivas de la colección: gracias a su refinada materialidad confiere elegancia y refinamiento al producto. Disponible en dos espesores, 20 o 50 mm, el tablero de mármol está disponible con efecto brillante o mate en los 9 acabados de la colección Rimadesio.

RU Мраморная столешница Self Bold — одна из отличительных особенностей коллекции: ее изысканный материал придает изделию элегантность и утонченность. Мраморная столешница предлагается в двух вариантах толщины — 20 или 50 мм, с полированной или матовой поверхностью во всех 9 вариантах отделки коллекции Rimadesio.

汉语 Self Bold 的大理石台面为系列的重点特色之一:精美的材质为这项产品增添了典雅与细腻感。大理石台面有 20 毫米和 50 毫米两种厚度,表面处理则有 Rimadesio 系列里共 9 种亮面或哑光效果可供选择。



Structure: 304 platino
Glass: 304 platino lucido
Marble top: 28 calacatta
W 2570 H 565 D 485



Structure: 304 platino
Glass: 304 platino lucido
Marble top: 28 calacatta
W 2570 H 565 D 485

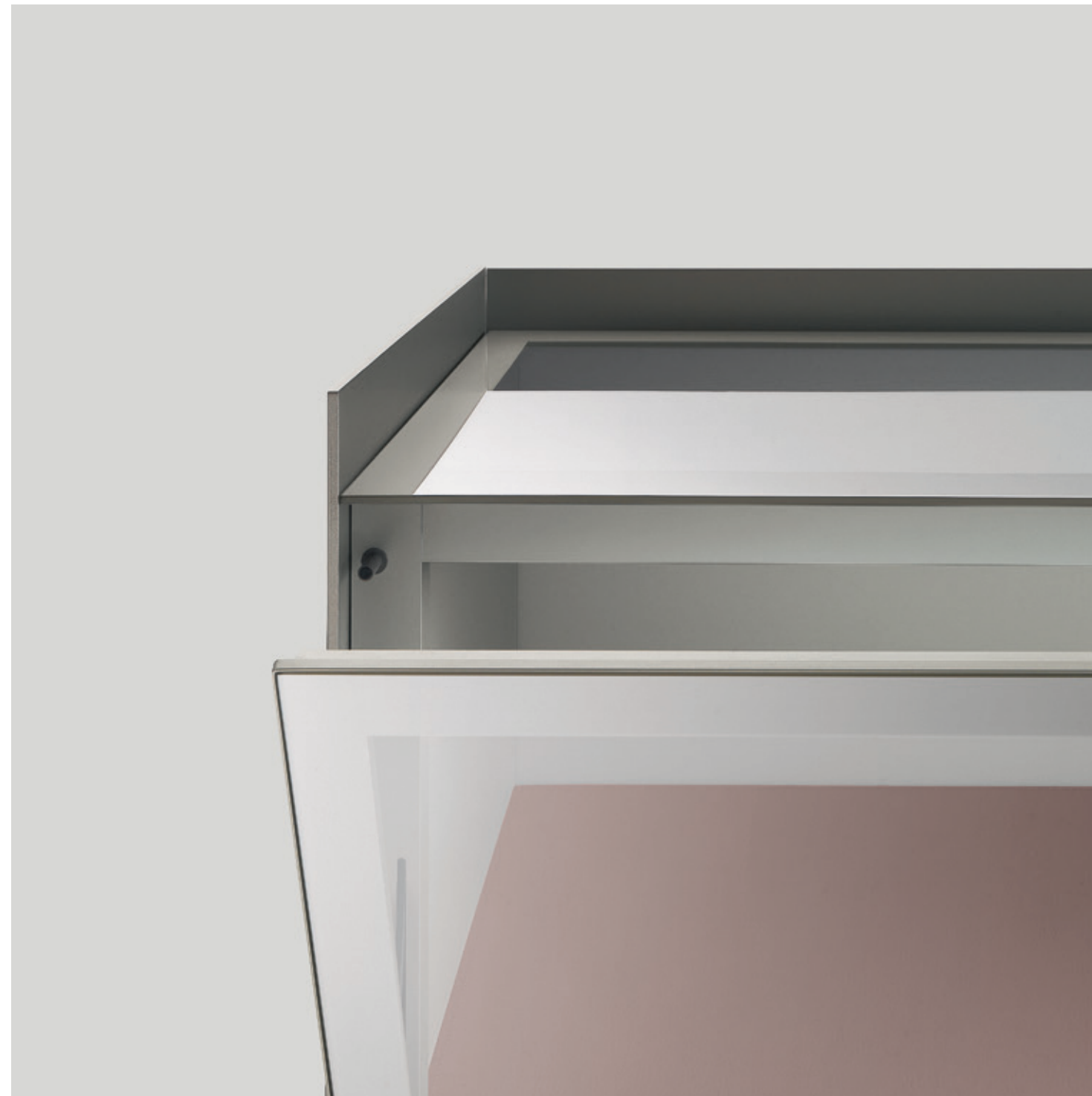

Structure: 304 platino
Glass: 304 platino lucido
Cabinet top and door: 67 riflettente chiaro
Cabinet internal sides and back panel: 137 platino opaco
Cabinet internal top in synthetic leather: 156 rubens
W 1930 H 1045 D 485



Structure: 303 bronzo
Glass: 84 moro lucido
Marble top: 180 emperador
W 2570 H 725 D 485



Structure: 69 palladio
Glass: 45 avorio lucido
Marble top: 28 calacatta
W 1290 H 1365 D 485

Structure: 83 piombo
Glass: 83 piombo lucido
Marble top: 184 crystal grey
W 1930 H 725 D 485



Structure: 304 platino
Fronts: 404 platino diamante
Marble top: 28 calacatta
W 2570 H 186 D 488

In this photo
Sliding doors: Maxi

EN The Self suspended unit is available with a 26 mm side panel and a 20 mm marble top. In the backlit compositions the aluminium frame is also available with a height of 160 mm. Rimadesio's ongoing stylistic research finds expression in the diamante glass, showcased here in a platino finishing. Featuring a finely dotted and back-lacquered embossed surface, it is scratch-resistant and fingerprint refractory.

IT Il contenitore sospeso Self è disponibile con fianco ribassato da 26 mm e top in marmo da 20 mm. Nelle composizioni retroilluminate il telaio in alluminio è disponibile anche con altezza 160 mm. La continua ricerca stilistica di Rimadesio trova espressione nel vetro diamante, qui presentato in finitura platino. Caratterizzato da una superficie in rilievo finemente puntinata e retrolaccata, è resistente ai graffi e refrattario alle impronte digitali.

DE Das Self-Hängeelement ist mit einer abgesenkten Seite von 26 mm und einer 20 mm hohen Marmorplatte erhältlich. In hinterleuchteten Kompositionen ist der Aluminiumrahmen auch mit einer Höhe von 160 mm zu haben. Die fortgesetzte stilistische Entwicklung von Rimadesio findet ihren Ausdruck im Diamante Glas, das hier in einer Platino Ausführung präsentiert wird. Die fein geprägte, rückseitig lackierte Oberfläche ist kratzfest und unempfindlich gegen Fingerabdrücke.

FR Le système de rangement suspendu Self est disponible avec un côté rebassé de 26 mm et un dessus en marbre de 20 mm. Dans les compositions rétroéclairées, le cadre en aluminium est également disponible avec une hauteur de 160 mm. La recherche stylistique Rimadesio atteint son paroxysme avec le verre diamante, présenté ici dans une finition platino. Doté d'une surface en relief finement pointillée et rétro-laquée, il résiste aux rayures et aux traces de doigts.

ES El contenedor suspendido Self está disponible con un lateral rebajado de 26 mm y un tablero de mármol de 20 mm. En las composiciones retroiluminadas también está disponible el marco de aluminio con una altura de 160 mm. La continua investigación estilística de Rimadesio encuentra expresión en el cristal diamante, presentado aquí en un acabado platino. Con una superficie en relieve finamente punteada y lacada en la parte posterior, es resistente a los arañazos y a las huellas dactilares.

RU Навесной шкаф Self предлагается с опущенными на 26 мм боковыми стенками и мраморной столешницей толщиной 20 мм. В композициях с подсветкой высота алюминиевой рамы составляет 160 мм. Непрерывный поиск новых стилистических решений Rimadesio нашел свое выражение в стекле diamante, представленном в этой коллекции в платиновой отделке. Благодаря тонкой рельефной поверхности с лакировкой задней поверхности оно устойчиво к появлению царапин и невосприимчиво к отпечаткам пальцев.

汉语 Self 吊柜有 26 毫米厚的下降侧板以及 20 毫米厚的大理石台面可供选择。在设有后方照明的组合柜中，铝合金框架的高度为 160 毫米。Rimadesio 持续不断的风格研究体现在 Diamante 玻璃上，此处所展示的表面处理为铂金。表面以细腻的点状突起纹理以及背漆工艺尤为特色，抗刮耐，不易沾染指纹。



Structure: 304 platino
Fronts: 404 platino diamante
Marble top: 28 calacatta
W 2570 H 186 D 488



Structure: 83 piombo
Top and door: 67 riflettente chiaro
Glass doors: 83 piombo lucido
Glass shelves: 63 grigio trasparente
Internal back panel: 89 nero reflex
Internal drawer: 19 rovere termotrattato, 154 argilla
Cabinet interior: 19 rovere termotrattato
W 1290 H 1525 D 485



Structure: 300 rame
Glass: 75 amaranto lucido
Cabinet internal top: 133 rame opaco
Cabinet door: 00 trasparente
Cabinet internal sides and back panel: 129 amaranto opaco
W 3210 H 371 D 494

In this photo
Wall panelling system: Modulor
Coffee table: Tray

EN Detail of the Self bold cabinet with flap door: the Rimadesio technology made the gas opening mechanism invisible. An exclusive project allowing cushioned and silent movements. The door is characterized by a continuous perimeter profile, manufactured through an exclusive production technique. The proposal is available in three widths: 960, 1280 and 1920 mm.

IT Particolare della vetrina Self bold con anta ribalta: la tecnologia Rimadesio ha permesso di rendere invisibile il meccanismo di apertura a gas. Un progetto esclusivo che assicura movimenti ammortizzati e silenziosi. L'anta è caratterizzata dal profilo perimetrale continuo, realizzato attraverso una tecnica di produzione esclusiva. La proposta è disponibile in tre larghezze: 960, 1280 e 1920 mm.

DE Detail der Vitrine Self bold mit klapptür: Die Rimadesio-Technologie macht es möglich, den Gas öffnungsmechanismus unsichtbar zu machen. Ein exklusives Projekt, das gedämpfte und stille Bewegungen gewährleistet. Die Tür zeichnet sich durch ein umlaufendes Umfangsprofil aus, das durch eine exklusive Produktionstechnik realisiert wird. Das Modell ist in drei Breiten erhältlich: 960, 1280 und 1920 mm.

FR Détail de la vitrine Self bold avec porte abatante: la technologie Rimadesio a permis de rendre invisible le mécanisme d'ouverture à gaz. Un projet exclusif qui assure des mouvements amortis et silencieux. La porte se caractérise par un profil périmétrique continu, réalisé selon une technique de production exclusive. La proposition est disponible en trois largeurs: 960, 1280 et 1920 mm.

ES Detalle de la vitrina Self bold con puerta abatible: la tecnología Rimadesio ha hecho posible que el mecanismo de apertura de gas sea invisible. Un proyecto exclusivo que garantiza movimientos amortiguados y silenciosos. La puerta se caracteriza por el perfil perimetral continuo, realizado a través de una técnica de producción exclusiva. La propuesta está disponible en tres anchos: 960, 1280 y 1920 mm.

RU Деталь витрины Self bold с откидной дверцей: благодаря технологии Rimadesio механизм открывания стал невидимым. Эксклюзивная конструкция обеспечивает мягкость и бесшумность движений. По периметру двери расположен непрерывный профиль, созданный с использованием эксклюзивной технологии производства. Предложение доступно в трех вариантах ширины: 960, 1280 и 1920 мм.

汉语 Self bold 翻门陈列柜的特色为:通过 Rimadesio 的技术,气动开关装置得以实现隐形化。这项独特的设计确保门扇开关时安静与缓冲体验。这款门扇的特色为采用独特的生产技术制成的连续边缘轮廓。这款设计有三种宽度:960 毫米、1280 毫米和 1920 毫米可供选择。

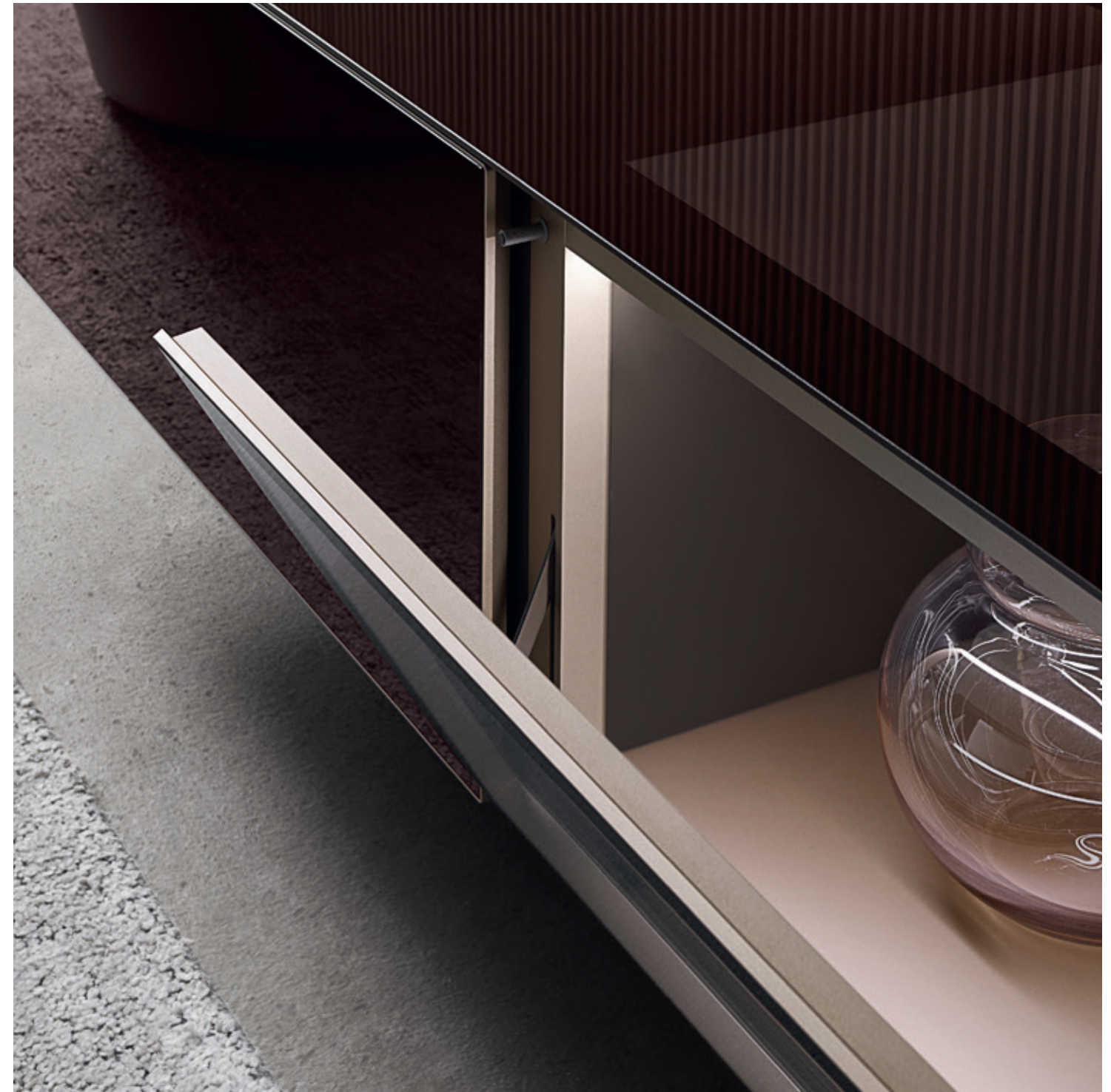

Structure: 300 rame
Glass: 75 amaranto lucido
Cabinet internal top: 133 rame opaco
Cabinet door: 00 trasparente
Cabinet internal sides and back panel: 129 amaranto opaco
W 3210 H 371 D 494

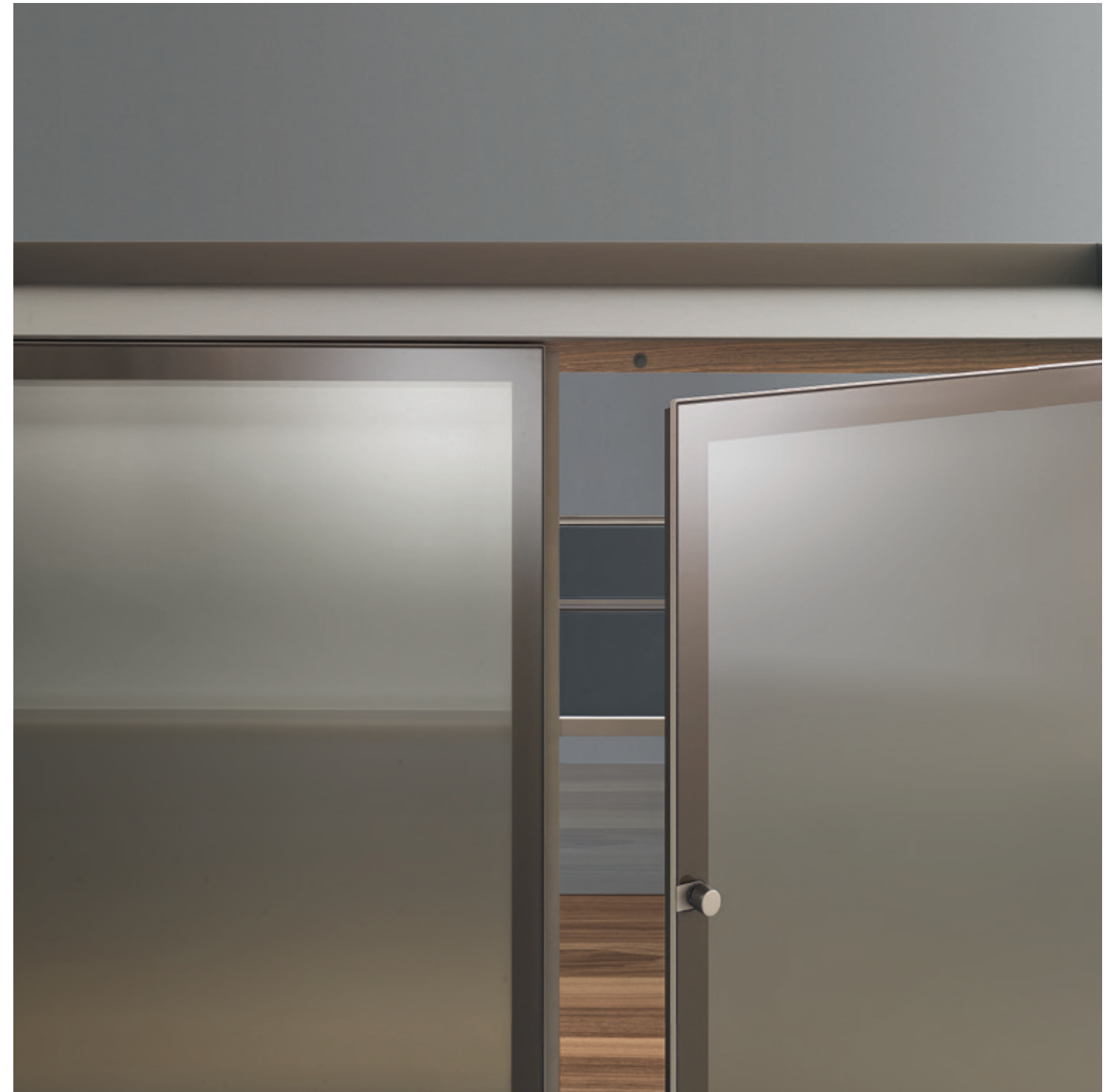

Structure: 303 bronzo
Top: 136 bronzo opaco
Doors: 04 acidato bronzo
Interior and open modules: 15 noce
Internal shelves: 63 grigio trasparente
Internal back panel: 89 nero reflex
W 1290 H 1525 D 485



Structure: 300 rame
Sides and rear profile: 300 rame
Glass top: 133 rame opaco
Cabinet interior: 15 noce
Shelves: 63 grigio trasparente
Internal back panel: 89 nero reflex
W 2570 H 691 D 488

In this photo
Sliding doors: Velaria





Structure: 13 nero
Fronts: 700 tinto ebano taiga
Glass top: 102 nero opaco
W 1290 H 1340 D 485

In this photo
Table: Manta

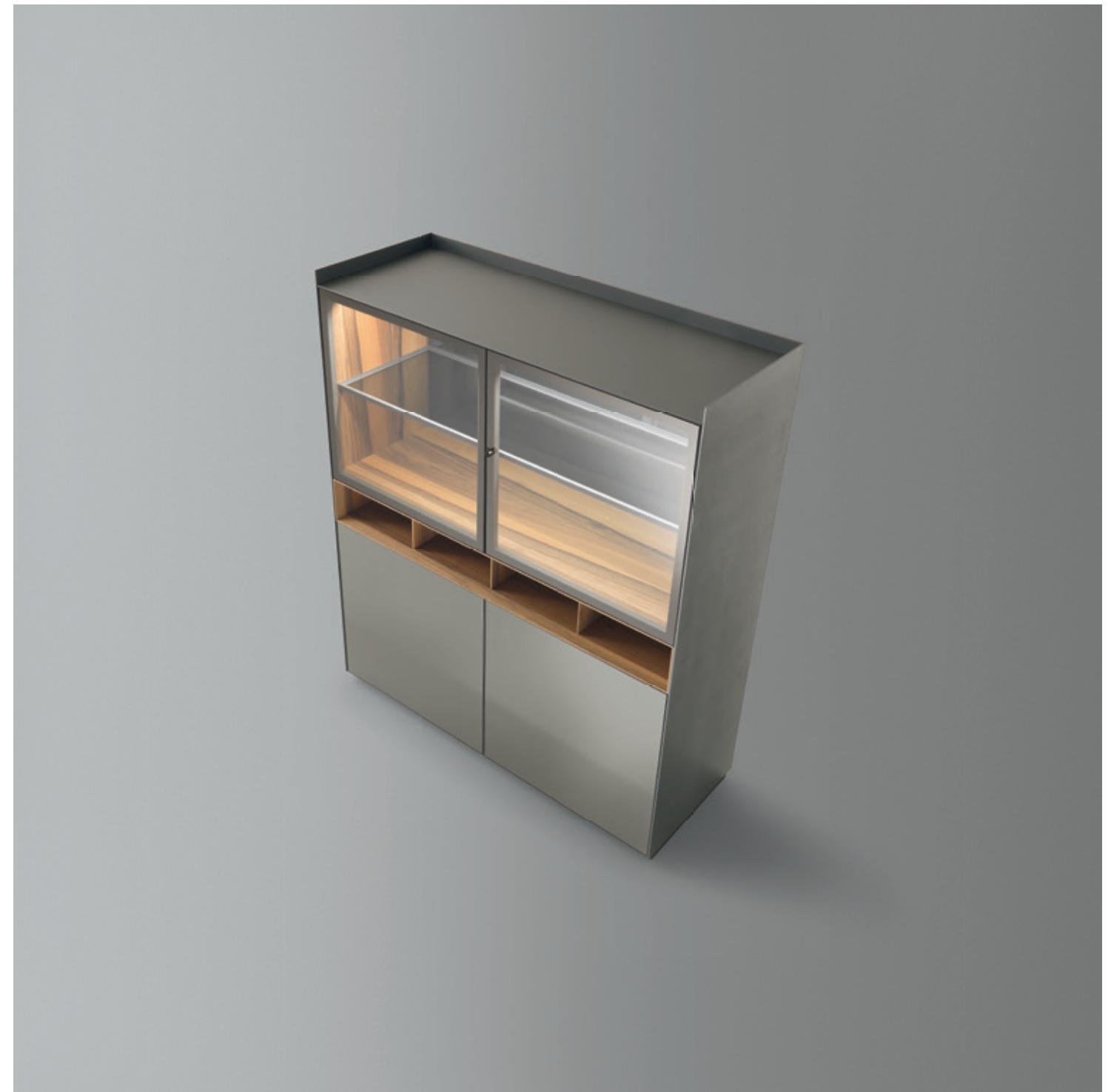

Structure, sides and rear profile: 83 piombo
Glass top: 127 piombo opaco
Glass doors: 67 riflettente chiaro, 83 piombo lucido
Open modules and cabinet interior: 15 noce
Shelf: 63 grigio trasparente
Internal back panel: 89 nero reflex
W 1290 H 1525 D 485



BEDSIDE UNIT
 Structure: 302 grafite
 Glass: 135 grafite opaco
 Fronts: 700 tinto ebano taiga
 W 970 H 380 D 485

SELF BOLD



BEDSIDE UNIT
 Structure: 69 palladio
 Drawer front: 304 platino
 Marble top: 28 calacatta
 W 650 H 405 D 485

DRAWER UNIT
 Structure: 303 bronzo
 Drawer front: 58 caffè lucido
 Marble top: 180 emperador
 W 650 H 1365 D 485

DRAWER UNIT
 Structure: 301 peltro
 Litech fronts and top: G002 moka
 W 1930 H 725 D 485



SECRETAIRE
Structure: 300 rame
Glass: 75 amaranto lucido
Internal structure and drawers: 15 noce
Internal back panel: 68 specchio grigio
Writing desk and drawers interior
in synthetic leather: 153 castoro
W 650 H 1365 D 485

SELF UP: THE FREESTANDING COMPOSITIONS WITH HORIZONTAL AND VERTICAL MODULARITY CHARACTERIZED BY ALUMINIUM FEET IN TWO SIZES. A WIDE VARIETY OF COMPOSITIONAL SOLUTIONS, DEFINED BY AN AESTHETIC INSPIRED BY MAXIMUM FORMAL LIGHTNESS.

IT Self Up: le composizioni freestanding a sviluppo orizzontale e verticale caratterizzate dai piedini in alluminio in due misure. Un'ampia varietà di soluzioni compositive, definite da un'estetica ispirata alla massima leggerezza formale.

DE Self Up: frei stehende Kompositionen in horizontaler und vertikaler Ausrichtung mit Aluminiumfüßen in zwei Größen. Eine große Vielfalt an modularen Lösungen mit einer charakteristischen, von maximaler Leichtigkeit geprägten Ästhetik der Form.

FR Self up: les compositions autoportantes à développement horizontal et vertical, caractérisées par des pieds en aluminium disponibles en deux dimensions. Une grande modularité en termes de compositions, avec une esthétique caractérisée par une grande légèreté de formes.

ES Self up: las composiciones independientes con desarrollo horizontal y vertical caracterizadas por sus patas de aluminio en dos tamaños. Una amplia variedad de soluciones modulares caracterizadas por una estética inspirada en una absoluta ligereza formal.

RU Self up: отдельно стоящие композиции с горизонтальным и вертикальным размещением на алюминиевых ножках двух размеров. Широкое разнообразие композиционных решений, определяемых эстетикой, вдохновленной максимальной легкостью.

汉语 Self up: 水平和垂直发展的独立式组合柜之特色为铝合金支脚, 该支脚有两种尺寸。各式各样的组合方案, 美学灵感源于造型上极度轻盈的感受。



Structure: 303 bronzo
Glass top: 136 bronzo opaco
Fronts: 17 noce sahara
W 2250 H 860 D 485

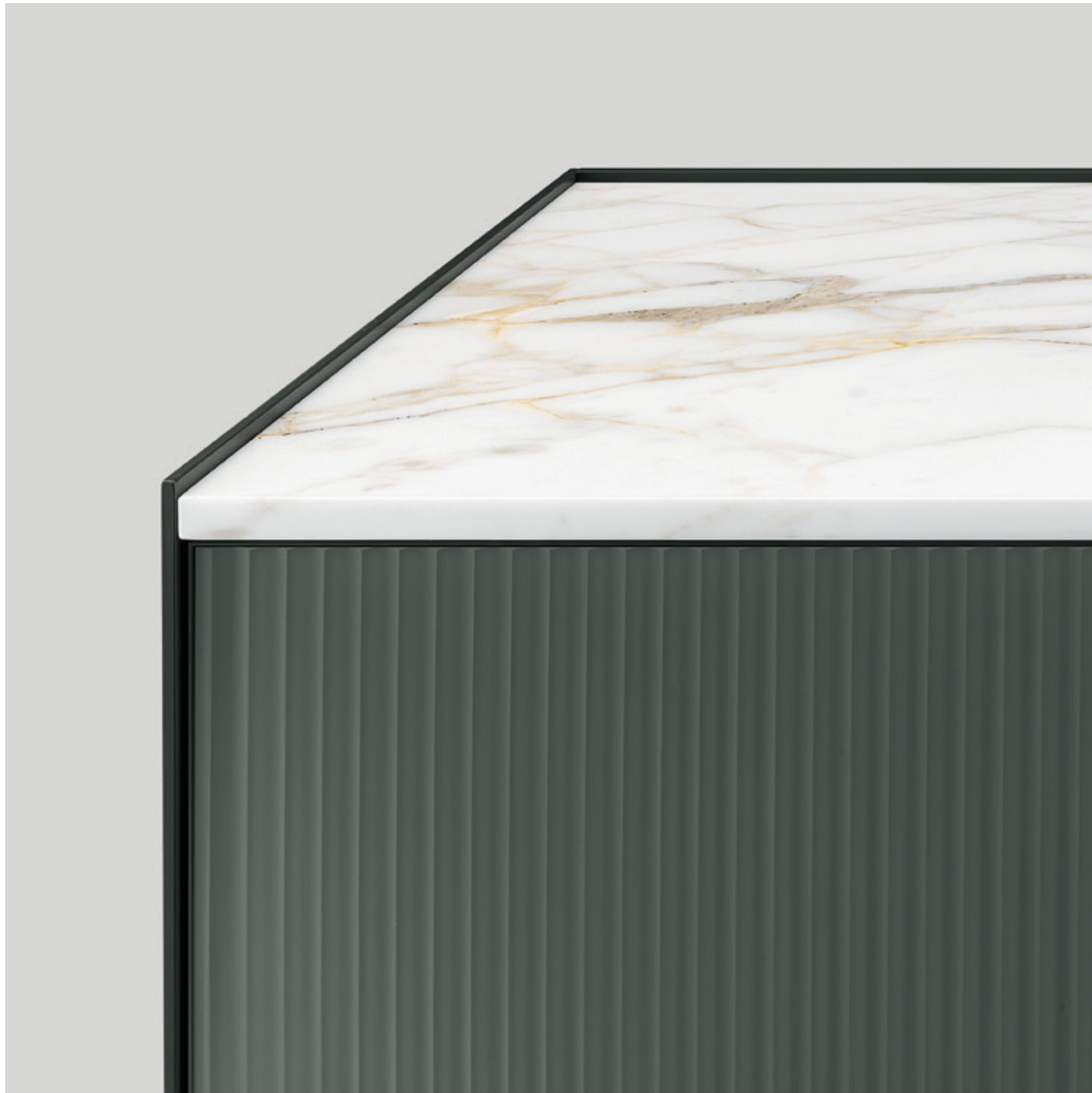

Structure: 314 verde lichene
Glass doors: 514 verde lichene sahara
Marble top: 28 calacatta
W 2570 H 780 D 485

EN A detail that describes the main design features of the Self system, with surfaces entirely made of lacquered glass in the colours of the Ecolorsystem collection. The options available for the containers include hinged doors, flap doors, two-height drawers equipped with push opening and cushioned self-closing.

IT Un dettaglio che descrive le principali caratteristiche progettuali del sistema Self, con le superfici interamente in vetro laccato nei colori della collezione Ecolorsystem. Le possibilità dei contenitori prevedono ante battenti, ante a ribalta, cassetti a due altezze dotati di apertura push e auto-rientro ammortizzato.

DE Ein Detail, das die wichtigsten Gestaltungsmerkmale des Self-Systems charakterisiert, mit Oberflächen, die vollständig aus lackiertem Glas in den Farben der Kollektion Ecolorsystem bestehen. Die Aufbewahrungslösungen sehen Flügeltüren, Klapptüren und Schubladen mit zwei Höhen vor, die sich per Push-to-Open öffnen lassen und über einen sanften Selbsteinzug verfügen.

FR Un détail qui décrit les principales caractéristiques conceptuelles du système Self, avec des surfaces entièrement réalisées en verre laqué, et reprenant les couleurs de la collection Ecolorsystem. Les systèmes de rangement peuvent être dotés de portes battantes, portes abattantes et tiroirs à double hauteur avec ouverture à pression et retour automatique amorti.

ES Un detalle que describe las principales características del diseño del sistema Self, con superficies íntegramente de vidrio lacado en los colores de la colección Ecolorsystem. Las posibilidades de los contenedores incluyen puertas batientes, puertas abatibles, cajones de dos alturas dotados de apertura push y autorretorno amortiguado.

RU Деталь, описывающая основные особенности дизайна системы Self, полностью облицованной крашеным стеклом в цветах коллекции Ecolorsystem. Варианты системы хранения включают в себя распашные дверцы, откидные дверцы, ящики двух вариантов высоты, оснащенные механизмом пуш-пулл с плавным закрыванием с плавным закрытием.

汉语 这项细节描绘出 Self 系统主要的设计特点, 表面皆采用 Ecolorsystem 系列色彩的漆面玻璃打造。储物柜可选铰链门、翻门、带自动软关闭功能和推弹开启系统的高低抽屉。





Structure: 13 nero
Glass top, doors, back panel and sides: 102 nero opaco
Drawer interior in synthetic leather: 159 etna
W 2570 H 759 D 485



Structure: 302 grafite
Wooden doors: 20 rovere termotrattato sahara
Glass top: 135 grafite opaco
W 2570 H 780 D 485

EN Thanks to its infinite modularity, the Self system can be configured by creating vertical or horizontal layouts suitable for different uses. The units can be placed next to each other or overlapped.

IT Grazie alla sua infinita componibilità, il sistema Self può essere configurato creando layout a sviluppo verticale o orizzontale adatti alle diverse destinazioni d'uso. I moduli possono essere accostati tra loro, oppure sovrapposti.

DE Dank seiner unendlichen Kompositionsmöglichkeiten kann das Self-System so konfiguriert werden, dass vertikale oder horizontale Layouts für verschiedene Verwendungszwecke entstehen. Die Module können nebeneinander oder übereinander angeordnet werden.

FR Grâce à sa modularité infinie, le système Self peut être configuré en créant des compositions verticales ou horizontales adaptées aux différents utilisations. Les modules peuvent être juxtaposés ou superposés.

ES Gracias a su infinita modularidad, el sistema Self se puede configurar creando disposiciones verticales u horizontales adecuadas para diferentes usos. Los módulos pueden colocarse uno al lado del otro o superponerse.

RU Благодаря бесконечной модульности система Self может быть сконфигурирована с вертикальным или горизонтальным размещением, подходящим для различных целей. Модули можно располагать рядом друг с другом или ставить друг на друга.

汉语 Self 系统具有模块化的无限组合性, 因此可以根据不同需求来进行纵向或横向配置。模块能以并排或堆叠的方式进行放置。



Structure: 14 brown
Glass top, doors, back panel and sides: 126 palladio opaco
Open modules: 15 noce
W 1290 H 1479 D 485



Structure and open modules: 58 caffè
Glass top, doors, back panel and sides: 98 lino opaco
W 2570 H 839 D 485

SELF UP



Structure: 302 grafite
Glass top, doors, back panel and sides:
88 grigio scuro lucido
W 2570 H 839 D 485

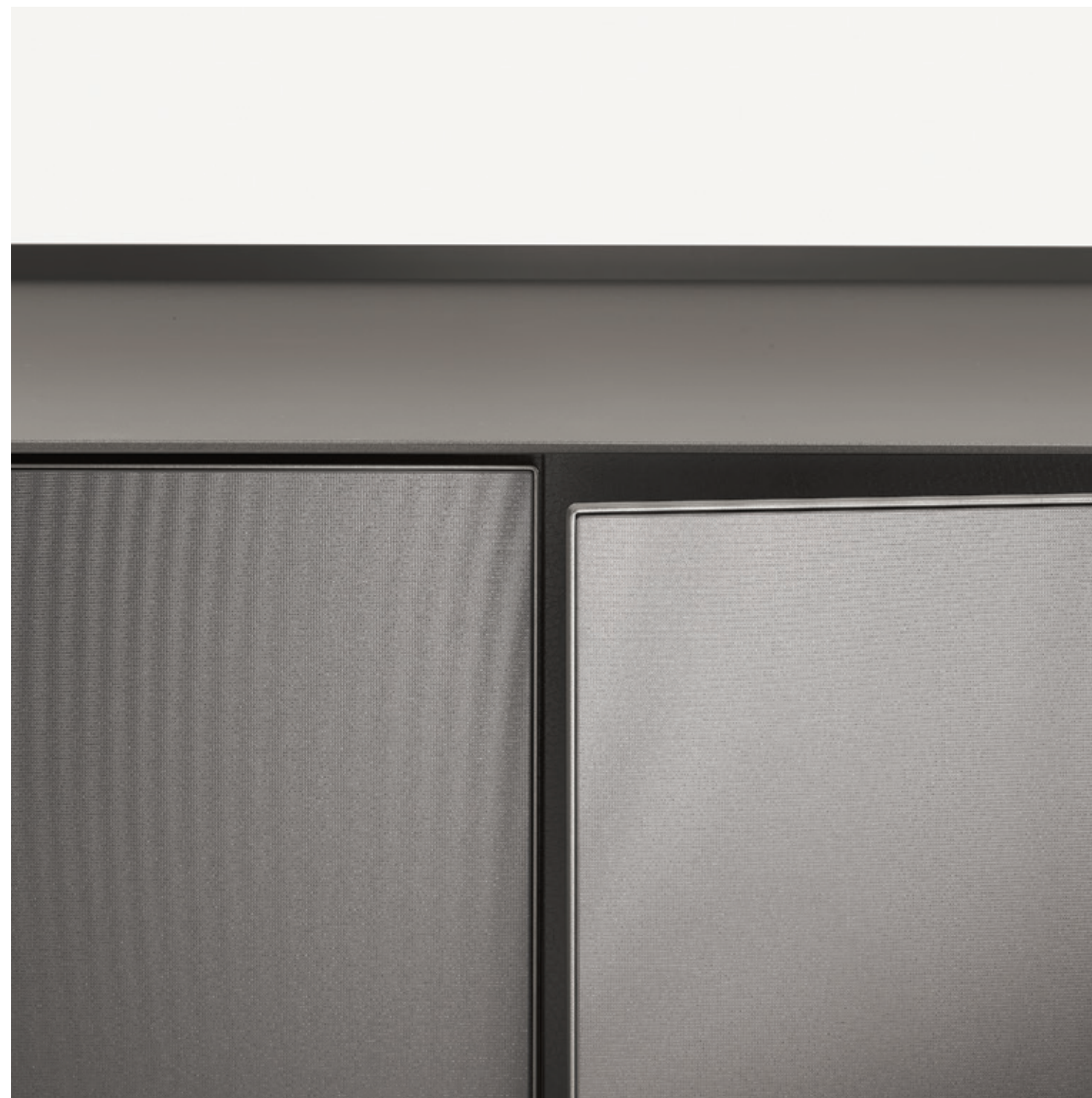

EN Versatility, coherence, absolute perfection in modularity. The Self Up system includes the modular bookcase version with square-shaped modules with vertical and horizontal development.

IT Versatilità, coerenza, perfezione assoluta nella modularità. Il sistema Self Up prevede la versione libreria componibile con moduli di forma quadrata a sviluppo verticale e orizzontale.

DE Vielseitigkeit, Konsistenz, absolute Perfektion der Modularität. Das System Self Up umfasst eine Version als modulares Bücherregal mit quadratischen, vertikal oder horizontal ausgerichteten Modulen.

FR Polyvalence, cohérence, modularité absolue. Le système Self Up comprend une bibliothèque modulaire, avec des modules carrés à développement vertical et horizontal.

ES Versatilidad, coherencia, perfección absoluta en la modularidad. El sistema Self Up incluye una versión de librería modular con módulos de forma cuadrada con desarrollo vertical y horizontal.

RU Универсальность, последовательность, абсолютное совершенство модульности. Система Self Up включает в себя версию книжного шкафа, собираемого с помощью квадратных модулей в горизонтальном и вертикальном направлениях.

汉语 多功能性、一致协调性以及绝对完美的模块化。Self Up 系统包括模块化书柜的版本，由垂直和水平方向发展的方形模块组成。



Structure: 13 nero
Glass top and sides: 102 nero opaco
Internal back panel: 68 specchio grigio
W 1290 H 1479 D 335

EN Made with the exclusive "folding" technology, the open units of the Self system are entirely lacquered in the 46 matt colours of the Ecolorsystem range and in noce and rovere termotrattato finishings. The internal shelves and vertical dividers, only 5 mm thick, are made of laminated plastic, a material that provides maximum strength and durability. Rimadesio has developed an exclusive attachment system that includes all the adjustment possibilities necessary to ensure perfect levelling.

IT Realizzati con l'esclusiva tecnologia di piegatura "folding", i vani a giorno del sistema Self sono interamente laccati nei 46 colori opachi del sistema Ecolorsystem e nelle essenze noce e rovere termotrattato. I ripiani interni e i divisori verticali, di soli 5 mm di spessore, sono realizzati in laminato plastico stratificato, un materiale che garantisce la massima solidità e resistenza. Per i vani a giorno appesi a parete, Rimadesio ha sviluppato un esclusivo sistema di aggancio che prevede tutte le possibilità di regolazione necessarie per assicurare una perfetta messa in bolla.

DE Die offenen Fächer des Self-Systems werden mit der exklusiven "folding"-Technologie gefertigt und komplett lackiert – in den 46 matten Farben von Ecolorsystem sowie in Noce und Rovere termotrattato. Die 5 mm starken Innenboeden und die senkrechten Unterteilungen sind aus kunststoff-beschichtetem Laminat. Ein sehr hartes und belastbares Material. Fuer die aufgehängten offenen Faechern hat Rimadesio einen exklusiven Befestigungsbeschlag entwickelt. Dieser Beschlag erlaubt die notige Regulierung fuer eine waagerechte Installation.

FR Réalisés avec la technologie de pliage exclusive "folding", les compartiments ouverts du système Self sont entièrement laqués dans les 46 couleurs mates du système Ecolorsystem et proposés également dans les bois noce et rovere termotrattato. Les étagères internes et les diviseurs verticaux de seulement 5 mm d'épaisseur, sont réalisés en stratifié, un matériau qui garantit solidité et résistance maximale. Pour les modules ouverts suspendus, Rimadesio a développé un exclusif système de fixation, qui comprend tous les équipements nécessaires pour assurer une parfaite régulation.

ES Realizados con la exclusiva tecnología de plegado "folding", los compartimentos abiertos del sistema Self están completamente lacados en los 46 colores mate del sistema Ecolorsystem y en madera de noce y rovere termotrattato. Los estantes internos y los separadores verticales, de sólo 5 mm de grosor, son realizados en plástico laminado, un material que garantiza la máxima solidez y resistencia. Para los módulos colgantes a la pared, Rimadesio ha desarrollado un sistema de sujeción exclusivo, que ofrece todas las instalaciones de regulación necesarias para garantizar la nivelación perfecta.

RU Изготовленные по эксклюзивной технологии сгибания и без кавычек, открытые отделения системы Self полностью покрыты лаком в 46 матовых цветах Ecolorsystem, или отделаны шпоном ореха и термообработанного дуба. Внутренние полки и вертикальные разделители толщиной всего 5 мм изготовлены из многослойного пластикового ламината – материала, гарантирующего максимальную прочность и устойчивость. Для навесных открытых шкафов компания Rimadesio разработала эксклюзивную систему соединений, которая предоставляет все необходимые возможности регулировки для достижения идеального выравнивания.

汉语 Self 系统的开放式收纳格采用独特的“折弯”技术打造，并且以 Ecolorsystem 系统中 46 种哑光漆以及胡桃木和热处理橡木漆进行表面处理。仅 5 毫米厚的内部层板和垂直隔板由分层塑料层压板制成，该材质能确保最高使用强度和经久耐用性。针对壁挂式收纳格，Rimadesio 开发了一套独特的固定系统，并提供任何可能必要的调节，用于确保收纳格之间保持水平一致。



Structure: 13 nero
Glass: 102 nero opaco
Internal back panel: 68 specchio grigio
W 1290 H 1479 D 335



SECRETARE
 Structure: 14 brown
 Glass top, front and sides: 99 caffè opaco
 Wooden internal structure and drawers:
 19 rovere termotrattato
 Writing desk and drawers interior
 in synthetic leather: 153 castoro
 Internal back panel: 68 specchio grigio
 W 650 H 1319 D 485

SELF UP



DRAWER UNIT
 Structure: 30 alluminio
 Glass: 98 lino opaco
 W 650 H 1319 D 485

SECRETARE
 Structure: 14 brown
 Glass: 99 caffè opaco
 W 650 H 1319 D 485

BEDSIDE UNIT
 Structure: 33 verde oliva
 Glass: 111 verde oliva opaco
 W 650 H 359 D 4485

EN The Self collection includes the customizable secretaire available in the three variants "Self, Self up and Self bold." The system is provided with internal LED lighting with a light sensor.

IT La collezione Self prevede il secretaire personalizzabile disponibile nelle tre varianti "Self, Self up e Self bold". Il sistema è dotato di un'illuminazione interna a led con sensore di accensione.

DE Zur Self-Kollektion gehört der individuell gestaltbare Sekretär, der in drei Varianten "Self, Self up und Self bold"- erhältlich ist. Das System umfasst eine Innenbeleuchtung mit LEDs und Einschaltensor.

FR La collection Self comprend un secrétaire personnalisable, disponible en trois variantes "Self, Self up et Self bold". Ce système comprend un éclairage LED interne avec capteur d'allumage.

ES La colección Self incluye un secreter personalizable, disponible en tres variantes "Self, Self up y Self bold". El sistema incluye iluminación LED interna con sensor de encendido.

RU Коллекция Self включает в себя персонализируемый секретер, доступный в трех вариантах: "Self", "Self up" и "Self bold". Система оснащена внутренней светодиодной подсветкой с датчиком включения.

汉语 Self系列的可定制化书桌有Self、Self up、Self bold三种不同的类型，内部装有带光传感器的LED。



SECRETAIRE
Structure: 14 brown
Glass top, front and side: 99 caffè opaco
Wooden internal structure and drawers:
19 rovere termotrattato
Writing desk and drawers interior
in synthetic leather: 153 castoro
Internal back panel: 68 specchio grigio
W 650 H 1319 D 485

Finishing back panel for double-sided version

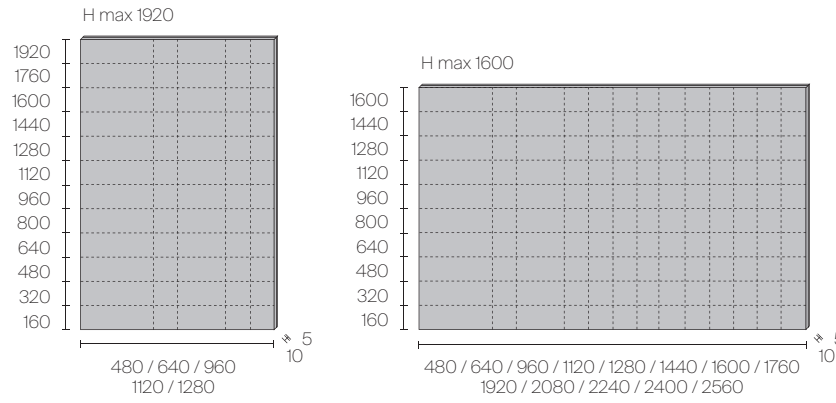

Frame for backlit suspended cabinets with lighting system and additional crosspiece for brackets for stacked suspended units

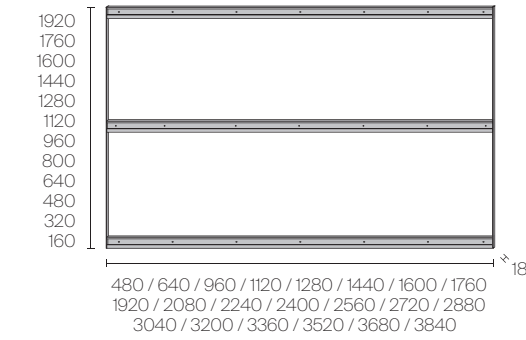

Aluminum skirting

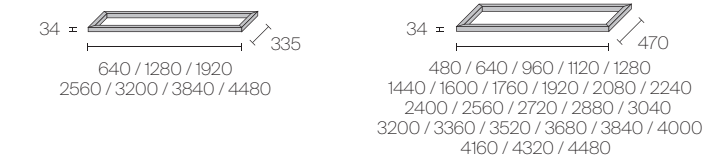

Base with feet

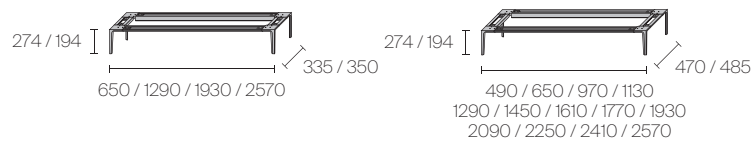

Glass top

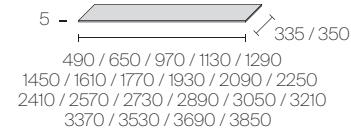

Glass or Litech top

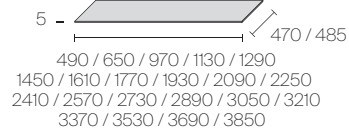

Self bold marble finishing top thickness 51 mm

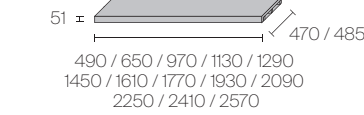

Self bold marble finishing top thickness 20 mm



Lacquered glass and Litech cable duct on top

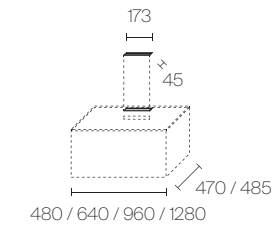

Self bold aluminium finishing side

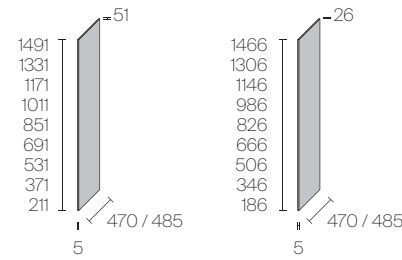

Self/Self up glass finishing side

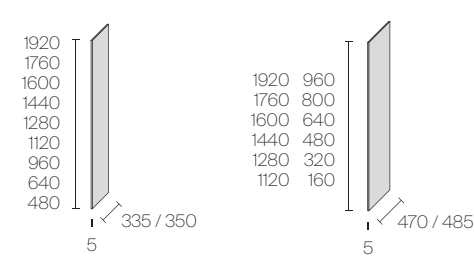

Rear profile of the top available for Self bold

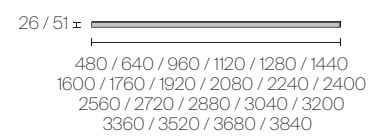

Lower or upper single led lighting

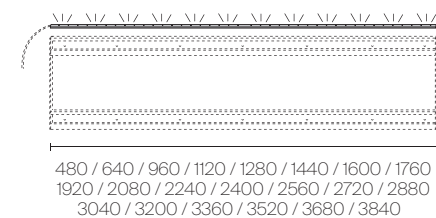

Lower and upper double led lighting

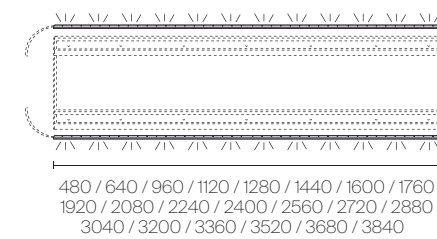

Units with push drawer D 470

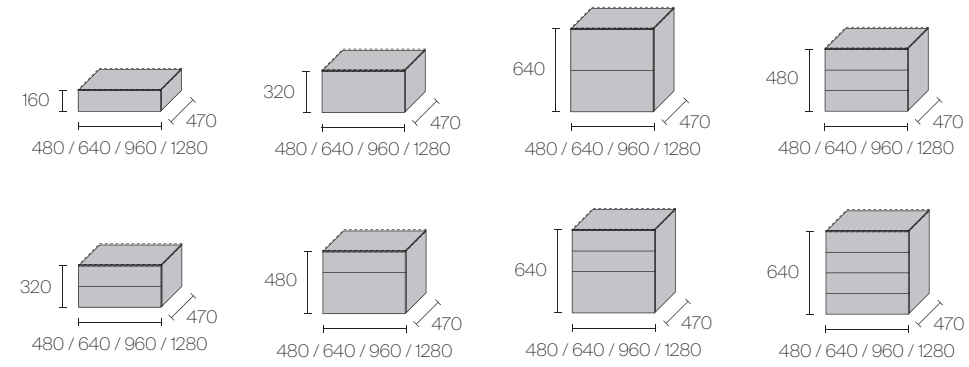

Synthetic leather mat for internal lining

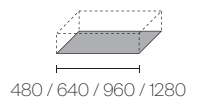

Flap door units D 470

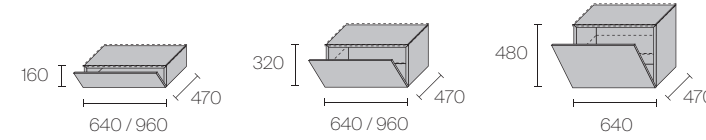

Optional glass shelf for flap door units

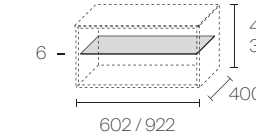

Optional internal back panel for flap door units

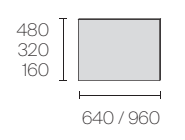

Hinged door units

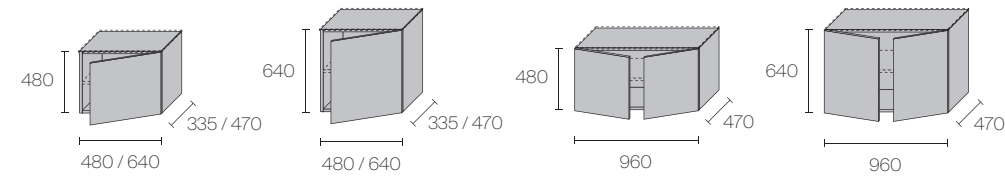

Optional internal back panel for hinged door units

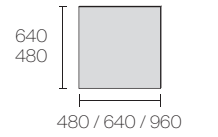

Wooden internal drawer

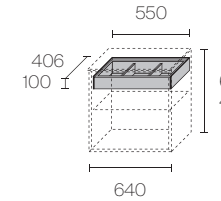

Optional internal glass shelf with aluminium perimeter profile

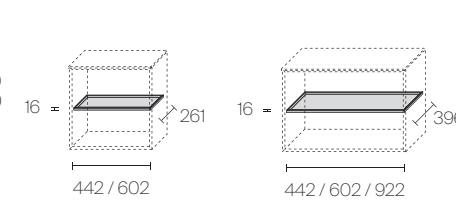

Battery led spotlight for units with hinged and flap doors

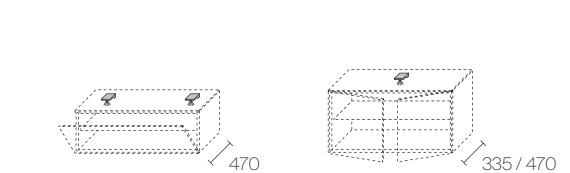

Wooden open modules

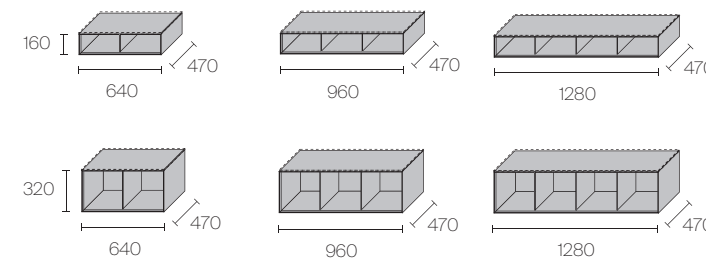

Technical open module. (Optional glass shelf for module H 320)

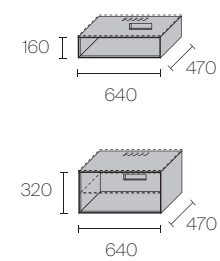

Wooden open modules with optional grey mirror back panel

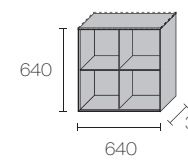

Optional finishing bottom carter

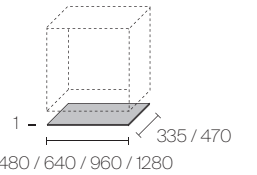



1

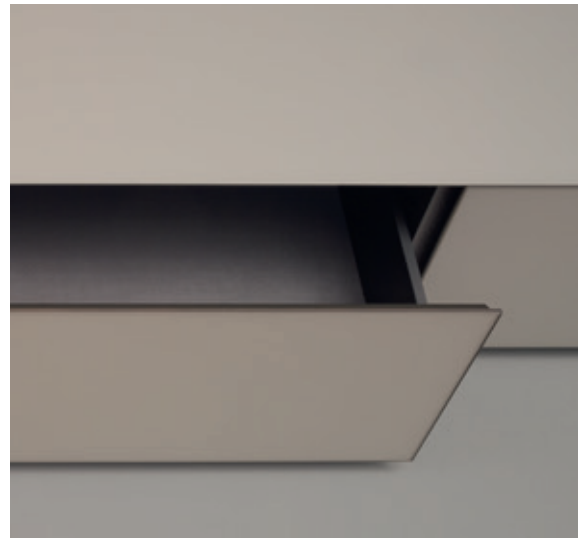

2

1. Push drawer in light grey metal, totally extractable runner and soft close mechanism. Drawer interior in UB07 cuoio grigio melamine finishing
2. Push drawer in dark grey metal, totally extractable runner and soft close mechanism. Drawer interior in UB09 cuoio brown melamine finishing
3. Cabinet with aluminium flap door, internal finishing grey leather melamine, shelf in lacquered glass in the same colour of the supporting structure. Aluminium skirting.
4. Cabinet with brown aluminium flap door, internal finishing brown leather melamine, shelf in lacquered glass in the same colour of the supporting structure. Brown aluminium skirting.



3



4



1



2

1. Push drawer in light grey metal, totally extractable runner and soft close mechanism. Drawer interior in UB07 cuoio grigio melamine finishing
2. Push drawer in dark grey metal, totally extractable runner and soft close mechanism. Drawer interior in UB09 cuoio brown melamine finishing



The internal structure of the drawers and the writing desk are covered with synthetic leather (1). The secretaire has the upper compartment in 15 noce (2) or 19 rovere termotrattato (3) and back panel in 68 specchio grigio.

Self

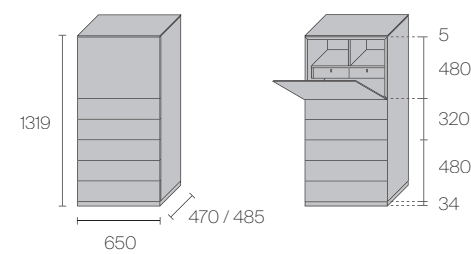

Self bold

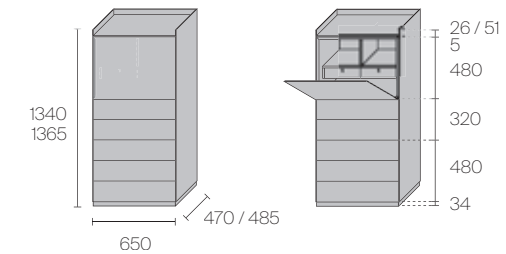

Self up

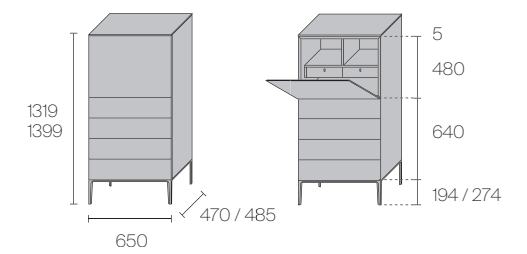

Glossy glass



Matt glass



Satinated glass



Transparent glass



Sahara glass



Taiga glass



Sahara wood

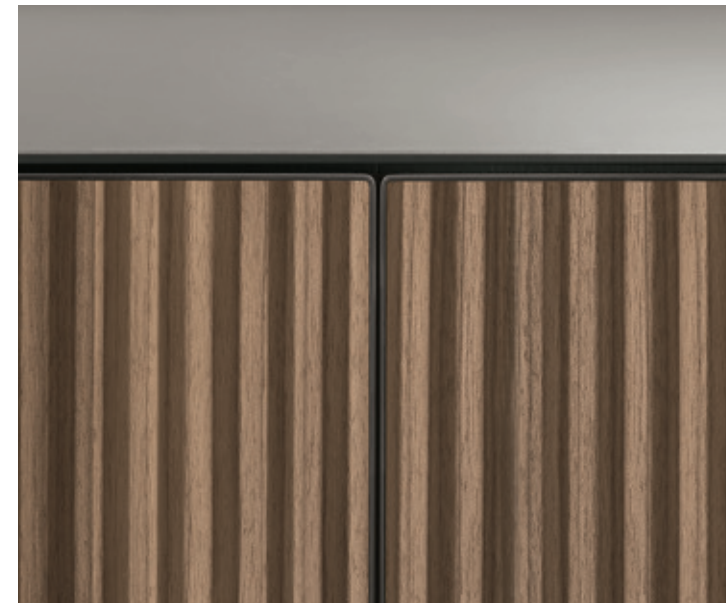

Taiga wood



Diamante glass



Litech



Glass side. Lacquered glass top



Bold side 26. Lacquered glass top



Bold side 51. Lacquered glass top



Glass side. Transparent glass top



Bold side 26. Transparent glass top



Bold side 51. Transparent glass top



Bold side 26. Marble top thickness 20 mm



Bold side 51. Marble top thickness 50 mm



Skirting H 34 mm

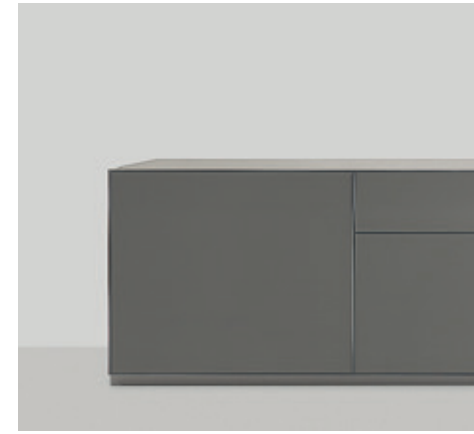

Supporting base with feet H 194 mm



Supporting base with feet H 274 mm



Suspended composition

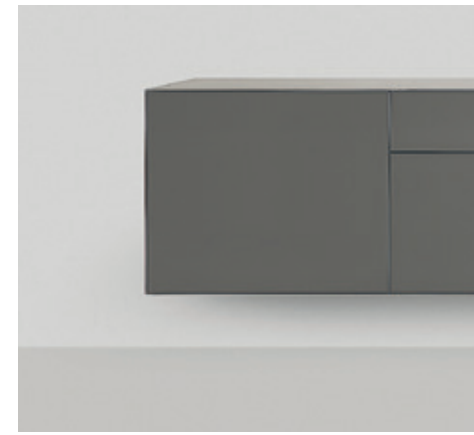

Suspended composition with back led lighting



TECHNICAL DESCRIPTION

EN The Self system offers a wide variety of solutions ensuring maximum aesthetics and functionality. Freestanding compositions are available with an aluminium skirting or feet in two heights. The wall mounting profile allows to create suspended compositions and includes a led lighting system. The drawers, hinged and flap doors are equipped with push opening.

IT Il sistema Self offre un'ampia varietà di soluzioni, che assicurano massima estetica e funzionalità. Le composizioni freestanding sono disponibili con zoccolo in alluminio o piedini in due altezze. Il profilo di aggancio a parete permette di creare composizioni sospese e prevede un sistema di illuminazione led. I cassetti, le ante battenti e a ribalta sono dotate di apertura push.

DE Das Self-System bietet eine Vielzahl von Lösungen, die maximale Ästhetik und Funktionalität gewährleisten. Die Kompositionen von Freestanding sind mit Aluminiumsockel oder Füßen in zwei Höhen erhältlich. Mit dem Wandbefestigungsprofil können Sie Hänge Kompositionen erstellen und ein LED-Beleuchtungssystem bereitstellen. Die Schubladen, Flügel- und Klapptüren sind mit einer Tip-on-Einheit (Push-to-Open) ausgestattet.

FR Le système Self offre une large variété de solutions qui assurent un maximum d'esthétique et fonctionnalité. Les compositions freestanding sont disponibles avec sabot en aluminium ou pieds en deux hauteurs. Le profil d'accroche au mur permet de créer des compositions suspendues et prévoit un système d'éclairage led. Les tiroirs, les portes battantes et abatantes sont équipés d'un système d'ouverture à pression.

ES El sistema Self ofrece una amplia variedad de soluciones, garantizando la máxima estética y funcionalidad. Las composiciones freestanding están disponibles con zócalo de aluminio o patas en dos alturas. El perfil de enganche a la pared permite de crear composiciones colgantes e incluye un sistema de iluminación led. Los cajones y las puertas batientes y abatibles están equipados con apertura push.

RU Система Self предлагает широкий спектр решений, которые обеспечивают полную функциональность и высочайшее эстетическое качество. Отдельностоящий в данном контексте пишется слитно композиции предлагаются с алюминиевым цоколем или ножками в двух вариантах высоты. Настенный крепежный профиль позволяет создавать навесные композиции и включает в себя систему светодиодной подсветки. Выдвижные ящики, распашные и откидные дверцы оснащены функцией открывания нажатием.

汉语 Self 系统提供各式解决方案, 确保最大程度美观和功能性。独立式组合柜有两种高度可供选择, 并可搭配铝合金柱脚或支脚。壁挂式组合柜通过墙面的层板卡槽固定, 其配有 LED 照明系统。抽屉、铰链门和翻门均配有推弹开启系统。



A SYSTEM WHOSE MAIN QUALITY IS COMPOSITIONAL FREEDOM: SELF PLAN IS AVAILABLE IN COMPOSITIONS SUSPENDED ON THE WALL OR INTEGRATED INTO THE MODULOR BOISERIE. DEPENDING ON THE FUNCTIONALITY REQUIRED, IT OFFERS VARIOUS EQUIPPED SOLUTIONS RANGING FROM THE DESK ELEMENT TO THE LIVING ROOM VERSION WITH DRAWERS, FLAP DOORS, OPEN UNITS AND CABLE DUCTS. ENTIRELY MADE OF ALUMINIUM AND PERFECT FOR ANY AREA OF THE HOUSE, SELF PLAN CAN BE CUSTOMISED IN TERMS OF SIZE AND FINISHING.

IT Un sistema che fa della libertà compositiva la sua qualità principale: Self plan si declina in composizioni sospese a parete o integrabili nella boiserie Modulor. A seconda della funzionalità richiesta, offre diverse soluzioni attrezzate che spaziano dall'elemento scrittoio al mobile living con cassetti, ante a ribalta, vani a giorno e passacavi. Realizzato interamente in alluminio e perfetto per arredare ogni zona della casa, Self plan è personalizzabile in dimensioni e finiture.

DE Ein System, bei dem die kompositorische Freiheit im Vordergrund steht: Self Plan ist in wandhängenden Kombinationen erhältlich oder kann in die Modulor-Vertäfelung integriert werden. Je nach gewünschter Funktionalität bietet es verschiedene Ausstattungslösungen, die von Büro- bis zu Mobile-Living-Versionen reichen, mit Schubladen, Klapptüren, offenen Fächern und Kabeldurchgängen. Self Plan ist vollständig aus Aluminium gefertigt und eignet sich perfekt für die Einrichtung aller Bereiche Ihres Zuhauses. Größe und Oberflächen können individuell angepasst werden.

FR Un système qui fait de la modularité sa principale qualité: Self plan se décline en compositions murales suspendues ou intégrées aux boiseries Modulor. Selon les fonctionnalités recherchées, il propose différents équipements, du bureau au meuble de séjour avec tiroirs, portes abattantes, compartiments ouverts et passe-câbles. Entièrement fabriqué en aluminium, idéal pour meubler n'importe quelle pièce de la maison, Self plan peut être personnalisé en termes de dimensions et de finitions.

ES Un sistema que hace de la libertad compositiva su principal cualidad: Self plan está disponible en composiciones suspendidas en la pared o integradas en el revestimiento Modulor. Dependiendo de la funcionalidad requerida, ofrece distintas soluciones de equipamiento que van desde el elemento de escritorio hasta el mueble de salón con cajones, puertas abatibles, compartimentos abiertos y pasa cables. Fabricado íntegramente en aluminio y perfecto para amueblar cualquier zona de la casa, Self plan se puede personalizar en tamaño y acabados.

RU Система, главное качество которой – свобода композиции: Self plan предлагается в навесных композициях или может быть интегрирована в буазери Modulor. В зависимости от требуемой функциональности она предлагает различные варианты комплектации – от добавить «стола» до мебели для гостиной с выдвижными ящиками, откидными дверцами, открытыми отделениями и Кабель-каналом. Изготовленная полностью из алюминия, она идеально подходит для меблировки любой зоны дома, а размер и отделка Self plan могут быть выполнены по индивидуальному заказу.

汉语 这套系统的主要特点为自由组合性: Self plan 有壁挂式组合柜以及能与 Modulor 系统相结合的款式。根据所需的功能, Self plan 提供不同配备的解决方案: 从书桌部件到设有抽屉、翻门、开放式收纳格以及桌面穿线盒等客厅类家具。Self plan 完全以铝合金材质完成, 为打造各种家居空间的完美之选, 其尺寸和表面处理皆可个性化定制。





EN The Self Plan composition lightly scans the wall thanks to the linear surfaces and reduced aluminium thicknesses. The tempered glass top and back panel are assembled to the structure by interlocking without the use of glue. Customisable in terms of size and finishing, Self Plan is available with container units featuring flap doors, drawers, open modules, cable ducts and concealed electrical socket.

IT La composizione Self Plan scandisce la parete con leggerezza grazie alle superfici lineari e agli spessori ridotti in alluminio. Il top e lo schienale in vetro temperato sono assemblati alla struttura tramite incastro senza l'utilizzo di collante. Personalizzabile in dimensioni e finiture, Self Plan è disponibile con moduli contenitore con ante a ribalta, cassetti, vani a giorno, passacavi e presa elettrica a scomparsa.

DE Mit den linearen Oberflächen und der reduzierten Stärke des Aluminiums bietet die Self-Plan-Komposition eine luftige Untergliederung der Wände. Die Platte und die Rückwand aus gehärtetem Glas werden ohne Klebstoff eingepasst. Self Plan kann in Größe und Ausführung individuell angepasst werden und ist mit Aufbewahrungsmodulen mit Klapptüren, Schubladen, offenen Fächern, Kabeldurchführungen und verdeckten Steckdosen erhältlich.

FR La composition Self Plan habille le mur avec légèreté grâce aux surfaces linéaires et aux fines épaisseurs d'aluminium. Le plateau et le fond en verre trempé sont assemblés à la structure par emboîtement, sans utiliser de colle. Avec ses dimensions et ses finitions personnalisables, Self Plan est disponible avec des modules de rangement dotés de portes abattantes, tiroirs, compartiments ouverts, passe-câbles et prises électriques encastrées.

ES La composición Self Plan resalta la pared con ligereza gracias a las superficies lineales y los espesores reducidos del aluminio. El tablero y el fondo de vidrio templado se ensamblan a la estructura mediante encastrado sin el uso de colas. Personalizable en dimensiones y acabados, Self Plan está disponible con módulos contenedores con puertas abatibles, cajones, compartimentos abiertos, pasa cables y toma de corriente oculta.

RU Композиция Self Plan придает стене легкость благодаря линейным поверхностям и уменьшенной толщине алюминия. Столешница и задняя панель из закаленного стекла собираются в конструкцию путем сцепления без использования клея. Система Self Plan предлагается с модулями хранения с откидными дверцами, ящиками, открытыми отделениями, кабель-каналом и скрытыми электрическими розетками.

汉语 线性的表面和轻薄的铝板，Self Plan 的组合性赋予墙面更为轻盈的感受。钢化玻璃打造的台面和背板通过联锁系统装在结构上，无需使用胶水。Self Plan 的尺寸和表面处理皆可个性化定制，有带翻门、抽屉、开放式收纳格、桌面集线盒以及隐藏式电源插座等模块收纳部件可供选择。















SELF PLAN
 Structure: 303 bronzo
 Top, back panel and drawer
 in synthetic leather: 154 argilla
 Open module: 19 rovere termotrattato
 W 2246 H 216 D 525

SELF BOLD
 Structure: 303 bronzo
 Glass: 141 pepe opaco

In this photo
 Wall panelling system: Modulor
 Sliding door: Velaria

EN With its structure made entirely of aluminium, the Self Plan system is based on horizontal modularity, with a fixed depth of 525 mm and a variable length from 1616 to 3856 mm. It has a wide range of finishings. In the desk version, the top and the back panel can be made of glass or synthetic leather. The range is completed by optional upper LED lighting.

IT Il sistema Self Plan, con struttura realizzata interamente in alluminio, è basato su una modularità orizzontale, con profondità fissa di 525 mm e una lunghezza variabile da 1616 a 3856 mm. Presenta un'ampia varietà di finiture. Nella versione scrittoio, il piano e l'alzata posteriore possono essere realizzati in vetro o similpelle. Completa la proposta un'illuminazione led superiore opzionale.

DE Das Self-Plan-System basiert mit seinen vollständig aus Aluminium gefertigten Strukturen auf einer horizontal ausgerichteten Modularität, mit einer festen Tiefe von 525 mm und einer variablen Länge von 1616 bis 3856 mm. Dazu kommt eine große Oberflächenvielfalt. Bei der Schreibtischversion können die Platte und die hintere Setzstufe aus Glas oder Kunstleder gefertigt werden. Die optionale LED-Beleuchtung an der Oberseite vervollständigt das Angebot.

FR Entièrement réalisé en aluminium, Self plan affiche une modularité horizontale, avec une profondeur fixe de 525 mm et une longueur comprise entre 1616 et 3856 mm et le tout proposé dans une large variété de finitions. Dans sa version bureau, le plateau et le fond peuvent être réalisés en verre ou similicuir. L'offre est complétée par un éclairage LED supérieur en option.

ES El sistema Self plan, con estructura realizada íntegramente en aluminio, se basa en una modularidad horizontal, con una profundidad fija de 525 mm y una longitud variable de 1616 a 3856 mm. Presenta una gran variedad de acabados. En la versión de escritorio, el plano horizontal y la parte posterior pueden realizarse en cristal o simil cuero. La propuesta se completa con una iluminación LED superior opcional.

RU Система Self Plan со структурой, полностью выполненной из алюминия, основана на горизонтальной модульности, с фиксированной глубиной 525 мм и изменяемой длиной от 1616 до 3856 мм. Она отличается широким разнообразием отделки. У письменного стола столешница и задняя стойка могут быть выполнены из стекла или эко-кожи. Дополнительное верхнее светодиодное освещение завершает композицию.

汉语 Self Plan 系统的结构完全由铝合金打造,以横向发展的模块化为基底,规格为 525 毫米的固定深度以及 1616 毫米到 3856 毫米不等的长度,有多种表面处理可供选择。在办公桌的版本中,台面和后方背板可采用玻璃打造或以仿真皮革包覆。上部的 LED 照明更加完善了这项设计提案。



SELF PLAN
Structure: 303 bronzo
Top, back panel and drawer
in synthetic leather: 154 argilla
Open module: 19 rovere termotrattato
W 2246 H 216 D 525

SELF BOLD
Structure: 303 bronzo
Glass: 141 pepe opaco

In this photo
Wall panelling system: Modulor
Sliding door: Velaria

EN In the writing desk version, Self plan is available with an additional compartment in noce or rovere termotrattato, which can be freely placed on the countertop and integrated with drawers in synthetic leather and suede-effect internal lining. The wooden compartment is available in three widths of 640, 960 and 1280 mm and one height of 150 mm. The result is a fully functional home office workstation, equipped with an accessory cable duct for connecting the notebook or the table lamp.

IT Nella versione scrittoio, Self plan è disponibile con vano aggiuntivo in noce o rovere termotrattato, liberamente posizionabile sul piano d'appoggio e integrabile con cassettoni in similpelle e rivestimento interno dall'effetto scamosciato. Il vano in essenza è disponibile in tre lunghezze da 640, 960 e 1280 mm e un'unica altezza da 150 mm. Ne risulta una postazione home office perfettamente funzionale, con presa elettrica a scomparsa.

DE In der Schreibtischversion ist Self plan mit einem zusätzlichen Fach aus Noce und Rovere termotrattato erhältlich, das frei auf der Auflagefläche positioniert und in Schubladen aus Kunstleder und Innenfutter mit Wildledereffekt integriert werden kann. Das Holzfach ist in drei Breiten von 640, 960 und 1280 mm und einer Einzelhöhe von 150 mm erhältlich. Das Ergebnis ist eine perfekt funktionierende Home-Office Station mit einem zusätzlichen Kabelführungselement zum Anschließen von Notebooks oder Tischlampen.

FR Dans la version bureau, Self plan est disponible avec un compartiment supplémentaire en noce ou rovere termotrattato, pouvant être librement positionné sur le plan d'appui et pouvant être complété par de petits tiroirs en similicuir et revêtement interne avec effet suédé. Le compartiment en bois est disponible en trois largeurs de 640, 960 et 1280 mm et une seule hauteur de 150 mm. Cela permet d'obtenir une installation de home office parfaitement fonctionnelle, avec un élément passe câbles pour connecter un ordinateur ou une lampe de bureau.

ES En la versión escritorio, Self plan está disponible con un compartimento adicional en madera de noce o rovere termotrattato, que se puede colocar libremente sobre el tablero y que está integrado con pequeños cajones de simil cuero y un revestimiento interior con efecto de gamuza. El compartimento de madera está disponible en tres longitudes de 640, 960 y 1280 mm y una única altura de 150 mm. El resultado es una estación home office totalmente funcional, con un elemento pasacables adicional para conectar ordenadores portátiles o lámparas de escritorio.

RU Письменный стол Self plan предлагается с дополнительным отделением из ореха или термообработанного дуба, которое можно свободно расположить на столешнице и дополнить ящиками из Эко-кожи и внутренней отделкой с эффектом замши. Отсек из натурального дерева доступен в трех вариантах длины 640, 960 и 1280 мм и одной высоты 150 мм. В результате получается идеально функциональное рабочее место для домашнего офиса со скрытой электрической розеткой.

汉语 在办公桌的款式中, Self plan 亦提供以胡桃木或热处理橡木制成的附加收纳格, 可自由摆放在桌面上, 搭配以仿真皮革包覆、麂皮衬里的抽屉。以木材制成的收纳格配备隐藏式的电源插座, 有 640 毫米、960 毫米和 1280 毫米三种长度可供选择, 固定单一高度为 150 毫米, 功能完善的居家办公空间因而诞生。





SELF PLAN
 Structure: 83 piombo
 Glass: 312 grigio seta lucido
 Open modules: 15 noce
 W 3536 H 391 D 525

EOS
 Structure: 83 piombo
 Glass: 312 grigio seta lucido
 W 1200 H 75 D 285

SELF PLAN



SELF BOLD
 Structure: 303 bronzo
 Fronts: 17 noce sahara
 Top: 136 bronzo opaco
 W 2572 H 540 D 470

SELF PLAN
 Structure: 303 bronzo
 Top and back panel in synthetic leather: 157 arena
 Open module: 19 rovere termotrattato
 W 2256 H 216 D 525

EOS
 Structure: 303 bronzo
 Glass: 136 bronzo opaco
 W 2200 H 75 D 285



SELF PLAN
 Structure: 304 platino
 Glass: 97 avorio opaco
 W 3856 H 391 D 525

EOS
 Structure: 304 platino
 Glass: 97 avorio opaco
 W 1600 H 75 D 285

ALAMBRA
 Structure: 304 platino
 Glass: 67 riflettente chiaro
 Back panel: 68 specchio grigio
 W 424 H 1284 D 338

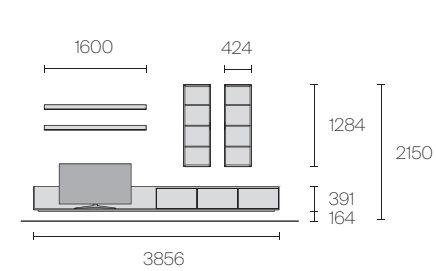

MODULOR
 Structure: 302 grafite
 Cladding: T044 acciaio
 W 5120 H 2614 D 60

SELF PLAN
 Structure: 302 grafite
 Glass: 88 grigio scuro lucido
 W 3856 H 391 D 525

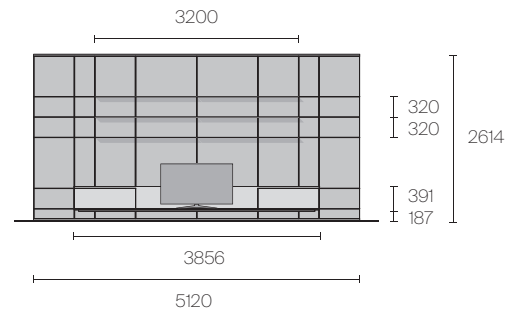

SELF PLAN
 Structure: 301 peltro
 Glass: 115 grigio cenere opaco
 Open modules: 19 rovere termotrattato
 W 2896 H 216 D 525

SELF BOLD
 Structure: 301 peltro
 Top: 134 peltro opaco
 Litech fronts: G004 grigio rigato
 W 2890 H 346 D 488

EOS
 Structure: 301 peltro
 Glass: 134 peltro opaco
 W 2600 H 75 D 285

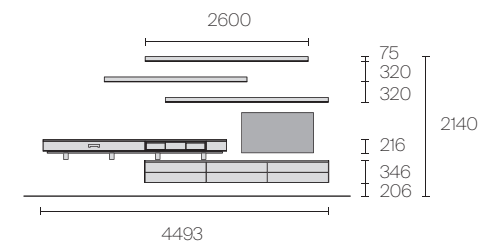

MODULOR
 Structure: 302 grafite
 Cladding: 20 rovere termotrattato sahara
 W 5120 H 2614 D 60

SELF PLAN
 Structure: 302 grafite
 Top and back panel in synthetic leather: 154 argilla
 W 2576 H 216 D 525

SELF BOLD
 Structure: 302 grafite
 Glass: 134 peltro opaco
 W 2570 H 346 D 488

ALAMBRA
 Structure: 302 grafite
 Glass: 67 riflettente chiaro
 Back panel: 68 specchio grigio
 W 1283 H 386 D 316

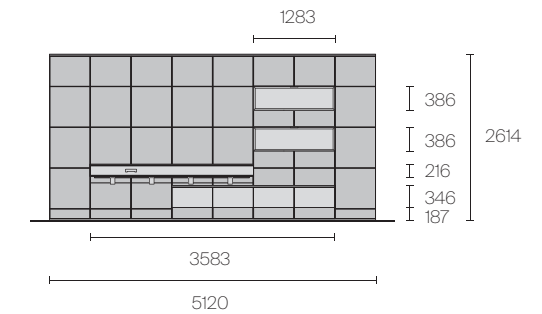

Self plan living

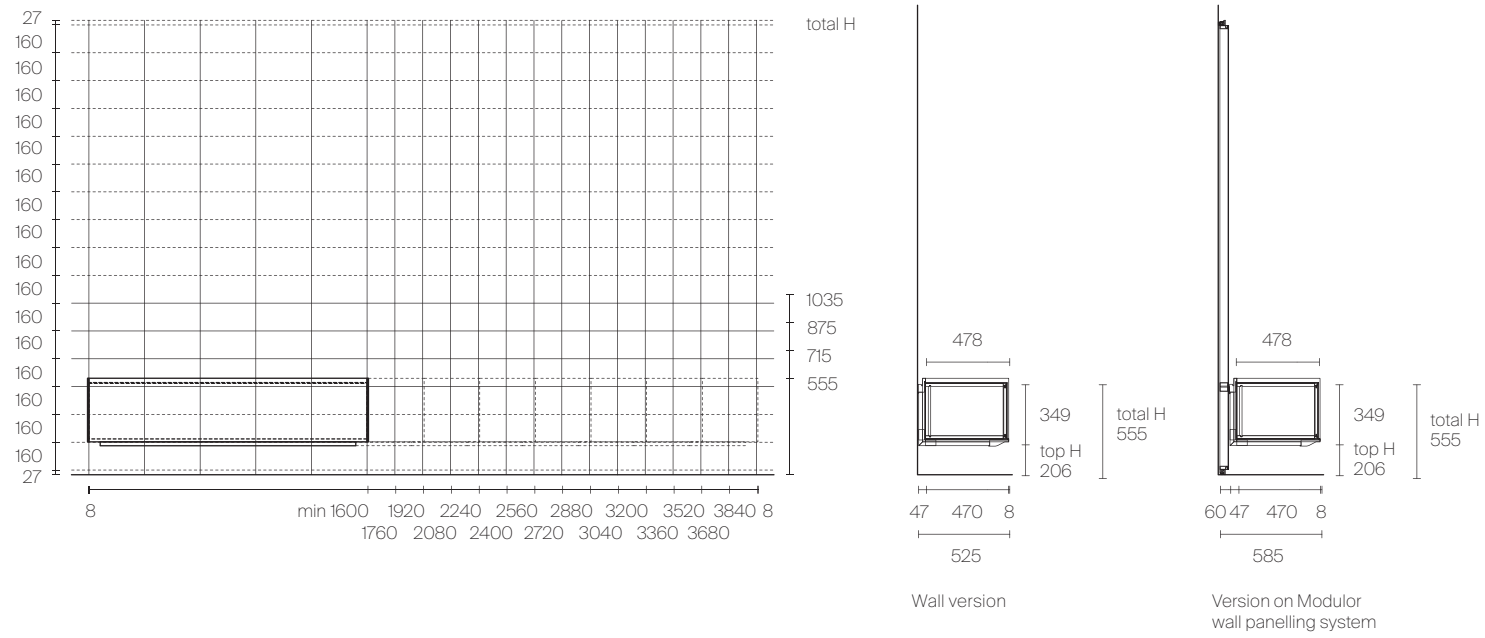

Self plan writing desk

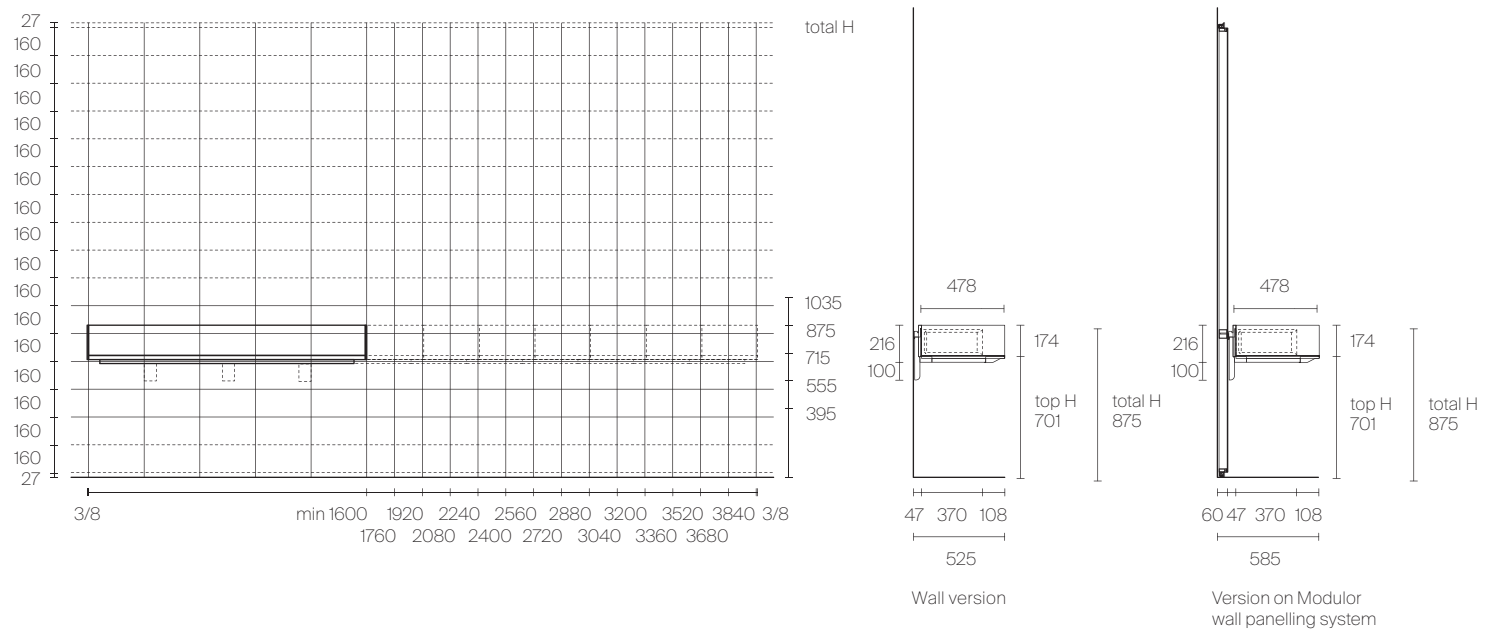

SIDE PANEL AESTHETICAL TYPOLOGIES



1. Living desk version with side panels. Top and back panel are available in lacquered glass.
2. Writing desk version with side panels. Top and back panel are available in lacquered glass or covered with synthetic leather.
3. Writing desk version without side panels. Top and back panel are available in lacquered glass or covered with synthetic leather.

Living version with side panels. Optional led lighting

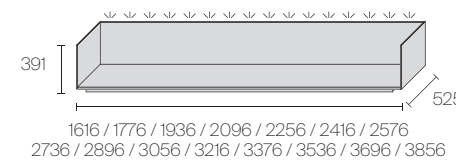

Writing desk version with side panels. Optional led lighting

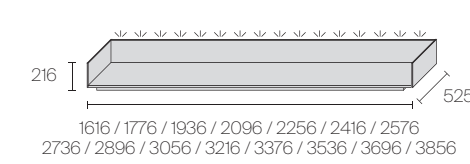

Writing desk version without side panels.



ACCESSORIES

Unit H 160 with 1 push drawer

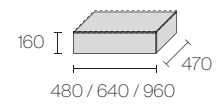

Unit H 320 with 2 push drawers

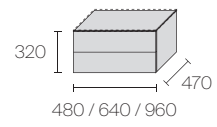

Unit H 320 with 1 push drawer

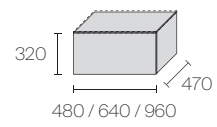

Synthetic leather mat for internal lining

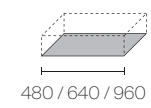

Unit H 160 with flap door

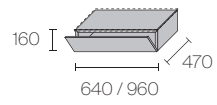

Unit H 320 with flap door

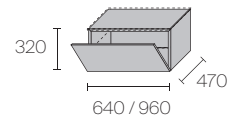

Optional internal back panel for unit with flap door

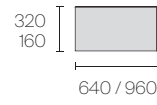

Battery led spotlight for unit with flap door

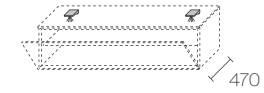

Cabinet with glass flap door

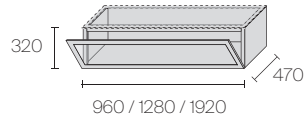

Led lighting for cabinet with glass flap door

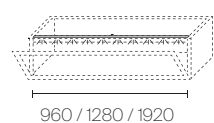

Wooden open modules for living version

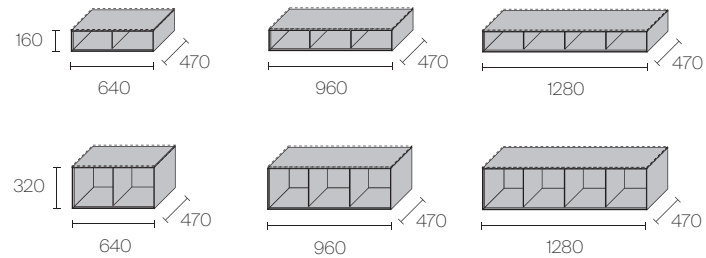

Technical open modules

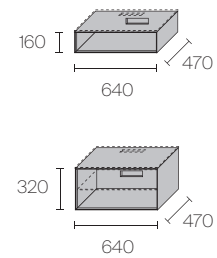

Open modules for writing desk version

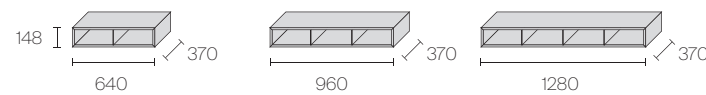

Synthetic leather drawer for open module

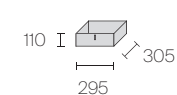

ACCESSORIES



1



2

1. Closed integrated multiple socket
2. Open integrated multiple socket
3. Cable duct



3

Integrated multiple socket available in European, CH, UK and USA configurations



Cable duct

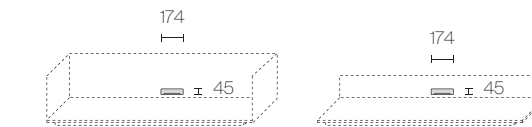

FINISHINGS

Structure and aluminium finishing side



Base with feet, skirting, drawer and hinged door profile

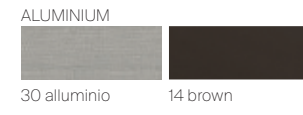

Glass finishing side



Self Plan writing desk top and back panel

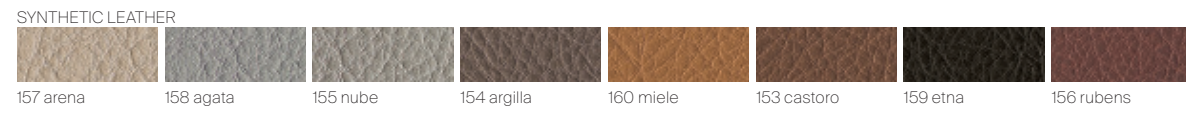

Self Plan living top and back panel



Finishing top for units

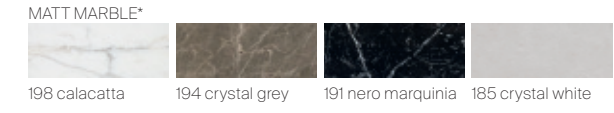
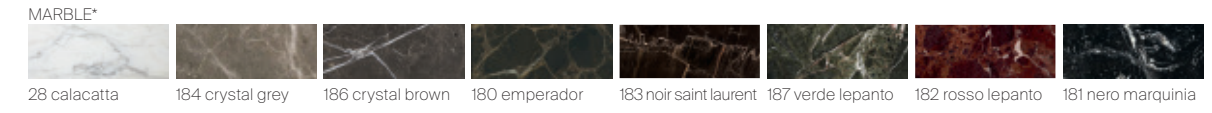
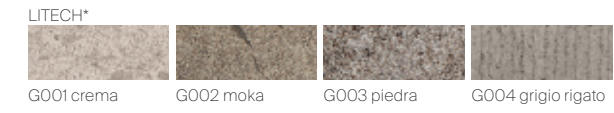
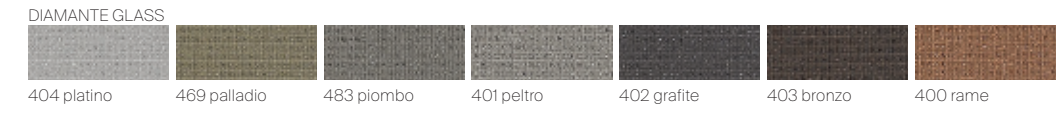
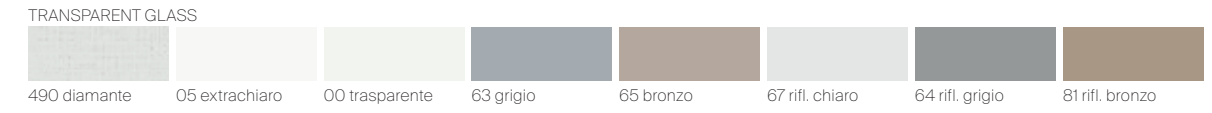
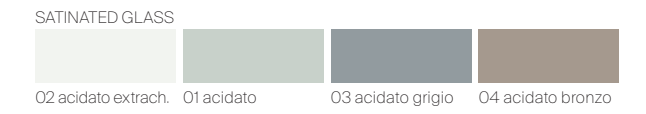
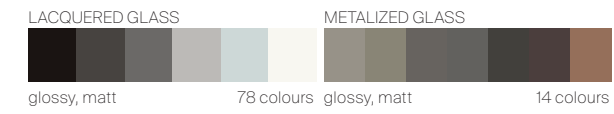

* Only available for Bold version

Internal glass shelf with aluminium perimeter profile

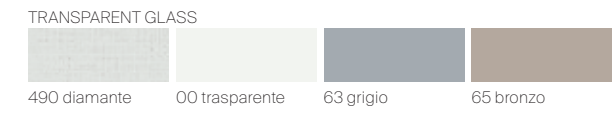
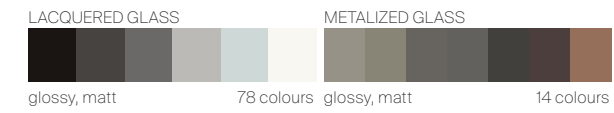

Transparent doors

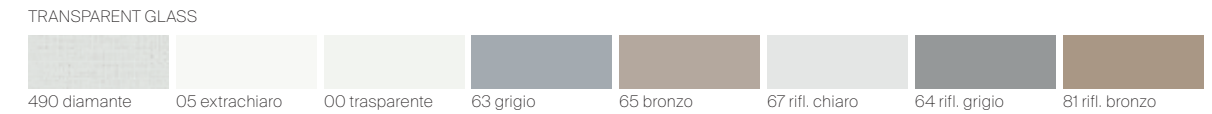

Drawer, hinged door, flap door, finishing back panel

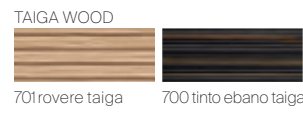
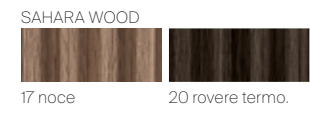
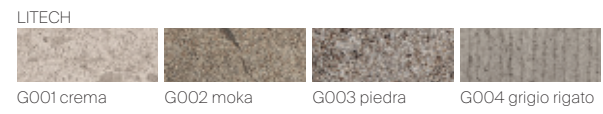
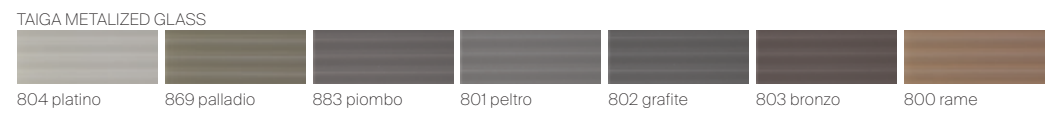
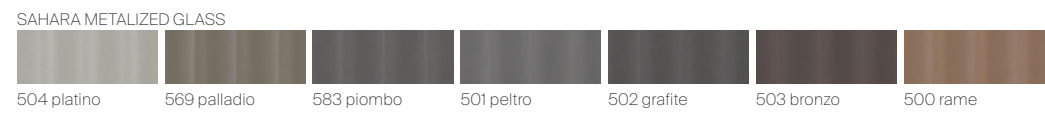
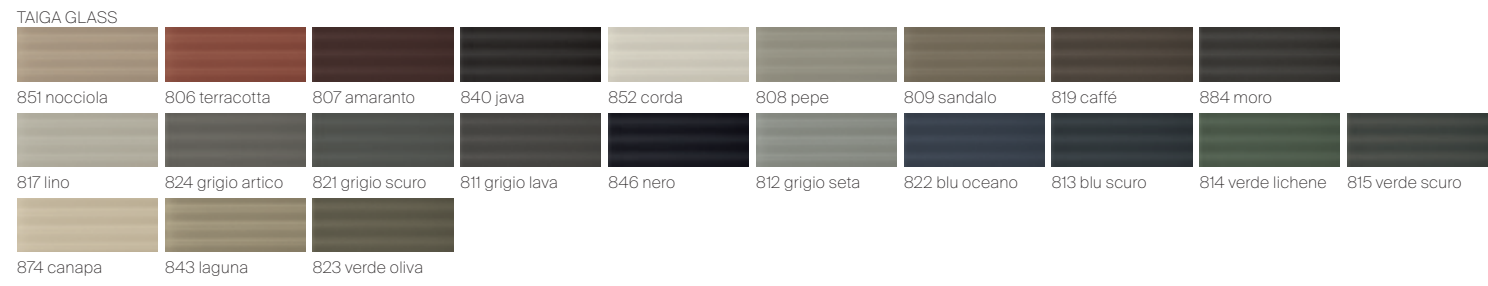
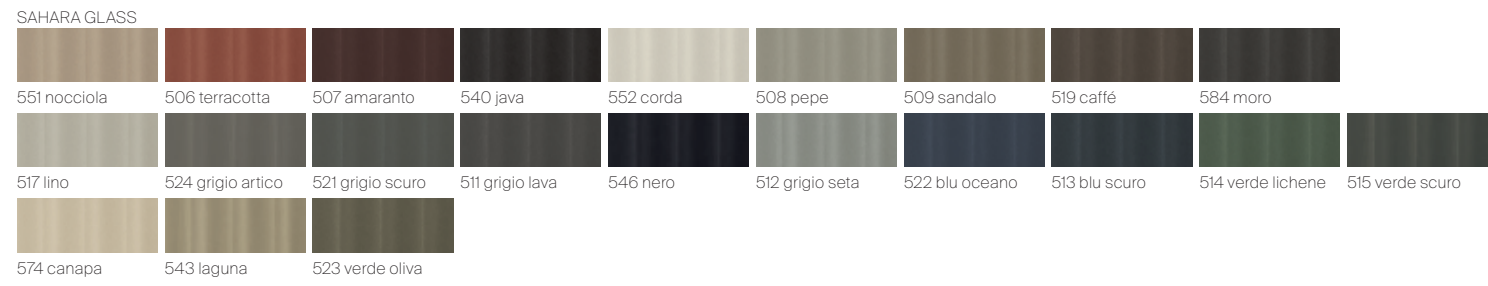

Open module

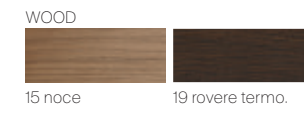
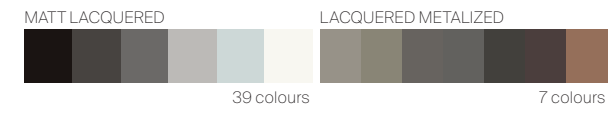

Open module for desk D370, secretaire internal structure

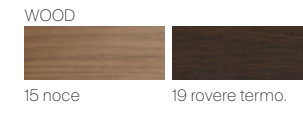

Internal melamine, drawers interior

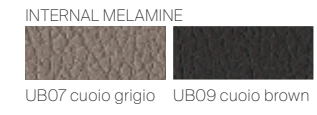

Optional internal back panel for hinged and flap door units and open module

NEUTRAL GLASS

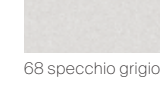

Drawer covered with synthetic leather for open units, mat for internal drawer lining

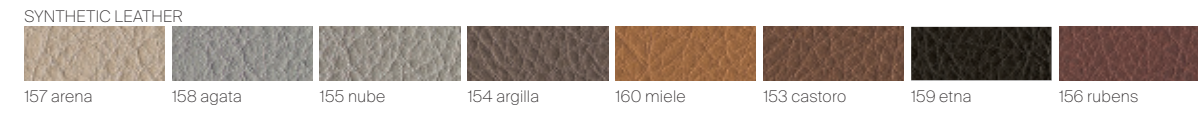

QUALITY AS THE MAIN PURPOSE, ALWAYS AND IN EVERY ASPECT, WITH THIS MISSION RIMADESIO IS CONSTANTLY SEARCHING FOR SOLUTIONS TO IMPROVE ITS OWN ECOLOGICAL STANDARDS.

OBJECTIVE OBTAINED THANKS TO THE USE OF PRECIOUS AND RECYCLABLE MATERIALS, TO THE ABSENCE OF SUBSTANCES THAT CAN BE TOXIC TO HUMANS OR HARMFUL TO THE ENVIRONMENT IN EVERY PHASE OF THE PRODUCTIVE PROCESS, TO THE USE OF TECHNOLOGY AND EVOLVED MACHINERY, POWERED BY CLEAN ENERGY DERIVED FROM PHOTOVOLTAIC SYSTEMS, INSTALLED ON THE GIUSSANO HEADQUARTERS ROOF.

ALUMINIUM, GLASS, WOOD: FULLY RECYCLABLE AND PARTLY ALREADY RECYCLED MATERIALS.

PROOFS OF A REINFORCED GREEN DNA AND WIDE COHERENCE, SIGNALS OF A CONTINUOUS RESEARCH AND A GLANCE TOWARDS THE FUTURE, THAT TAKES SHAPE IN THE TECHNOLOGICAL INNOVATION OF SYSTEMS, DOORS AND FURNITURE, MADE WITH THE AWARENESS OF WANTING TO ENTRUST HUMANS ONLY WITH HIGH VALUE-ADDED ACTIVITIES.

EXCELLENCE SUSTAINABILITY PROJECT

IT Perseguire la qualità, sempre, sotto tutti gli aspetti. Con questa mission Rimadesio ricerca costantemente soluzioni volte a migliorare i propri standard qualitativi ecologici. Obiettivo ottenuto sinergicamente, grazie all'utilizzo di materiali preziosi e riciclabili, all'assenza di sostanze tossiche per l'uomo e nocive per l'ambiente in ogni fase del processo produttivo, all'impiego di tecnologie e macchinari evoluti alimentati con energia pulita proveniente da impianti fotovoltaici, installati sulla copertura dell'headquarter di Giussano. Alluminio, vetro, legno, materiali totalmente riciclabili e in parte già riciclati, ma anche le vernici prive di solventi di Ecoloursystem e i sistemi di imballaggio ecologici. Testimonianze di un dna green consolidato e di una coerenza trasversale, segnali di una continua attività di ricerca e di uno sguardo sempre proteso al futuro che si declina nell'innovazione tecnologica di sistemi, porte ed arredi, realizzati con la consapevolezza di voler affidare all'uomo solo attività dall'alto valore aggiunto.

DE Stets um Qualität bemüht, und zwar in allen Bereichen. Mit dieser Mission im Blick sucht Rimadesio laufend nach Lösungen, um seine ökologischen Qualitätsstandards zu verbessern. Dieses Ziel wurde dank der Verwendung wertvoller und wiederverwertbarer Materialien, dem Verzicht auf für den Menschen giftige und umweltschädliche Stoffe in jeder Phase des Produktionsprozesses und dem Einsatz fortschrittlicher Technologien und Maschinen, die mit sauberer Energie aus den auf dem Dach des Giussano-Hauptsitzes installierten Photovoltaikanlagen betrieben werden, synergetisch erreicht. Aluminium, Glas, Holz, vollständig recycelbare und teilweise bereits recycelte Materialien, aber auch die Lösungsmittelfreien Farben von Ecoloursystem und umweltfreundliche Verpackungssysteme. Ein Zeugnis einer fundierten grünen DNA und einer transversalen Kohärenz, Zeichen einer kontinuierlichen Forschungstätigkeit und eines stets in die Zukunft gerichteten Blicks, der sich in der technologischen Innovation von Systemen, Türen und Einrichtungsgegenständen ausdrückt, die in dem Bewusstsein realisiert werden, den Menschen nur Tätigkeiten mit hohem Mehrwert anzuvertrauen.

FR Poursuivre la qualité, toujours, et à tous les égards. Avec cette mission Rimadesio recherche constamment de solutions au fin d'améliorer ses normes de qualité écologique. Objectif atteint, grâce à l'utilisation de matériaux précieux et recyclables, l'absence à chaque étape de la production de substances toxiques nocives pour l'homme et l'environnement, l'utilisation de technologies et des machines avancées alimentées par l'énergie solaire après l'installation sur le toit de l'usine à Giussano de systèmes photovoltaïques. Aluminium, verre, bois, des matériaux entièrement recyclables et déjà en partie recyclés, mais aussi peinture Ecoloursystem sans solvants et systèmes d'emballage respectueux de l'environnement. Témoignages d'un adn "vert" consolidé et d'une cohérence transversale, signes de recherche continue et d'une tendance à regarder en avant, qui correspond bien à l'innovation technologique des systèmes, des portes et des meubles, réalisés avec la conscience que l'apport de l'homme dans la production ne peut qu'avoir un valeur ajoutée.

ES Perseguir la calidad, siempre, en todos los aspectos. Con esta misión Rimadesio busca constantemente soluciones destinadas a mejorar sus estándares de calidad ecológica. Objetivo conseguido sinérgicamente, gracias al uso de materiales preciosos y reciclables, a la ausencia de sustancias tóxicas para los seres humanos y nocivas para el medio ambiente en cada etapa del proceso de producción, al uso de tecnologías y máquinas avanzadas alimentadas por energía limpia a partir de sistemas fotovoltaicos, instalados en la cobertura del headquarter de Giussano. Aluminio, cristal, madera, materiales completamente reciclables y, en parte, ya reciclados, sino también las pinturas Ecoloursystem libres de disolventes y los sistemas de embalaje ecológicos. Testimonios de un adn green consolidado y una coherencia transversal, señales de una continua investigación y de una vista siempre tendida al futuro que se declina en la innovación tecnológica de sistemas, puertas y muebles, realizados con el conocimiento que desea confiar al hombre sólo actividades de alto valor añadido.

RU Обеспечение качества всегда и во всем. И, в том числе, для достижения этой цели Компания Rimadesio находится в постоянном поиске решений, направленных на улучшение экологических стандартов качества. Эта цель была достигнута благодаря использованию на каждом этапе производственного процесса ценных материалов, пригодных для вторичной переработки, отсутствию токсичных для человека и вредных для окружающей среды веществ, а также благодаря внедрению передовых технологий и оборудования, работающего на чистой энергии от фотоэлектрических систем, установленных на крыше штаб-квартиры компании в г. Джуссано. Компания использует такие материалы, как алюминий, стекло, дерево – полностью перерабатываемые и уже частично переработанные материалы, краски Ecoloursystem, не содержащие растворителей, а также экологически упаковку. Свидетельство консолидированной экологичности и непрерывной последовательности, исследовательской деятельности и взгляда, всегда устремленного в будущее, что выражается в технологических инновациях систем, дверей и мебели, произведенных с осознанием того, что человеку стоит поручать только деятельность с высокой добавленной стоимостью.

汉语 始终至终追求全方位的卓越品质。Rimadesio 肩负使命，不断探索精进生态质量标准的解决方案。品牌目标之达成有赖于珍贵的可回收材料，该材料在所有制造阶段皆不会产生危害人体和环境之有毒物质，同时结合业界前沿的技术以及先进机械装置；而位于朱塞诺 (Giussano) 品牌总部建筑屋顶上的光伏发电设备为上述之机械装置供给干净的能源。除了可完全回收和已部分回收的铝材、玻璃、木材等材料之外，还有环保色彩系统 (Ecoloursystem) 的无溶剂涂料和生态环保型包装。深植的绿色 DNA、跨领域的协同性、持续的研究工作以及具前瞻性的未来展望皆体现在家具系统、各式门类 and 家具配件的技术创新上，其本着信赖人类才能胜任高附加价值活动的意念研发而成。

GUIDE TO RIMADESIO QUALITY

TEMPERED GLASSES

Single tempered glasses cooked at a temperature of 650 °C. Mechanical resistance 5 times superior in comparison to a normal glass. In case of breaking it crumbles in harmless tiny fragments. In accordance with the UNI EN 12150, UNI 7697 and UNI EN 12600 rules with reference to the security of glasses for decoration purposes.

LAMINATED GLASSES

Double glasses. Between the two glasses a thin plastic film is inserted. Transparent and invisible, it perfectly sticks to both surfaces. Both surfaces are perfectly smooth.Resistance to breaking in accordance with the UNI EN ISO 12543, UNI 7697 and UNI EN 12600 rules. The plastic film witholds the fragments in case of breaking.

GLASS WITH METAL NET AND MESH

Double laminated glasses. Between the two extra-clear glasses and two thin plastic films a micronet fabric is inserted. Through a sophisticated process a metal layer is applied on the fabric, thus creating a characteristic effect of semi transparency. The reflections of the light on the surface of the metallic net are provided by using an extra-clear float glass, which allows maximum transparency and high light transmissions, thanks to the low content of iron oxides. Following the process of hot stratification, the fabric might show minor wave effect, which give the material its characteristic materic and natural look.

ECOLORSYSTEM LACQUERED GLASSES

Ecolorsystem is the name that distinguishes the exclusive Rimadesio lacquered glass collection in glossy and matt finishing. Ecological colours produced using exclusively water paints of latest generation, cooked at 110° C. A production technology in the area of glass, with a fully robotised in-house plant that ensures very high quality results and a low environmental impact work cycle. Corrosion resistance conforms to the UNI EN ISO 9227 standard. Temperature fluctuation resistance conforms to the UNI 9429 standard. The colour is inside the double glass, safe from stains, dust and humidity. The thickness of the glass creates an exclusive "depth" effect.

VETRI TEMPERATI

Vetri singoli, sottoposti al trattamento della tempra ovvero ad una cottura alla temperatura di 650 °C. Resistenza meccanica di 5 volte superiore rispetto ad un vetro normale. In caso di rottura si sbriciola in minuti frammenti inoffensivi. Conformi alle norme UNI EN 12150, UNI 7697 e UNI EN 12600 in materia di sicurezza per i vetri d'arredamento.

VETRI STRATIFICATI

Vetri doppi. Fra i due vetri è inserita una sottile pellicola di materiale plastico, trasparente ed invisibile, che aderisce completamente alle due superfici. Entrambe le superfici sono perfettamente lisce. Resistenza alla rottura conforme alle norme UNI EN ISO 12543, UNI 7697 e UNI EN 12600. La pellicola di materiale plastico in caso di rottura trattiene i frammenti.

VETRI STRATIFICATI RETE, MAGLIA E FIBRA

Vetri doppi stratificati. Tra i due vetri extrachiari e le due sottili pellicole in materiale plastico, è inserito un tessuto in microrete sul quale, tramite un sofisticato processo di materizzazione, viene depositato uno strato metallico che crea un caratteristico effetto di semitrasparenza. Le riflessioni della luce sulla superficie della rete metallizzata sono ottenute con l'utilizzo del vetro float extrachiaro che, grazie al basso contenuto di ossidi di ferro, garantisce la massima trasparenza e un'elevata trasmissione luminosa. Il tessuto, a seguito del processo di stratifica a caldo, può presentare delle leggere ondulazioni che conferiscono al materiale il suo caratteristico aspetto materico e naturale.

VETRI LACCATI ECOLORSYSTEM

Ecolorsystem è la denominazione che contraddistingue l'esclusiva collezione di vetri laccati Rimadesio, disponibili in finitura lucida e opaca. Colori ecologici perché prodotti utilizzando esclusivamente vernici all'acqua di ultima generazione, con cottura a 110°C. Una tecnologia produttiva all'avanguardia nell'ambito del vetro, con impianti interni totalmente robotizzati che assicurano risultati di altissima qualità e un ciclo di lavorazione a basso impatto ambientale. Resistenza alla corrosione conforme alla norma UNI EN ISO 9227. Resistenza agli sbalzi di temperatura conforme alla norma UNI 9429. Colori inalterabili nel tempo perché applicati sulla superficie interna del vetro, al sicuro da macchie, polvere e umidità. Lo spessore del vetro crea un esclusivo effetto di "profondità".

TEMPERIERTES GLAS

Einzelgläser, die einer Härtingsbehandlung oder einer Kochtemperatur von 650 °C unterzogen wurden. Mechanische Beständigkeit 5 mal höher als bei normalem Glas. Im Bruchfall zerbröckeln harmlose Bruchstücke in Minuten. Entspricht den Normen UNI EN 12150, UNI 7697 und UNI EN 12600 für die Sicherheit von Möbelgläsern.

SCHICHTGLAS

Doppelgläser. Zwischen den beiden Gläsern befindet sich ein dünner Film aus transparentem und unsichtbarem Kunststoff, der vollständig an den beiden Oberflächen haftet. Beide Oberflächen sind komplett glatt. Die Bruchfestigkeit entspricht den Normen UNI EN ISO 12543, UNI 7697 und UNI EN 12600. Die Kunststoffolie bewahrt im Bruchfall die Bruchstücke.

SCHICHTGLAS MIT METALLNETZ, GLASGITTER UND FASER

Hierbei handelt es sich um Doppel-schichtgläser. Zwischen den zwei Extralight-Glasscheiben und den beiden unsichtbaren Plastikfolien wird ein Metallnetz deposited sur ce tissu, créant un effet caractéristique translucide. Les reflets de la lumière sur la surface de la maille métallique sont obtenus avec l'utilisation du verre float extra clair, qui, grâce à un faible teneur de oxydes de fer, permet un maximum de transparence et de transmission de la lumière. Suite au procédé de stratification à chaud, le tissu peut présenter de petites ondulations, qui apportent au matériau son aspect caractéristique et naturel.

LACKIERTE GLÄSER ECOLORSYSTEM

Ecolorsystem ist der Name der lackierten Glas-Kollektion von Rimadesio in der glänzend und matte Ausführung verfügbar. Absolut oekologische Farben, da die modernsten Lackierungen, auf Wasser-Basis, an einer Temperatur von 110° gekocht werden. Eine fortschrittliche Produktionstechnik in der Glasverarbeitung auf einer vollautomatisierten Anlage, die Ergebnisse höchster Qualität und gleichzeitig umweltfreundliche Verarbeitungsverfahren gewährleistet. Korrosion-sprüfung gemäß Bestimmung UNI EN ISO 9227. Temperaturwechselprüfung gemäß Bestimmung UNI 9429. Unverändliche Farben da die Farbung sich im Innen des Doppelglases, geschützt vor Staub, Kratzen und Feuchtigkeit, befindet. Die Dicke des Glases erzeugt eine einzigartige Tiefwirkung.

VERRES TREMPÉS

Verres simples, soumis au traitement de trempe et donc à une température de cuisson de 650 °C. Résistance mécanique 5 fois supérieure à celle du verre normal. En cas de rupture, des fragments inoffensifs s'effritent en quelques minutes. Conforme aux normes UNI EN 12150, UNI 7697 et UNI EN 12600 pour la sécurité des verres pour les meubles.

VERRES STRATIFIÉS

Double verres. Entre les deux verres se trouve une fine pellicule de matière plastique, transparente et invisible, qui adhère complètement aux deux surfaces. Les deux surfaces sont parfaitement lisses. La résistance aux ruptures est conforme aux normes UNI EN ISO 12543, UNI 7697 et UNI EN 12600. La pellicule retient les fragments en cas de rupture.

VERRE FEUILLETÉ AVEC NET, MAILLE ET FIBRA

Double verre stratifié. Entre les deux verres extra clair et les deux films fins de matière plastique un tissu en micro maille est ajouté. A travers un procédé avancé de materisation un couche métallique est déposé sur ce tissu, créant un effet caractéristique translucide. Les reflets de la lumière sur la surface de la maille métallique sont obtenus avec l'utilisation du verre float extra clair, qui, grâce à un faible teneur de oxydes de fer, permet un maximum de transparence et de transmission de la lumière. Suite au procédé de stratification à chaud, le tissu peut présenter de petites ondulations, qui apportent au matériau son aspect caractéristique et naturel.

VERRES LAQUÉS ECOLORSYSTEM

Ecolorsystem est le nom qui caractérise la collection exclusive de verres laqués de Rimadesio disponibles en finition brillante et mate. Couleurs écologiques, parce que produits en utilisant exclusivement vernis à l'eau de dernière génération, cuites à 110°. Une technologie de production avant-gardiste dans le domaine du verre, avec des équipements internes entièrement robotisés qui assurent des résultats de grande qualité et un cycle de production ayant un impact très faible sur l'environnement. Résistance à la corrosion conformément à la norme UNI EN ISO 9227. Résistance aux écarts de température conformément à la norme UNI 9429. Couleurs inaltérables parce qu'ils sont appliqués dans la surface interne du verre, pour protéger de la poussière humidité et taches. L'épaisseur du verre crée un exclusif effet profondeur.

CRISTALES TEMPLADOS

Vidrios simples, sometidos al tratamiento de templado a una temperatura de cocción de 650 °C. Resistencia mecánica de 5 veces mayor que el vidrio normal. En caso de rotura, se desmoronan fragmentos inofensivos. Conforme a las normas UNI EN 12150, UNI 7697 y UNI EN 12600 en materia de seguridad para los cristales en el amueblamiento.

CRISTALES ESTRATIFICADO

Vidrios dobles. Entre los dos vidrios hay una película fina de material plástico, transparente e invisible, que se adhiere completamente a las dos superficies. Ambas superficies son perfectamente lisas. La resistencia a la rotura cumple con las normas UNI EN ISO 12543, UNI 7697 y UNI EN 12600. La película de plástico en caso de rotura retiene los fragmentos.

CRISTALES ESTRATIFICADOS RED METÁLICA, MAILLA Y FIBRA

Cristales dobles estratificados. Entre los dos cristales extraclaros y las dos capas sintéticas, está inserido en un tejido de microred en el que, a través de un sofisticado proceso se deposita una característica de efecto semitransparente. Los reflejos de la luz sobre la superficie de la red metálica se proporcionan con el uso del vidrio float extraclaro que, gracias a su bajo contenido en óxidos de hierro, asegura la máxima transparencia y una alta transmisión de luz. El tejido, siguiendo el proceso de estratificación en caliente, puede presentar ligeras ondulaciones que dan al material su aspecto característico natural.

CRISTALES LACADOS ECOLORSYSTEM

Ecolorsystem es la denominación que marca la exclusiva colección de los cristales lacados Rimadesio, disponibles en acabado brillante y mate. Colores ecológicos porque productos utilizando exclusivamente pinturas al agua de última generación, con cocción a 110°. Una tecnología productiva a la vanguardia en el ámbito del cristal, con unas instalaciones internas totalmente robotizadas que aseguran resultados de altísima calidad y un ciclo de tratamiento respetuoso del medio ambiente. Resistencia a la corrosión conforme a la norma UNI EN ISO 9227. Resistencia a las variaciones de temperatura conforme a la norma UNI 9429. Colores inalterables en el tiempo porque aplicados en la superficie interior del cristal, al resguardo de manchas, polvo y humedad. El grosor del cristal crea un exclusivo efecto de "profundidad".

ЗАКАЛЕННОЕ СТЕКЛО

Механическая прочность одинарных стекол, подвергнутых закалке, т.е. обжигу при температуре 650°C, в 5 раз выше, чем у обычного стекла. Если такое стекло разбить, оно рассыпется на мелкие неопасные осколки. Соответствует стандартам безопасности UNI EN 12150, UNI 7697 и UNI EN 12600 для мебельного стекла.

МНОГОСЛОЙНОЕ СТЕКЛО

Двойные стекла. Тонкая, прозрачная и невидимая пластиковая пленка прокладывается между двумя стеклами и полностью приклеивается к обеим поверхностям. Обе поверхности идеально гладкие. Проверка прочности на разрыв была выполнена в соответствии со стандартами UNI EN ISO 12543, UNI 7697 и UNI EN 12600. Эта пленка способна удерживать осколки разбившегося стекла.

МНОГОСЛОЙНОЕ СТЕКЛО, СТЕКЛО С СЕТКОЙ

Многослойное двойное стекло. Между двумя сверхпрозрачными стеклами и двумя тонкими пластиковыми пленками вставляется микросетчатое полотно, на которое в ходе сложного производственного процесса наносится металлический слой, благодаря чему и формируется характерный полупрозрачный эффект. Отражение света на поверхности металлизированной сетки достигается за счет использования сверхчистого флоат-стекла, которое из-за низкого содержания оксида железа гарантирует максимальную прозрачность и высокую светопропускную способность. В результате процесса наслаивания в горячем виде полотно приобретает небольшие волнистости, которые придают материалу характерную текстуру и натуральный вид.

ЛАКИРОВАННОЕ СТЕКЛО ECOLORSYSTEM

Ecolorsystem — это название эксклюзивной коллекции лакированного стекла Rimadesio, доступной в глянцевой и матовой отделке. Коллекция характеризуется мягкими спокойными цветами, поскольку при их производстве используются только краски последнего поколения на водной основе, запекаемые при температуре 110°C. В стекольной промышленности в настоящее время внедряются современные производственные технологии, полностью роботизированные заводы, обеспечивающие высокое качество и незначительное воздействие на окружающую среду. Коррозионная стойкость соответствует требованиям положений стандарта EN ISO 9227. Устойчивость к изменениям температуры соответствует требованиям стандарта UNI 9429. Цвет характеризуется исключительной долговечностью, поскольку краски наносятся на внутреннюю поверхность стекла, защищенную от пятен, пыли и влаги. Толщина стекла создает уникальный эффект «глубины».

钢化玻璃 单片玻璃通过淬火工艺,即经 650 °C 高温烧制而成,其机械阻力相较于普通玻璃高出 5 倍。钢化玻璃破裂时会碎成不易伤人的细小碎片。符合家具玻璃安全材质 UNI EN 12150、UNI 7697 以及 UNI EN 12600 的标准。

夹层玻璃

双层玻璃。在两片玻璃之间夹有一层纤薄、透明、无形的塑料薄膜,其完全贴合两片玻璃的表面。两片玻璃的表面皆光滑无比。其抗裂性能符合 UNI EN ISO 12543、UNI 7697 以及 UNI EN 12600 的标准。玻璃破裂时,其碎片会粘在塑料薄膜上,裂而不散。

网夹层玻璃、网格夹层玻璃和纤维夹层玻璃

双层夹层玻璃。在两片超清玻璃和两层纤薄的塑料薄膜之间夹入一层微型网状织物,一道细腻的材质加工工艺,会在织物上覆盖一层金属并创造半透明的特殊效果。使用超清浮法玻璃产出金属网表面的光线反射,因玻璃的氧化铁含量低,可确保最大透明度和高透光率。通过热分层加工工艺,夹入的织物会有不平整的现象,从而呈现出具有特色的材质纹理和自然感的外观。

环保色彩系统 (Ecolorsystem) 烤漆玻璃

Ecolorsystem 为 Rimadesio 烤漆玻璃独家系列的名称,有亮面和哑光两种表面处理可供选择。由于仅使用最新一代的水性涂料搭配 110°C 烘烤工序完成而被称为生态环保性色彩;其为超前玻璃业界的生产技术,而全机器人化的内部设备确保极高的产品质量和低环境冲击的加工循环。其抗腐蚀程度符合 UNI EN ISO 9227 的标准。其抗温度急变性符合 UNI 9429 的标准。因色彩涂层夹于玻璃内层,因此不会褪色且不受脏污、灰尘和湿气的影响。玻璃的厚度创造出一种独特的“深度”效果。

ECOLORSYSTEM LACQUERED GLASS

GLOSSY MATT		GLOSSY MATT		GLOSSY MATT		GLOSSY MATT		GLOSSY MATT		GLOSSY MATT			
305	138 cipria	45	97 avorio	59	105 grigio chiaro	40	115 grigio cenere	53	95 bianco neve	50	108 bianco latte		
51	113 nocciola	52	107 corda	56	98 lino	312	145 grigio seta	47	96 grigio perla	78	114 sabbia		
306	139 terracotta	85	130 tufo	310	143 creta	38	121 azzurro cera	36	117 blu Londra	74	110 canapa		
76	116 rosso india	308	141 pepe	317	600 grigio artico	35	100 blu notte	39	122 verde inglese	73	109 giallo kashmir		
75	129 amaranto	309	142 sandalo	88	132 grigio scuro	86	131 blu oceano	314	147 verde lichene	43	119 laguna		
307	140 java	58	99 caffè	311	144 grigio lava	313	146 blu scuro	315	148 verde scuro	33	111 verde oliva		
		84	128 moro	46	102 nero					316	149 verde terra		

ECOLORSYSTEM SAHARA GLASS

551	nocciola sahara	552	corda sahara	517	lino sahara	512	grigio seta sahara	514	verde lichene sahara	574	canapa sahara
506	terracotta sahara	508	pepe sahara	524	grigio artico sahara	522	blu oceano sahara	515	verde scuro sahara	543	laguna sahara
507	amaranto sahara	509	sandalo sahara	521	grigio scuro sahara	513	blu scuro sahara			523	verde oliva sahara
540	java sahara	519	caffè sahara	511	grigio lava sahara						
		584	moro sahara	546	nero sahara						

ECOLORSYSTEM TAIGA GLASS

851	nocciola taiga	852	corda taiga	817	lino taiga	812	grigio seta taiga	814	verde lichene taiga	874	canapa taiga
806	terracotta taiga	808	pepe taiga	824	grigio artico taiga	822	blu oceano taiga	815	verde scuro taiga	843	laguna taiga
807	amaranto taiga	809	sandalo taiga	821	grigio scuro taiga	813	blu scuro taiga			823	verde oliva taiga
840	java taiga	819	caffè taiga	811	grigio lava taiga						
		884	moro taiga	846	nero taiga						

ECOLORSYSTEM METALIZED GLASS

GLOSSY MATT		SAHARA		TAIGA		DIAMANTE	
304	137 platino	504	platino sahara	804	platino taiga	404	platino diamante
69	126 palladio	569	palladio sahara	869	palladio taiga	469	palladio diamante
83	127 piombo	583	piombo sahara	883	piombo taiga	483	piombo diamante
301	134 peltro	501	peltro sahara	801	peltro taiga	401	peltro diamante
302	135 grafite	502	grafite sahara	802	grafite taiga	402	grafite diamante
303	136 bronzo	503	bronzo sahara	803	bronzo taiga	403	bronzo diamante
300	133 rame	500	rame sahara	800	rame taiga	400	rame diamante

NEUTRAL GLASS

55	specchio
68	specchio grigio

TRANSPARENT GLASS

890	trasparente taiga
590	trasparente sahara
490	trasparente diamante
05	trasparente extrachiaro
00	trasparente
63	grigio trasparente
65	bronzo trasparente
390	verde trasparente
391	blu trasparente

SATINATED GLASS

67	riflettente chiaro
64	riflettente grigio
81	riflettente bronzo
891	acidato taiga
591	acidato sahara
02	acidato extrachiaro
01	acidato
03	acidato grigio
04	acidato bronzo
82	nuvola extrachiaro
80	nuvola

MESH GLASS

60	rete alluminio
61	rete inox
62	rete bronzo
66	maglia gold
87	maglia rame
06	fibra argento
08	fibra bronzo







REFLEX GLASS

90	bianco reflex
92	kaki reflex
94	cacao reflex
89	nero reflex





ECOLORSYSTEM MATT LACQUERED

 305 cipria	 45 avorio	 59 grigio chiaro	 40 grigio cenere	 53 bianco neve	 16 bianco latte
 51 nocciola	 52 corda	 56 lino	 312 grigio seta	 47 grigio perla	 78 sabbia
 306 terracotta	 85 tufo	 310 creta	 38 azzurro cera	 36 blu Londra	 74 canapa
 76 rosso india	 308 pepe	 317 grigio artico	 35 blu notte	 39 verde inglese	 73 giallo kashmir
 75 amaranto	 309 sandalo	 88 grigio scuro	 86 blu oceano	 314 verde lichene	 43 laguna
 307 java	 58 caffè	 311 grigio lava	 313 blu scuro	 315 verde scuro	 33 verde oliva
	 84 moro	 13 nero			 316 verde terra

ECOLORSYSTEM LACQUERED METALIZED

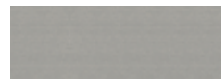
 304 platino	 302 grafite
 69 palladio	 303 bronzo
 83 piombo	 300 rame
 301 petro	

ALUMINIUM

 31 alluminio lucido
 30 alluminio
 14 brown
 318 nickel grigio
 22 nero lucido

LEATHER

 C23 bianco ghiaccio
 C17 sand
 C29 toupè
 C22 caramello
 C28 fango
 C11 moka

SYNTHETIC LEATHER

 157 arena
 158 agata
 155 nube
 154 argilla
 160 miele
 153 castoro
 159 etna
 156 rubens









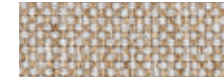

LUX FABRIC

 T006 gesso
 T052 segale
 T044 acciaio
 T012 marmotta
 T042 ruggine
 T051 salvia





MATERIAL FABRIC

 T020 nebbia
 T019 papiro
 T009 piuma
 T017 roccia
 T001 terracotta
 T003 brandy
 T018 tabacco

TECH FABRIC

 TT01 duna
 TT03 tortora
 TT05 mosto
 TT07 antracite
 TT09 fumo
 TT10 ghiaccio
 TT11 giada
 TT19 canyon
 TT20 dolomiti
 TT21 cedro

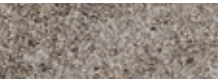
LITECH

 G001 crema
 G002 moka
 G003 pietra
 G004 grigio rigato



MARBLE

 28 calacatta
 184 crystal grey
 186 crystal brown
 180 emperador
 183 noir saint laurent
 187 verde lepanto
 182 rosso lepanto
 181 nero marquina

MATT MARBLE

 198 calacatta opaco
 194 crystal grey opaco
 191 nero marquina opaco
 185 crystal white opaco

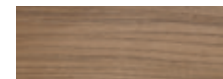
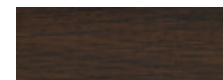
WOOD

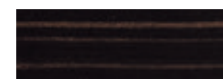
 711 rovere
 15 noce
 19 rovere termotrattato
 27 rovere nero
 710 tinto ebano

SAHARA WOOD

 17 noce sahara
 20 rovere termotrattato sahara



TAIGA WOOD

 701 rovere taiga
 700 tinto ebano taiga

MELAMINE

 07 melaminico olmo
 09 melaminico rovere grigio
 25 melaminico larice carbone

INTERNAL MELAMINE

 UB07 mel. cuoio grigio
 UB09 mel. cuoio brown

Collection designed by Giuseppe Bavuso.

GRÜN BECK

RIMADESIO - WIEN . AT

interior architects | design brand stores

Margaretenstraße 93 | A-1050 Wien
<https://rimadesio-wien.at>
+43 1 306 35 41
rimadesio@gruenbeck.co.at

RIMADESIO SPA
Via Furlanelli 96
20833 Giussano (MB) Italy
T +39 0362 3171
rimadesio@rimadesio.it

MILANO FLAGSHIP STORE
Via Visconti di Modrone 26
20122 Milano Italy
T +39 02 76280708
milano@rimadesio.it

LONDON FLAGSHIP STORE
83-85, Wigmore street
1WU 1DL London
T +44 2074 862193
london@rimadesio.co.uk

NEW YORK FLAGSHIP STORE
102 Madison Ave
New York, NY 10016
T +1 917 388 2650
usa@rimadesio.us

www.rimadesio.it



Follow us on Instagram, Facebook, LinkedIn,
WeChat, Weibo, Little Red Book.

Art direction and graphic project: Juma
Photo: Federico Cedrone, Santi Caleca
Technical photo: F2 Fotografia
Styling: Studiopepe; Patrizia Cantarella with Rossella Ballabio;
Martina Lucatelli with Martina Dalla Bona;
Simona Silenzi Studio; Gaia Marchesini and Giordano Sarno.

Thanks to: 101 Copenhagen, Afolki, Ames, Amini Carpets, aponteboretti, Arnolfo di Cambio, Astep, Atelier Interna, Azucena, B&B Italia, Bitossi Ceramiche, Carl Hansen & Søn, Caussa, Danese Milano, Dedar Milano, Dep Art Gallery, Egidio Milesi, Emil, Etel, Flexform, Flos, Fontana Arte, Gan Rugs, Gardeco, Ivano Redaelli, Kiasmo, Knoll International, Living Divani, Lorenz, Lorenzo Franceschinis, Louise Roe, Lumina, Mauro Bellucci, ESH Gallery Milano, Mmairo, Oluce, Phantom Hands, Project Audio / Audiogamma, Raawi, Raumgestalt, Santa&Cole, Scandola Marmi, Stelton, Schönhuber, Tacchini, Unurgent Argilla, Vitra, When Objects Work.

Artworks:
P. 105, 106-107 Mishka Henner, Antelope Valley Solar Ranch 1, 2018, Galleria Bianconi
P. 110-111 Kazuhito Nagasawa, The place where seeds have fallen, 2012, Officine Saffi

Films and print: Optima
Printed in Italy, 2024

AWARDS

1993	Siparium	Young & Design
2000	Zenit	Award KBB
2001	Zenit	selection Design Index ADI
2002	Siparium	Top100 Frames
2005	Graphis	selection Design Index ADI
2007	Vela	selection Design Index ADI
2008	Vela	mention XXI Premio Compasso d'Oro ADI
2015	Wind	winner Red Dot Award
2016	Cover	Best Furniture System AZ Award
2016	Alambra	selection Design Index ADI
2017	Sail	selection Design Index ADI
2017	Soho	Architectural products AZ awards
2017	Daimon	Interior Design Magazine Best of Year awards
2020	Modulor	People's Choice winner AZ Awards
2020	Modulor	Architectural Products Award of Merit AZ Awards
2020	Modulor	selection Design Index ADI
2021	Francis	selection Design Index ADI
2021	Modulor	LivingEtc Style Awards
2022	Maxi	selection Design Index ADI
2022	Aliante	finalist Interior's best of the Year awards
2022	Aliante	finalist A+Product awards
2023	Maxi	winner German Design Awards
2023	Radius	Architect's Newspaper's Best of Products Awards

PATENTED:

Radius, Aliante, Rialto, Maxi, Sail, Soho, Velaria, Stripe, Daimon, Graphis, Zen, Zen frame, Siparium, Moon, Vela, Luxor, Even, Aura, Spin, Link+, Planet, Flat, Alambra, Abacus living, Self, Cover, Zenit, Dress bold, Abacus.

REGISTERED TRADEMARKS:

Rimadesio, Colorsystem, Litech, Siparium, Velaria, Abacus.

