

COVER

Rimadesio

7 COVER SYSTEM, VANITY
10 COVER, 70 COVER FREESTANDING, 124 COVER OPEN
158 VANITY

rimadesio-wien.at

IT Il progetto Cover esprime la concezione Rimadesio dei sistemi di scansione degli interni realizzati sempre su misura, in grado di adattarsi ad ogni situazione architettonica, dall'ambito domestico a quello professionale. Cover è un sistema di ante battenti che possono essere utilizzate per chiudere gli ambienti dedicati alle cabine armadio o, in alternativa, per trasformare le nicchie in veri e propri armadi a muro. Il sistema infatti prevede una propria attrezzatura interna che non necessita di agganci a parete, perché si innesta direttamente sulla struttura portante delle ante.

DE Das Projekt Cover ist Ausdruck des Konzepts von Rimadesio für Einrichtungssysteme in Maßanfertigung, die sich an jede architektonische Situation anpassen lassen, vom privaten bis zum professionellen Bereich. Cover ist ein System aus Flügeltürblättern, mit denen Sie begehbare Kleiderschränke verschließen oder Nischen in echte Wandschränke verwandeln können. So verfügt das System über eine eigene Innenausstattung, die keine Wandhaken benötigt, da sie direkt an der tragenden Struktur der Türblätter befestigt wird.

FR Le projet Cover exprime le concept Rimadesio de systèmes intérieurs personnalisés, capable de répondre à toute type d'architecture, tant dans la sphère privée que professionnelle. Cover, c'est un système de portes battantes utilisables pour fermer les pièces dédiées aux dressings ou, en alternative, pour transformer les niches en véritables armoires encastrées. Ce système comprend en effet son propre équipement interne dépourvu de fixations muraux, car directement fixé à la structure porteuse des portes.

ES El proyecto Cover expresa el concepto de Rimadesio de sistemas de interiorismo personalizados que pueden adaptarse a cualquier situación arquitectónica, desde la doméstica hasta la profesional. Cover es un sistema de puertas batientes que permite cerrar las zonas dedicadas a los vestidores o, alternativamente, transformar las hornacinas en auténticos armarios empotrados. El sistema incluye un equipamiento interno propio que no requiere ganchos de pared, ya que se inserta directamente en la estructura portante de las puertas.

RU Проект Cover выражает концепцию Rimadesio по разработке индивидуальных систем дизайна интерьера, которые могут быть адаптированы к любой архитектурной ситуации: от бытовой до профессиональной. Cover — это система распашных дверей, которые можно использовать для закрытия гардеробных или для превращения ниш в настоящие встроенные шкафы. В системе предусмотрено собственное внутреннее оснащение, не требующее настенных крючков, поскольку крепится непосредственно к несущей конструкции дверей.

汉语 Cover 项目体现了 Rimadesio 的室内扫描系统的理念，居家或专业环境等各类建筑空间皆适用。Cover 为一款定制的铰链门系统，用于隔断步入式衣橱的空间，亦可将壁龛改造成真实的壁柜。由于该系统内部设有专门装置可直接与门片的支撑架构啮合，因此不需使用合页。

THE COVER PROJECT PERFECTLY ENCAPSULATES RIMADESIO'S CONCEPT OF SEAMLESS INTERIOR DESIGN; STORAGE ADAPTING TO ANY ARCHITECTURAL SITUATION, FROM DOMESTIC TO PROFESSIONAL SETTINGS. COVER IS A SYSTEM OF CUSTOM HINGED DOORS THAT CAN BE USED TO CLOSE ROOMS THUS CREATING WALK-IN CLOSETS OR, ALTERNATIVELY, TO TRANSFORM NICHES INTO PROPER BUILT-IN WARDROBES. THE SYSTEM IN FACT INCLUDES ITS OWN INTERNAL EQUIPMENT, FIXED DIRECTLY ONTO THE LOAD-BEARING STRUCTURE OF THE DOORS, WITHOUT THE NEED FOR WALL FIXINGS.

COVER SYSTEM

10 COVER, 70 COVER FREESTANDING, 124 COVER OPEN

COVER SYSTEM



CLOSING SYSTEM FEATURING GLASS, LITECH, FABRIC AND SYNTHETIC LEATHER HINGED DOORS. THE KEY FEATURE OF THE COVER PROJECT ARE THE UPRIGHTS, FIXED TO THE CEILING AND FLOOR AND ENCLOSING THE INVISIBLE HINGES OF THE DOORS AND THE EXCLUSIVE INTEGRATED INTERNAL LED LIGHTING SYSTEM. SHELVES AND DRAWER UNITS ARE FIXED TO THE UPRIGHTS USING AN INTERLOCKING SYSTEM, WITH INVISIBLE SCREWS, ALLOWING FOR A FREE AND EASILY CHANGEABLE PLACEMENT OVER TIME. THE DOORS ARE ALSO AVAILABLE IN THE SAHARA AND TAIGA WOOD FINISHINGS.

IT Sistema di chiusura attrezzato con ante battenti in vetro, Litech, tessuto e similpelle. Fulcro del progetto Cover sono i montanti, fissati a soffitto e a pavimento, che raccolgono i cardini invisibili delle ante e l'esclusivo sistema integrato di illuminazione interna a led. Mensole e cassettiere vengono fissate ai montanti con un sistema ad incastro, senza viti a vista, che consente una disposizione libera e modificabile nel tempo con estrema facilità. Le ante del sistema sono disponibili anche in finitura essenza sahara e taiga.

DE Verschlussystem mit Flügeltürblättern aus Glas, Litech, Stoff und Kunstleder. Das Herzstück des Cover-Projekts sind die an der Decke und am Boden befestigten Pfosten, die die unsichtbaren Scharniere der Türblätter und das einzigartige integrierte LED-Innenbeleuchtungssystem enthalten. Die Ablagen und Kommoden werden ohne sichtbare Schrauben mit einem Verriegelungssystem an den Pfosten befestigt, sodass sie frei angeordnet und im Laufe der Zeit leicht verändert werden können. Die Türblätter des Systems sind auch in den Holzausführungen Sahara und Taiga erhältlich.

FR Système de fermeture équipé de portes battantes en verre, Litech, tissu et similicuir. Le projet Cover repose avant tout sur ses montants, fixés au plafond et au sol, qui renferment les charnières invisibles des portes, aussi que le système exclusif d'éclairage interne à LED. Les étagères et les tiroirs sont fixés aux montants à travers d'un système d'emboîtement, sans vis apparentes, ce qui permet une disposition libre et modifiable, avec une extrême facilité. Les portes du système sont également disponibles dans les finitions en bois sahara et taiga.

ES Sistema de cierre equipado con puertas batientes de cristal, Litech, tela y simil cuero. La pieza central del proyecto Cover son los montantes, fijados al techo y al suelo, que sostienen las bisagras invisibles de las puertas y el exclusivo sistema de iluminación interior LED integrado. Los estantes y cajones se fijan a los montantes mediante un sistema de encaje, sin tornillos visibles, lo que permite una libre disposición que puede cambiarse con el tiempo con extrema facilidad. Las puertas del sistema también están disponibles en acabados de madera sahara y taiga.

RU Система запирания устанавливается на распашные дверцы из стекла, Litech, шпона, ткани и эко-кожи. Сердце проекта Cover-стойки, закрепленные к полу и потолку и удерживающие невидимые петли дверей и уникальную интегрированную светодиодную систему внутреннего освещения. Полки и ящики крепятся к стойкам с помощью скрытых крепежей, что позволяет свободно располагать их и легко изменять их положение при необходимости. Отделка дверей системы также доступна в дереве Sahara и Taiga.

汉语 闭合系统的铰链门板有玻璃、Litech岩板、布面和仿真皮革等材质可供选择。Cover 的设计重心为固定与天花板和地面两端的立柱，其包含门片的隐形铰链以及独特的集成式 LED 内部照明系统。层板和抽屉柜通过连锁系统固定于立柱上，无可见螺钉，并可随时自由更改空间分配，毫不费力。这套系统的门片亦有 Sahara 和 Taiga 的木质表面处理可供选择。

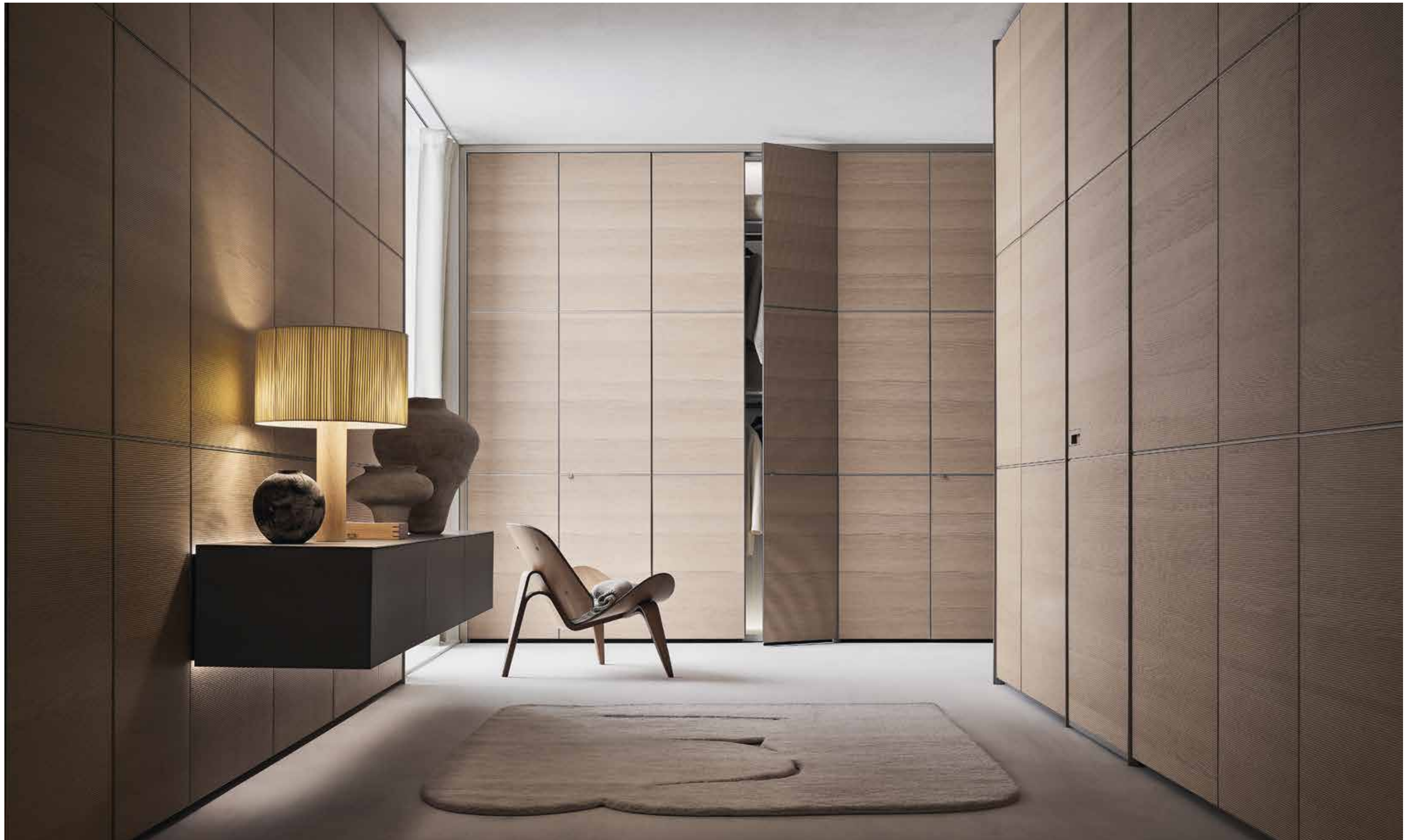



EN The Cover system is equipped with exclusive suspended drawer units, available in three heights and seven different configurations. The elegant and functional aluminium drawers are offered with transparent glass fronts, in all the Ecolorsystem aluminium finishings, covered with synthetic leather, and with open fronts. On the inside, the drawers are fully lined with fabric or synthetic leather. The glass top is available in two versions: transparent, to elegantly display the items in the drawer, or covered with synthetic leather to conceal the contents.

IT Il sistema Cover è dotato di esclusive cassettiere sospese disponibili in tre altezze e in sette configurazioni diverse. I cassetti in alluminio, eleganti e funzionali, sono previsti con frontale in vetro trasparente, in alluminio disponibile in tutti i colori Ecolorsystem, rivestito in similpelle e con frontale aperto. Internamente i cassetti sono completamente rivestiti in tessuto o in similpelle. Il top, sempre in vetro, è proposto in due versioni: trasparente, per un'elegante esposizione degli oggetti contenuti nel cassetto oppure rivestito in similpelle, per ottenere un effetto coprente.

DE Das Cover-System verfügt über exklusive, hängende Kommoden, die in drei Höhen und sieben verschiedenen Konfigurationen erhältlich sind. Die eleganten und funktionellen Schubladen aus Aluminium sind mit einer transparenten Glasfront, aus Aluminium in allen Ecolorsystem-Farben, mit Kunstleder bezogen und mit offener Front erhältlich. Im Inneren sind die Schubladen komplett mit Stoff oder Kunstleder gepolstert. Die Abdeckplatte, ebenfalls aus Glas, ist in zwei Ausführungen erhältlich: transparent, um die in der Schublade enthaltenen Gegenstände elegant zu präsentieren, oder mit Kunstleder bezogen, um einen blickdichten Effekt zu erzielen.

FR Le système Cover est équipé de tiroirs suspendus exclusifs, disponibles en trois hauteurs et sept configurations différentes. Élégants et fonctionnels, les tiroirs en aluminium sont dotés d'une façade en verre transparent, ou bien en aluminium disponible dans toutes les couleurs Ecolorsystem, recouvert de similicuir et avec façade ouverte. À l'intérieur, les tiroirs sont entièrement recouverts de tissu ou de similicuir. Le plateau, également en verre, est proposé en deux versions: transparent, pour une présentation élégante des objets contenus dans le tiroir, ou recouvert de similicuir, pour un effet couvrant.

ES El sistema Cover está equipado con exclusivos cajones suspendidos disponibles en tres alturas y en siete configuraciones diferentes. Los elegantes y funcionales cajones de aluminio cuentan con un frente de cristal transparente, de aluminio disponible en todos los colores Ecolorsystem, revestido en simil cuero y con el frontal abierto. Internamente los cajones están completamente revestidos en tejido o simil cuero. La tapa, también de cristal, se propone en dos versiones: transparente, para una elegante exposición de los objetos que contiene el cajón, o revestida en simil cuero, para obtener un efecto cubriente.

RU Система Cover оснащена эксклюзивными подвесными ящиками, доступными в трех вариантах высоты и семи различных конфигурациях. Элегантные и функциональные алюминиевые ящики предлагаются со следующими фасадами: прозрачными стеклянными, алюминиевыми, доступными во всех цветах Ecolorsystem, с обивкой из синтетической кожи и без фасада. Внутри ящики обиты тканью или искусственной кожей. Стеклянный верх доступен в двух вариантах: прозрачном — для элегантной демонстрации предметов, находящихся в ящике, или обтянутым искусственной кожей — для создания непрозрачного эффекта.

汉语 Cover 系统中也包含独特的悬挂式抽屉柜,有三种高度和七种配置可供选择。典雅实用的抽屉以铝合金打造,前板能够做成开放式,亦有透明玻璃、Ecolorsystem 所有色彩的铝合金材质或以仿真皮革包覆可供选择。抽屉内部皆全部采用布面或仿真皮革包覆。台面皆为玻璃材质,有两种款式可供选择:可优雅地展示柜中陈列物品的透明款,或是具不透明效果的仿真皮革款。

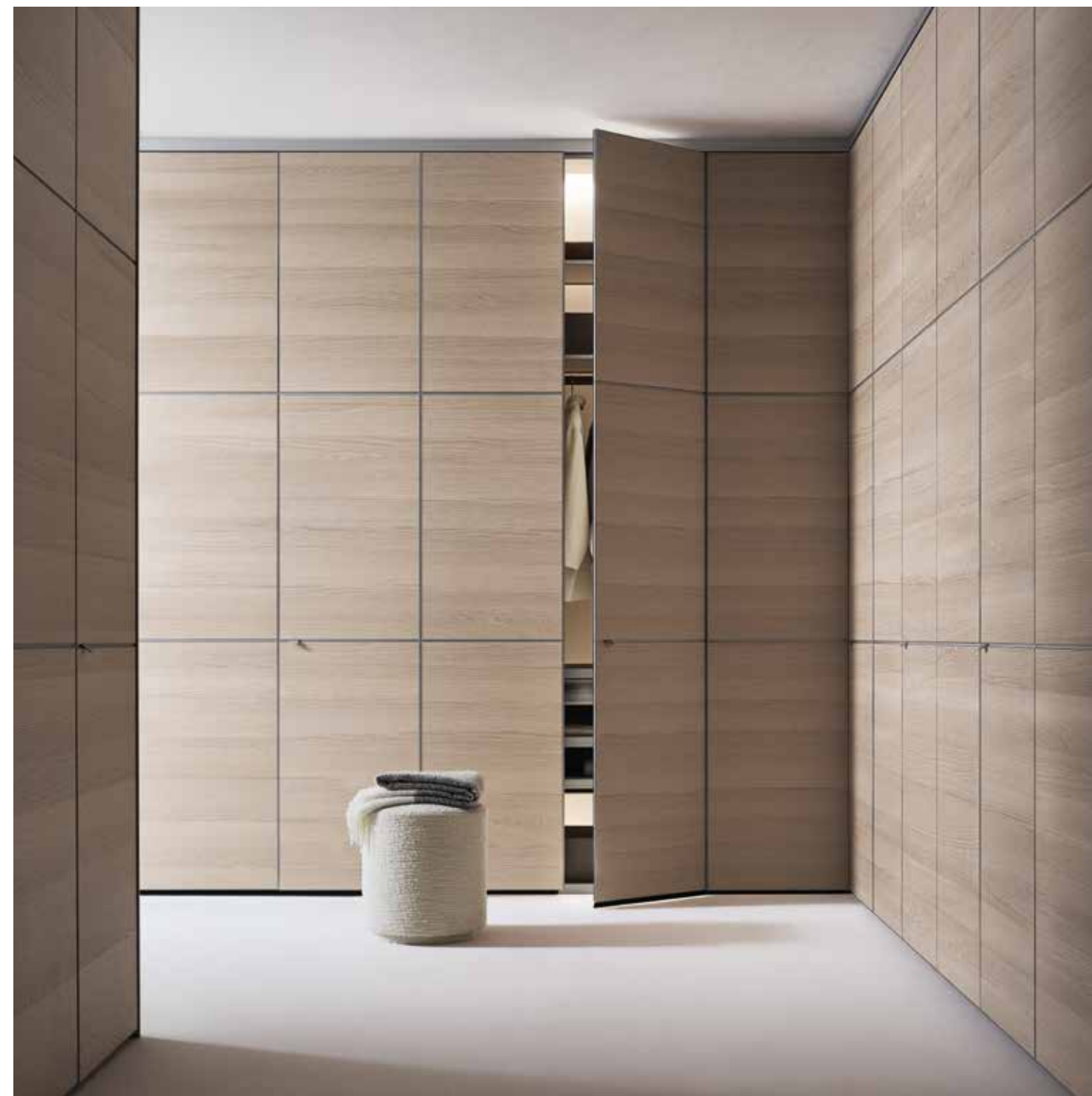

Structure: 304 platino
Doors: 701 rovere taiga
Glass drawer front and top: 67 riflettente chiaro

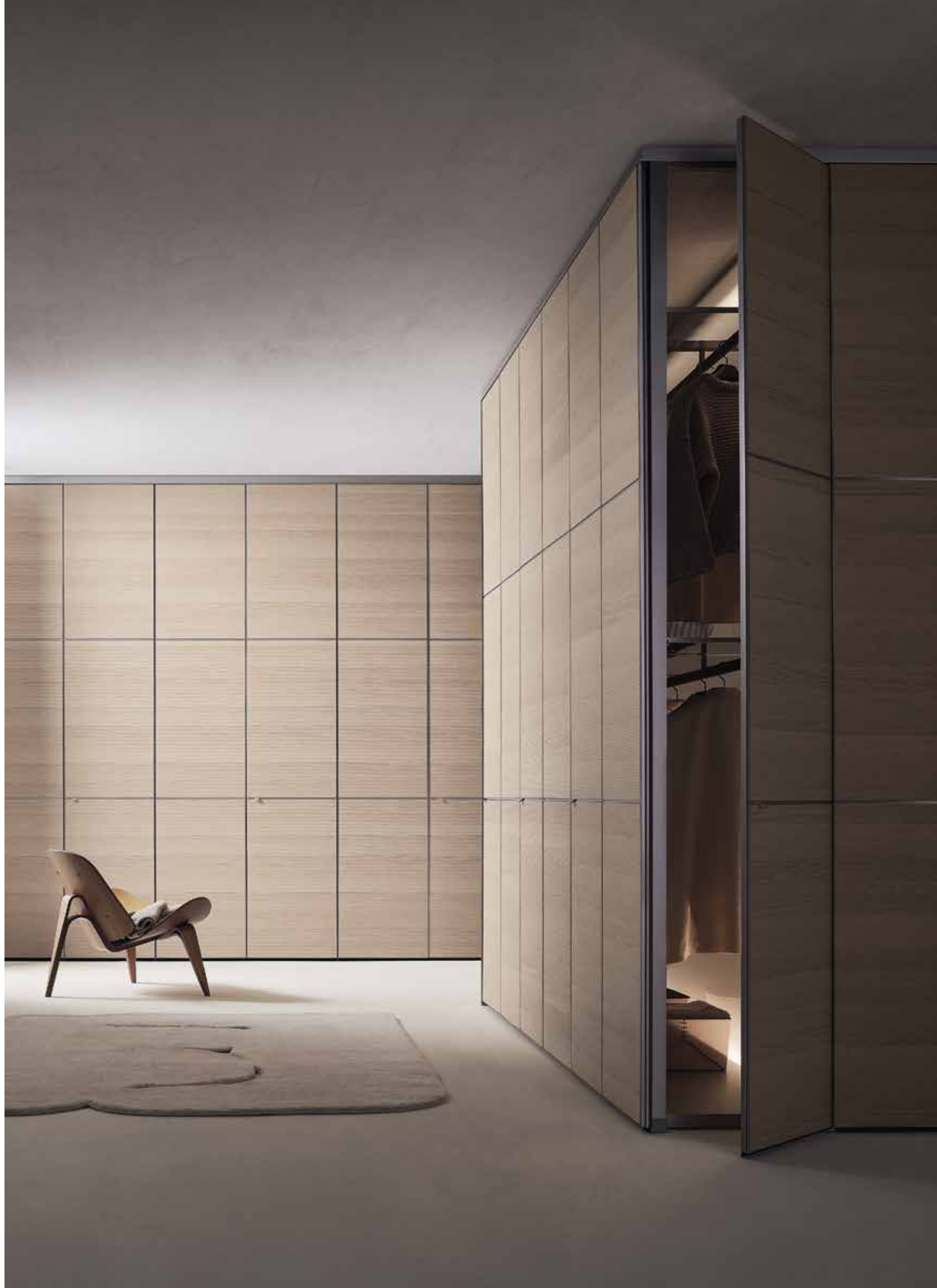







Structure and handle: 83 piombo
Doors: 127 piombo opaco, 63 grigio trasparente
Synthetic leather accessories: 160 miele
Shelves: 63 grigio trasparente

In this photo
Double sided display unit: Altair
Door: Radius

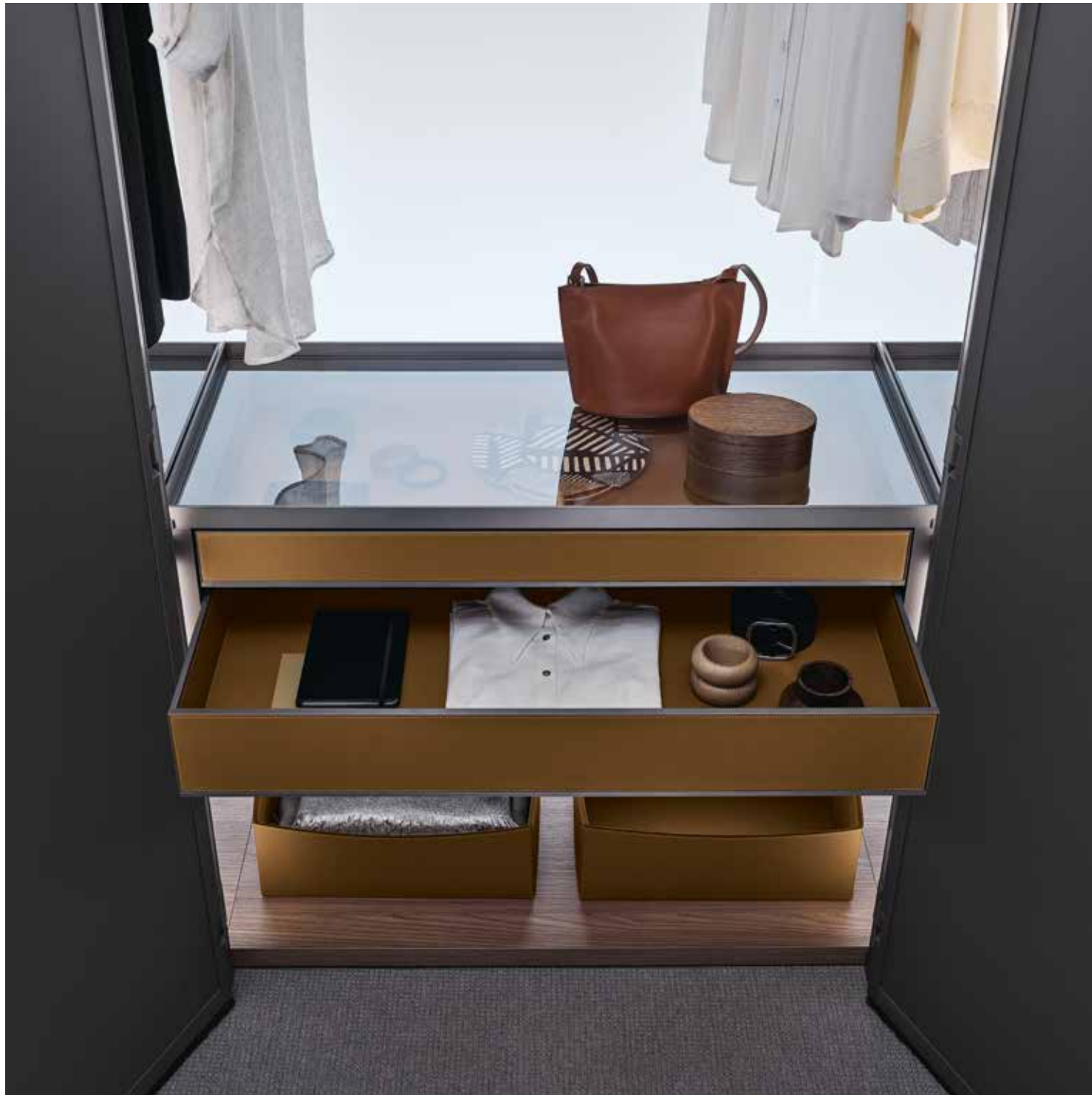



Structure and handle: 83 piombo
Glass doors: 127 piombo opaco
Synthetic leather accessories: 160 miele
Shelves: 07 melaminico olmo





EN Cover is a system of hinged doors that can be used to close rooms to create walk-in closets or, alternatively, to transform niches into proper built-in wardrobes. The hinged doors, with aluminium structure and cladding in transparent or lacquered glass, Litech, wood, synthetic leather and fabric, are equipped with die-cast Zamak handles with fixed latches or lock with key.

IT Cover è un sistema di ante battenti che possono essere utilizzate per chiudere gli ambienti dedicati alle cabine armadio o, in alternativa, per trasformare le nicchie in veri e propri armadi a muro. Le ante con apertura battente, con struttura in alluminio e rivestimento in vetro laccato o trasparente, Litech, essenza, similpelle e tessuto, sono dotate di maniglie in pressofusione di zama con nottolino fisso o con serratura e chiave.

DE Cover ist ein System aus Flügeltürblättern, mit denen Sie begehbare Kleiderschränke verschließen oder Nischen in echte Wandschränke verwandeln können. Die Flügeltürblätter mit einem Rahmen aus stranggepresstem Aluminium, Fronten aus lackiertem oder Transparentem Glas, Litech, Holz, Kunstleder oder Stoff sind mit Druckgussgriffen aus Zamak mit fester Sperrklinke oder mit Schloss und Schlüssel ausgestattet.

FR Cover est un système de portes battantes utilisables pour fermer les pièces dédiées aux dressings ou, en alternative, pour transformer les niches en véritables armoires encastrées. Les portes à ouverture battante, avec structure en aluminium et façade en verre laqué ou transparent, Litech, bois, similcuir et tissu, sont équipées de poignées en zamak moulé sous pression avec verrou fixe ou serrure et clé.

ES Cover es un sistema de puertas batientes que permite cerrar las zonas dedicadas a los vestidores o, alternativamente, transformar nichos en auténticos armarios empotrados. Las puertas de apertura batiente, con estructura de aluminio y frontal en vidrio lacado o transparente, Litech, madera, simil cuero y tejido, están equipadas con tiradores de zamak fundido a presión con condena fija o con cerradura y llave.

RU Cover- это система распашных дверей, которые можно использовать для закрывания гардеробных или для превращения ниш в настоящие встроенные шкафы. Распашные двери со структурой из алюминия и облицовкой из крашеного или прозрачного стекла, шпона, Litech, эко-кожи или ткани, оснащены ручками из алюминиевого сплава с простым магнитом или замком с ключом.

汉语 Cover 为一款铰链门系统, 用于隔断步入式衣橱的空间, 或将壁龛改造成真实的壁柜。铰链门开启系统搭配挤出铝合金结构、单层玻璃、4 毫米厚的Litech岩板, 木材或布面, 以上皆附有压铸成型的锌合金固定插销或门锁。

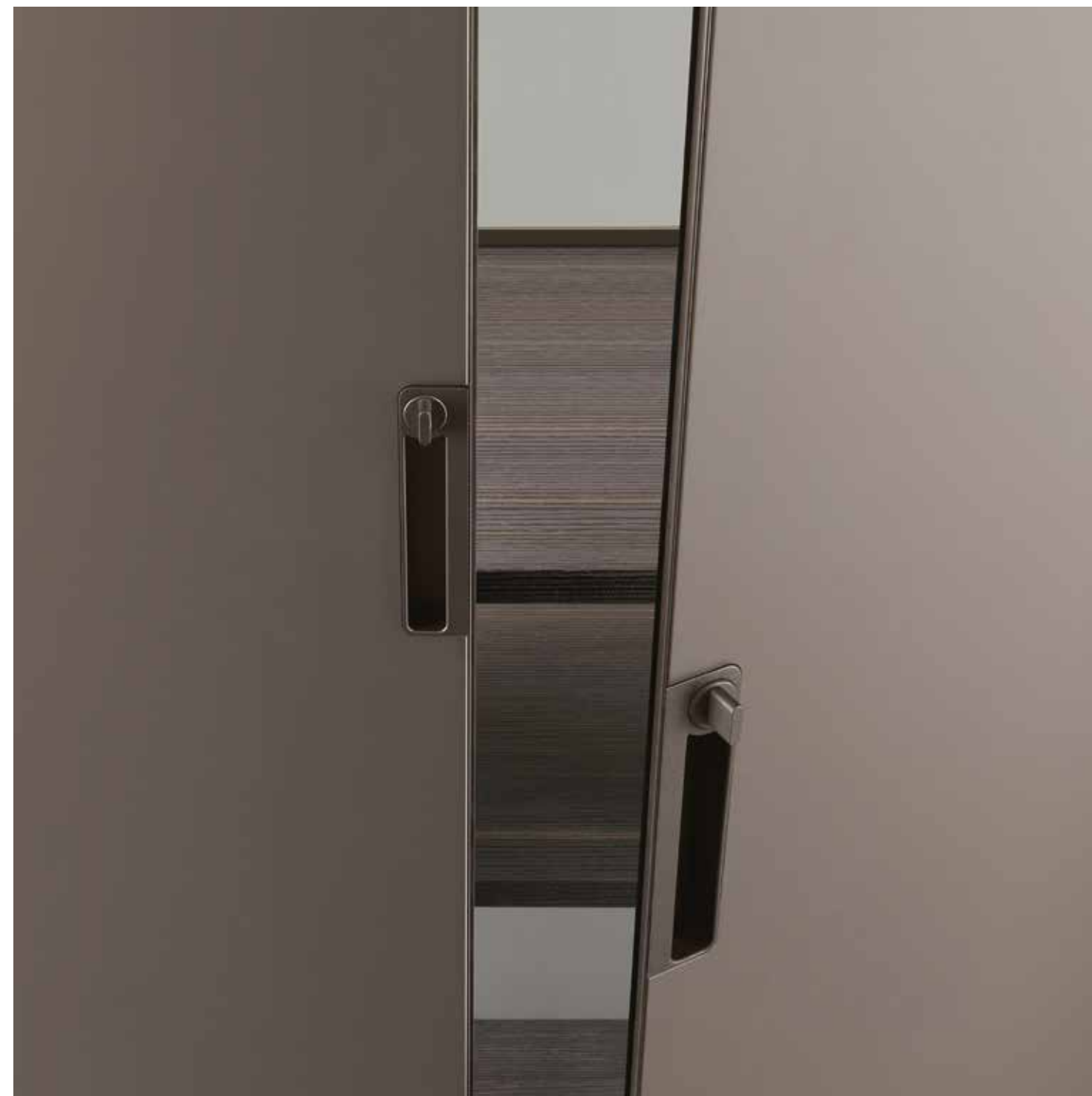



Structure and handle: 303 bronzo
Lux fabric doors: T051 salvia
Shelves: 63 grigio trasparente
Synthetic leather accessories: 153 castoro

In this photo
Wall panelling system: Modulor
Coffee table: Planet

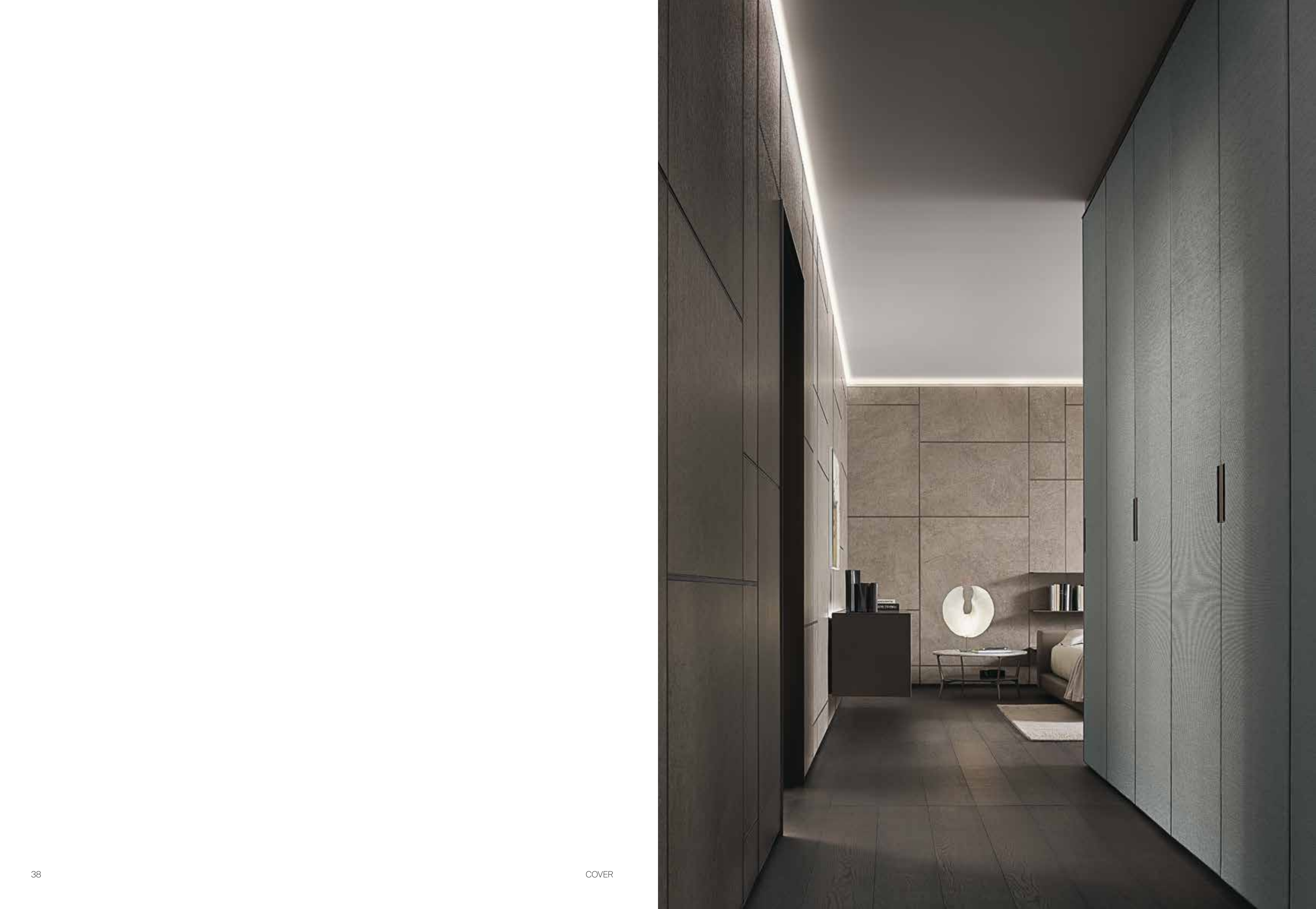

EN The fabric-covered Cover doors are available in three different styles: material, lux and a tech fire resistant version, ideal for hotels, retail and contracts. The fabric version is also available with sound-absorbing features thanks to a micro-perforated aluminium support and a honeycomb cardboard panel inside the door.

IT Le ante di Cover con rivestimento in tessuto sono disponibili in tre diverse tipologie: material, lux e nella versione tech resistente al fuoco (fire resistant) ideale per l'hotellerie, il retail e il contract. La versione in tessuto è disponibile anche con caratteristiche fonoassorbenti grazie ad un supporto in alluminio microforato e ad un pannello in cartone alveolare posto all'interno dell'anta.

DE Die stoffbespannten Türblätter der Linie Cover sind in drei verschiedenen Ausführungen erhältlich: Material, Lux und die feuerfeste Tech-Version, die ideal für den Hotel-, Einzelhandels- und Objektbereich ist. Die Stoffversion ist dank eines mikroperforierten Aluminiumträgers und einer Wabenkartonplatte auf der Innenseite der Tür auch mit schallabsorbierenden Eigenschaften erhältlich.

FR Les portes Cover avec revêtement en tissu sont disponibles en trois versions: material, lux et tech qui résiste au feu, idéale pour les hôtels, les magasins et les collectivités. La version en tissu est également disponible avec des caractéristiques phoniques, grâce à un support en aluminium micro-perforé et un panneau en carton/nid d'abeille placé à l'intérieur de la porte.

ES Las puertas con revestimiento tejido de Cover están disponibles en tres tipos diferentes: material, lux y tech resistente al fuego, ideal para los sectores hotelero, tiendas y contract. La versión tejido también está disponible con características fonoabsorbentes gracias a un soporte de aluminio microperforado y a un panel de cartón alveolar en el interior de la puerta.

RU Двери Cover с тканевой обивкой представлены в трех вариантах: material, lux и огнестойкая версия tech — идеально подходящая для гостиничного, торгового и коммерческого секторов. Исполнение с использованием ткани также обладает звукопоглощающими свойствами благодаря микроперфорированной алюминиевой основе и панели из сотового картона на внутренней стороне двери.

汉语 Cover 的门扇面板有三种饰面可供选择：Material、Lux 和科技防火型布料，这些面料是酒店、零售和商务空间的理想选择。门片内层的微孔铝板和蜂窝纸板层赋予布面版本的门扇具有吸音的功能。



Structure and handle: 303 bronzo
Lux fabric doors: T051 salvia
Shelves: 63 grigio trasparente
Synthetic leather accessories: 153 castoro

In this photo
Wall panelling system: Modulor

EN The internal accessories are fixed to the structural uprights, taking the weight off the back: they are therefore suspended away from the rear wall, with no visible holes or screws, ensuring a clean look and the possibility to add or remove accessories over time. The rear and side space allows air to circulate naturally inside the closet, enabling optimal ventilation of the clothes.

IT Gli accessori interni non appoggiano nella parte posteriore e sono fissati al montante strutturale: in questo modo risultano sospesi e staccati dalla parete posteriore, senza fori o viti a vista, garantendo la massima pulizia e la possibilità di aggiungere o togliere accessori nel tempo. Lo spazio posteriore e laterale assicura una circolazione naturale dell'aria interna all'armadio, per consentire una ventilazione ottimale degli abiti.

DE Die internen Zubehörteile liegen nicht auf der Rückseite auf, sondern sind an der strukturellen Stütze befestigt: Auf diese Weise werden sie ohne sichtbare Löcher oder Schrauben an der Rückwand aufgehängt und abgenommen, was maximale Sauberkeit und die Möglichkeit garantiert, im Laufe der Zeit Zubehör hinzuzufügen oder zu entfernen. Der Freiraum an der Rückseite und an den Seiten sorgt für eine natürliche Luftzirkulation im Inneren des Schrankes und damit für eine optimale Belüftung der Kleidung.

FR Les accessoires internes ne reposent pas sur la partie arrière et sont fixés au montant structurel: ils sont ainsi suspendus et détachés du mur, sans trous ni vis visibles, en garantissant une esthétique impeccable et la possibilité d'ajouter ou de retirer des accessoires au fil du temps. L'espace arrière et latéral assure une circulation naturelle de l'air à l'intérieur du dressing, pour permettre une aération optimale des vêtements.

ES Los accesorios internos no se apoyan en la parte trasera y se fijan al montante estructural: de esta forma quedan suspendidos y desprendidos de la pared trasera, sin agujeros ni tornillos visibles, garantizando la máxima limpieza y la posibilidad de añadir o quitar accesorios con el tiempo. El espacio trasero y lateral asegura la circulación natural del aire dentro del armario, para permitir una ventilación óptima de la ropa.

RU Внутреннее оснащение не крепится на заднюю стенку, а крепится к несущей стойке: таким образом, Оно висит, оторванное от задней стенки, без видимых отверстий и винтов, гарантируя максимальную чистоту и возможность добавления или демонтажа Начинки с течением времени. Свободное сзади и сбоку пространство обеспечивает естественную циркуляцию воздуха внутри шкафа для оптимального проветривания одежды.

汉语 内部配件不依附于柜体后侧，而是固定于结构立柱上：该配件悬挂于后板上，亦可拆卸下来，无需钻孔和可见螺钉，创造极致简洁性以及随时调整配件数量的可能性。后方和侧面的空间使柜内空气自然对流，确保衣物最佳的通风条件。





Structure: 303 bronzo
Wooden doors: 700 tinto ebano taiga
Glass doors: 67 riflettente chiaro
Shelves: 63 grigio trasparente

EN Cover is a complete system created for the night area, but it extends its use to the living area, thanks to the clear glass doors, which act as display cases, and the bottle shelves. The optional horizontal crosspieces align perfectly with the wooden doors to create a flawless aesthetic and allow for maximum storage customisation.

IT Cover è un sistema completo nato per la zona notte, ma estende il suo utilizzo al living, grazie alle ante in vetro trasparente, che fungono da vetrine, e ai ripiani portabottiglie. Sono disponibili traversini orizzontali opzionali per il perfetto allineamento estetico con le ante in legno in ottica di massima personalizzazione dei contenitori del sistema.

DE Cover ist ein komplettes System, das für den Schlafbereich geschaffen wurde, aber dank der transparenten Türblätter aus Glas, die als Vitrinen fungieren, und der Flaschenregale auch im Wohnbereich eingesetzt werden kann. Für eine perfekte ästhetische Anpassung an die Holztürblätter sind optionale horizontale Querhölzer erhältlich, um die Behälter des Systems maximal zu individualisieren.

FR Cover est un système complet créé pour l'espace nuit, mais dont l'utilisation peut être étendue à l'espace jour, grâce aux portes en verre transparent, qui font de vitrines, et aux étagères porte-bouteilles. Des traverses horizontales sont disponibles en option pour un alignement esthétique parfait avec les portes en bois et ce, pour personnaliser au maximum les rangements du système.

ES Cover es un sistema completo creado para la zona de noche, pero amplía su uso a la zona de día, gracias a las puertas de cristal transparente, que actúan como vitrinas, y a los estantes portabotellas. Hay disponibles travesaños horizontales opcionales para una alineación estética perfecta con las puertas de madera, para una personalización máxima de los contenedores del sistema.

RU Cover — это комплексная система, созданная для спальни зоны, но распространяющая свое действие и на гостиную, благодаря прозрачным стеклянным дверцам, служащим витринами, и полкам для бутылок. Опционально двери можно заказать с горизонтальными перемычками для идеального эстетического сочетания со шпонированными дверями, что позволяет максимально индивидуализировать систему хранения.

汉语 Cover 是一套十分完整的卧室系统, 以透明玻璃打造的门扇延伸至客厅空间, 能够当做展示柜和酒瓶层板架使用。有水平横挡可供选配, 用于创造出与木制门扇完美对齐的美感, 并实现系统收纳柜的最大程度的定制化。



Structure: 303 bronzo
Wooden doors: 700 tinto ebano taiga
Glass doors: 67 riflettente chiaro
Shelves: 63 grigio trasparente



Structure: 303 bronzo
Wooden doors: 700 tinto ebano taiga
Glass doors: 67 riflettente chiaro
Shelves: 63 grigio trasparente
Floor base and bottle rack: 07 melaminico olmo

In this photo
Storage system: Cover open





EN Taiga is a textured glass with a 3D effect. The surface is wavy with a horizontal texture and a velvety mat effect to the touch. This lacquered glass is available in 29 colours (22 Ecoloursystem and 7 metalized finishings), designed to stand the test of time because they are applied on the internal surface of the glass, shielded from stains, dust and humidity. The door is available with a magnetic closure and the handle integrated into the structure.

IT Taiga è un vetro materico ad effetto 3D. La superficie è ondulata a trama orizzontale con effetto opaco vellutato al tatto. È un vetro laccato disponibile in 29 colori (22 Ecoloursystem e 7 metallizzati), inalterabili nel tempo perché applicati sulla superficie interna del vetro, al sicuro da macchie, polvere e umidità. L'anta è disponibile con chiusura magnetica e con la maniglia integrata nel traverso.

DE Taiga ist ein strukturiertes Glas mit einem 3D-Effekt. Die Oberfläche ist geriffelt und horizontal strukturiert und fühlt sich samtig matt an. Dieses lackierte Glas ist in 29 Farben erhältlich (22 Ecoloursystem und 7 Metallic-Farben), die im Laufe der Zeit unveränderlich sind, da sie auf der Innenseite des Glases aufgetragen werden und somit vor Flecken, Staub und Feuchtigkeit geschützt sind. Das Türblatt ist mit einem Magnetschloss und mit einem in die Querstange integrierten Griff erhältlich.

FR Taiga est un verre texturé effet 3D. Sa surface est ondulée avec une texture horizontale et un effet mat et velouté au toucher. Il s'agit d'un verre laqué disponible en 29 couleurs (22 Ecoloursystem et 7 métallisées), inaltérables car appliquées sur la surface interne du verre, à l'abri des taches, de la poussière et de l'humidité. La porte est disponible avec fermeture magnétique et avec la poignée intégrée à la traverse.

ES Taiga es un material de vidrio con efecto 3D. La superficie es ondulada con una textura horizontal con un efecto mate aterciopelado al tacto. Es un vidrio lacado disponible en 29 colores (22 Ecoloursystem y 7 metalizados), inalterable en el tiempo porque se aplica sobre la superficie interna del vidrio, a salvo de manchas, polvo y humedad. La puerta está disponible con cierre magnético y con tirador integrado en el travesaño.

RU Taiga — это текстурированное стекло с 3D-эффектом с Рифленой по горизонтали поверхностью, и бархатистая на ощупь. Это лакированное стекло доступно в 29 цветах (22 Ecoloursystem и 7 металлизированных), не меняющихся со временем, поскольку Краска нанесена на внутреннюю поверхность стекла, защищенную от воздействия пятен, пыли и влаги. Дверь Имеет магнитный притвор и ручку, встроенную в перемычку.

汉语 Taiga 为一款具有 3D 效果和带有纹理的玻璃。表面为横织波浪状，具有丝绒般的哑光效果。这款漆面玻璃有 29 种颜色可供选择 (22 种 Ecoloursystem 色彩和 7 种金属色)，这些玻璃色料涂于玻璃内层表面，不易褪色，抗污渍、灰尘和湿度。门扇搭配磁吸式关闭装置和嵌入横边的把手。



Structure and handle: 304 platino
Doors: 821 grigio scuro taiga
Drawer fronts and accessories
in synthetic leather: 154 argilla



Structure and handle: 83 piombo
Doors and sides: 00 trasparente
Shelves: 63 grigio trasparente
Drawer units and bottle rack:
25 melaminico larice carbone

In this photo
Sliding doors: Graphis Plus





Structure: 83 piombo
Doors: 00 trasparente
Drawer unit and bottle rack: 25 melaminico larice carbone
Drawer top and interior in synthetic leather: 154 argilla



TECHNICAL DESCRIPTION

EN The Cover project renews the design concept of the niche or wardrobe, transforming the doors in the one and only structural element necessary to fix the internal equipment. Like all Rimadesio systems, Cover boasts numerous exclusive features: for example, the uprights are equipped with a new invisible system allowing for adjustment in three directions, which ensures perfect levelling of the doors, even in large installations. Cover system accessories include floor bases, shelves, clothes-hanger rods, pull out shelves and drawer units. All the elements are fixed directly to the uprights, without visible screws, and the layout can be easily modified over time.

IT Il progetto Cover rinnova la concezione progettuale della nicchia o dell'armadio a muro, trasformando le ante nell'unico elemento strutturale necessario a cui agganciare l'attrezzatura interna. Come tutti i sistemi Rimadesio, Cover è dotato di una serie di accorgimenti esclusivi, come i montanti muniti di un inedito sistema di regolazione invisibile in tre direzioni, che consente una perfetta messa in bolla delle ante, anche con composizioni di grandi dimensioni. L'attrezzatura completa del sistema Cover prevede basamenti, mensole, aste portabiti, ripiani estraibili e cassettiere. Tutti gli elementi vengono fissati ai montanti con un sistema ad incastro, senza viti a vista, e la disposizione può essere modificata e variata nel tempo con estrema facilità.

DE Das Projekt erneuert das Konzept der Nische oder den Schrankraum. Die Türen sind die einzige strukturelle Elemente wo, die Innenausstattung fixiert wird. Wie alle Systeme von Rimadesio ist Cover mit einer Reihe exklusiver Merkmale ausgestattet, wie z. B. Pfosten, die mit einem noch nie dagewesenen, unsichtbaren Verstellsystem in drei Richtungen versehen sind, das eine perfekte Nivellierung der Türblätter ermöglicht, auch bei großformatigen Zusammenstellungen. Die Ausstattung des Systems Cover bietet Basisboden, Fachboden, Kleiderstange ausziehbarer Fachboden und Schubladenelemente an. Alle Elemente sind an den Pfosten befestigt mit einem Verbindungssystem ohne sichtbare Schrauben und die Verstellung kann im Laufe der Zeit leicht verändert werden.

FR Le projet Cover renouvelle la conception d'équiper une niche ou un placard en transformant les portes dans le seul élément structurel nécessaire auquel fixer tous les accessoires à l'intérieur. Comme tous les systèmes Rimadesio, Cover est doté d'une série de caractéristiques exclusives, comme les montants équipés d'un tout nouveau système de réglage invisible dans trois directions, pour un nivellement parfait des portes, même avec de grandes dimensions. L'équipement complet du système Cover comprend bases au sol, étagères, tiges porte-manteaux, étagères extractibles et bloc tiroirs. Tous les éléments sont fixés aux montants avec un système à encastrement sans vis visibles et la disposition peut être facilement modifiée ensuite.

ES El proyecto Cover renueva la concepción de proyecto de los espacios pequeños o del armario contra pared, transformando las hojas en el único elemento estructural necesario a los cuales enganchar el equipo interior. Como todos los sistemas Rimadesio, Cover está dotado de una serie de características exclusivas, como los montantes dotados de un nuevo sistema de regulación invisible en tres direcciones, que permite una perfecta nivelación de las puertas, incluso con grandes composiciones. El equipo completo del sistema Cover proporciona soportes, estantes, barras colgantes, estantes extraíbles y cajoneras. Todos los elementos se fijan a los montantes con un sistema a encaje, sin tornillos a vista, y la disposición se puede modificar y variar en el tiempo con facilidad extrema.

RU Проект Cover обновляет концепцию дизайна ниши или встроенного шкафа, превращая двери в единственный необходимый конструктивный элемент, к которому можно прикрепить внутреннее оснащение. Как и все системы Rimadesio, Cover оснащена рядом уникальных функций: стойки, оборудованные беспрецедентной системой невидимой регулировки в трех направлениях, которая позволяет идеально выровнять двери даже при больших композициях. В комплект системы Cover входят Основания, полки, штанги для одежды, выдвижные Аксессуары и тумбы. Полки и ящики крепятся к стойкам с помощью системы блокировки при помощи скрытых винтов, что позволяет свободно располагать их и легко изменять их положение.

汉语 Cover 创新了壁龛或墙面衣柜的设计概念, 将门扇变成唯一的必要结构元素, 并在其之上挂设内部配件。如同所有 Rimadesio 的系统, Cover 具备一系列独特功能, 如: 配备新型三向隐形调节系统的立柱, 即使需要配置大型尺寸的组合柜也能将多个门扇的位置保持水平一致。Cover 系统的全套设备包含底座、层板、衣杆、抽拉式层板和抽屉柜。所有部件皆通过连锁系统固定在立柱上, 无可见螺钉, 并可随时自由更改空间分配, 毫不费力。

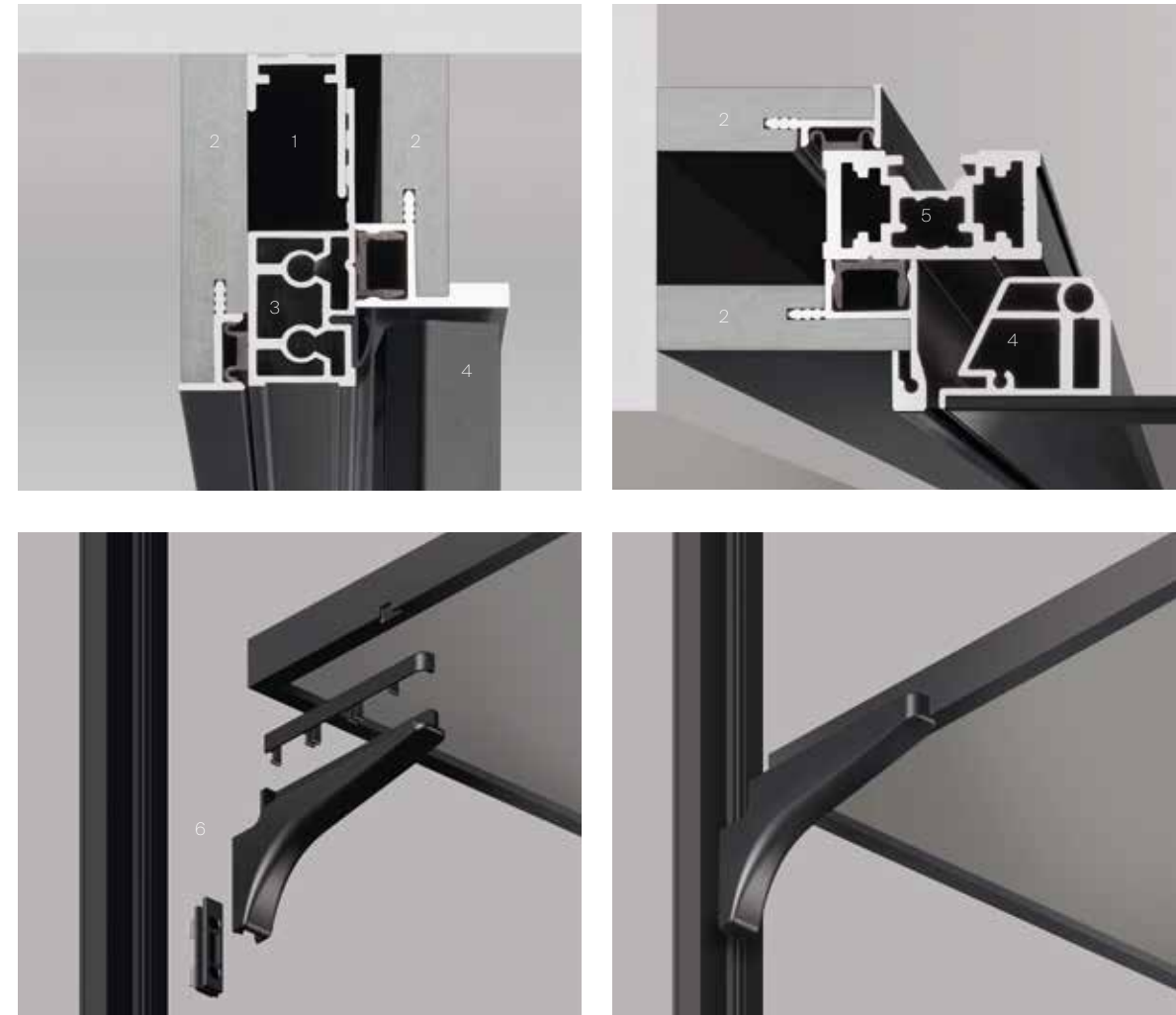

1. Ceiling adjusting profile in extruded aluminium. It allows a perfect levelling of the upright and to compensate any possible unevenness of the ceiling.
2. Fillers with supporting profile in extruded aluminium and adjustment filler in lacquered mdf perfectly adaptable to the opening. Unique concealed nylon fixing system.
3. Structural crosspiece in extruded aluminium, equipped with closing magnets and perimetric joint in pvc, which allows a soft and silent closing.
4. Panel door with extruded aluminium structure and single tempered front glass thickness 4 mm. Closing joint in silicone rubber.
5. Extruded aluminium structural upright, which can be equipped with optional led lighting system. Patented recess hinges which allow a micrometric adjusting of the door height.
6. Accessories fixing system: all the elements are fixed directly to the uprights, without visible screws, and the layout can be easily modified over time.

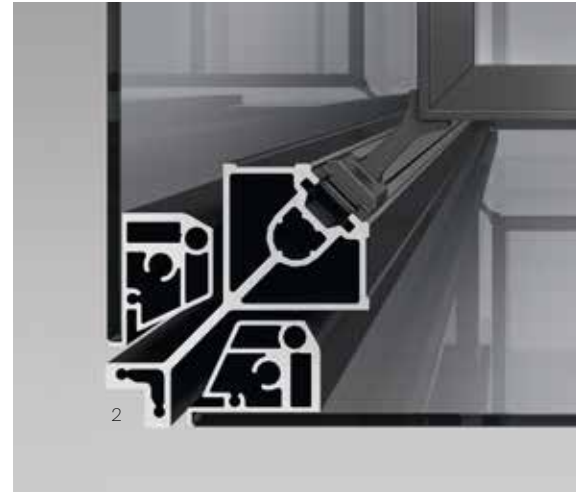
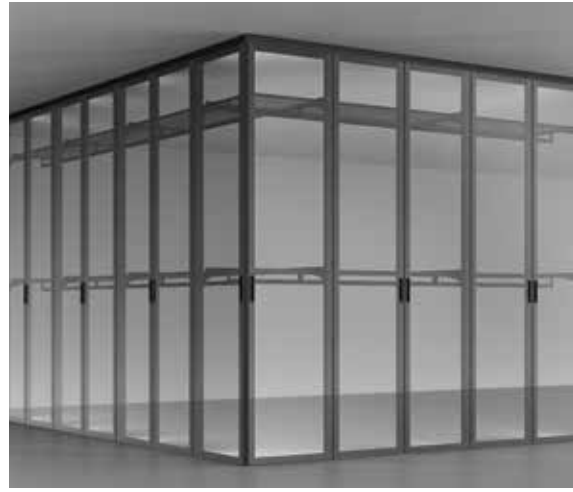
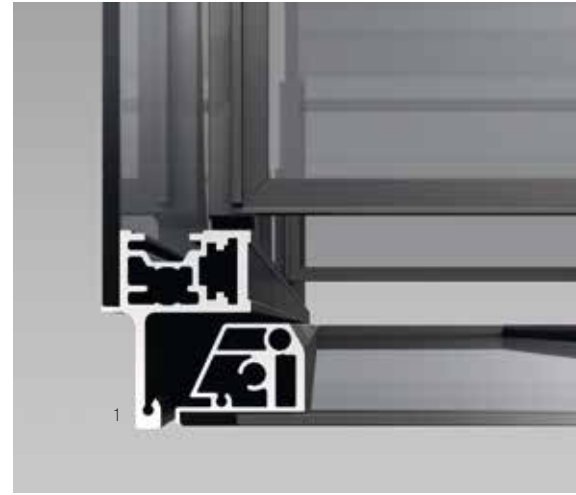
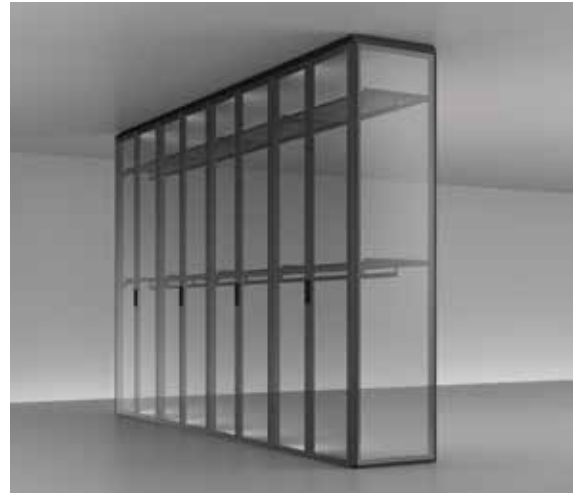

1. Aluminium structural upright in 83 piombo
2. Black pvc joint
3. Swing door with 83 piombo aluminium structure and 127 piombo opaco glass cladding
4. Lacquered mdf fillers in 83 piombo
5. Aluminium structural upright in 304 platino
6. Grey pvc joint
7. Swing door with 304 platino aluminium structure and 137 platino opaco glass cladding
8. Lacquered mdf fillers in 304 platino
9. Swing door with 317 grigio artico aluminium structure and 600 grigio artico opaco glass cladding
10. Lacquered mdf fillers in 317 grigio artico
11. Swing door with 308 pepe aluminium structure and 141 pepe opaco glass cladding
12. Lacquered mdf fillers in 308 pepe

TECHNICAL DESCRIPTION

EN The final side (1), made entirely from glass and aluminium, is the natural conclusion to the Cover system. The floor, wall and ceiling adjustment systems allow for perfect installation even if the walls are irregular. Available in two depths, the storage is always customisable in terms of height. The upright for the external corner compositions (2) is equipped with an invisible three-direction adjustment system to guarantee that the doors are perfectly level.

IT Il fianco finale (1), interamente realizzato in vetro e alluminio, è il naturale completamento del programma Cover. Le regolazioni a pavimento, a parete e a soffitto consentono una perfetta installazione anche in presenza di pareti irregolari. Disponibile in due profondità, è sempre realizzato su misura in altezza. Il montante per composizioni ad angolo esterno (2) è munito di un sistema di regolazione invisibile in tre direzioni che consente una perfetta messa in bolla delle ante.

DE Die abschließende Seitenwand (1), die vollständig aus Glas und Aluminium besteht, ist der natürliche Abschluss des Cover-Programms. Boden-, Wand- und Deckenanpassungen ermöglichen eine perfekte Installation auch an unebenen Wänden. Das System ist in zwei Tiefen erhältlich und wird in der Höhe immer in Maßanfertigung hergestellt. Der Pfosten für Außenekkompositionen (2) ist mit einem unsichtbaren Verstellsystem in drei Richtungen ausgestattet, mit dem die Türblätter perfekt nivelliert werden können.

FR Le panneau terminal (1), entièrement réalisé en verre et aluminium, vient compléter naturellement le programme Cover. Les réglages au sol, aux murs et au plafond permettent d'ajuster parfaitement l'installation, même en présence de murs irréguliers. Disponible en deux profondeurs, il est toujours réalisé sur mesure en hauteur. Le montant pour compositions en angle extérieur (2) est équipé d'un système de réglage invisible dans trois directions, pour un nivellement parfait des portes.

ES El lateral final (1), íntegramente realizado en vidrio y aluminio, es el complemento natural del programa Cover. Las regulaciones de suelo, pared y techo permiten una perfecta instalación incluso en presencia de paredes irregulares. Disponible en dos profundidades, siempre se fabrica con la altura a medida. El montante para composiciones de esquinas exteriores (2) está dotado de un sistema de regulación invisible en tres direcciones que permite una perfecta nivelación de las puertas.

RU Внешняя боковая панель (1), выполненная полностью из стекла и алюминия— естественное завершение программы Cover. Регулировка относительно пола, стены и потолка обеспечивает идеальную установку даже при неровных стенах. Выпускается в двух вариантах по глубине; высота всегда индивидуальна. Стойка для внешних угловых композиций (2) оснащена невидимой системой регулировки в трех направлениях, что позволяет идеально выровнять двери.

双语 端板 (1)·完全以玻璃和铝合金打造·为 Cover 方案自然地增强完整性。即使墙面凹凸不平·通过地面·墙面和天花板的调节组件亦能完美安装。有两种深度可供选择·高度皆按照尺寸定制。外转角型组合柜的立柱 (2) 结合三向隐形调节系统·能多个门片的位置保持水平一致。

Hinged doors

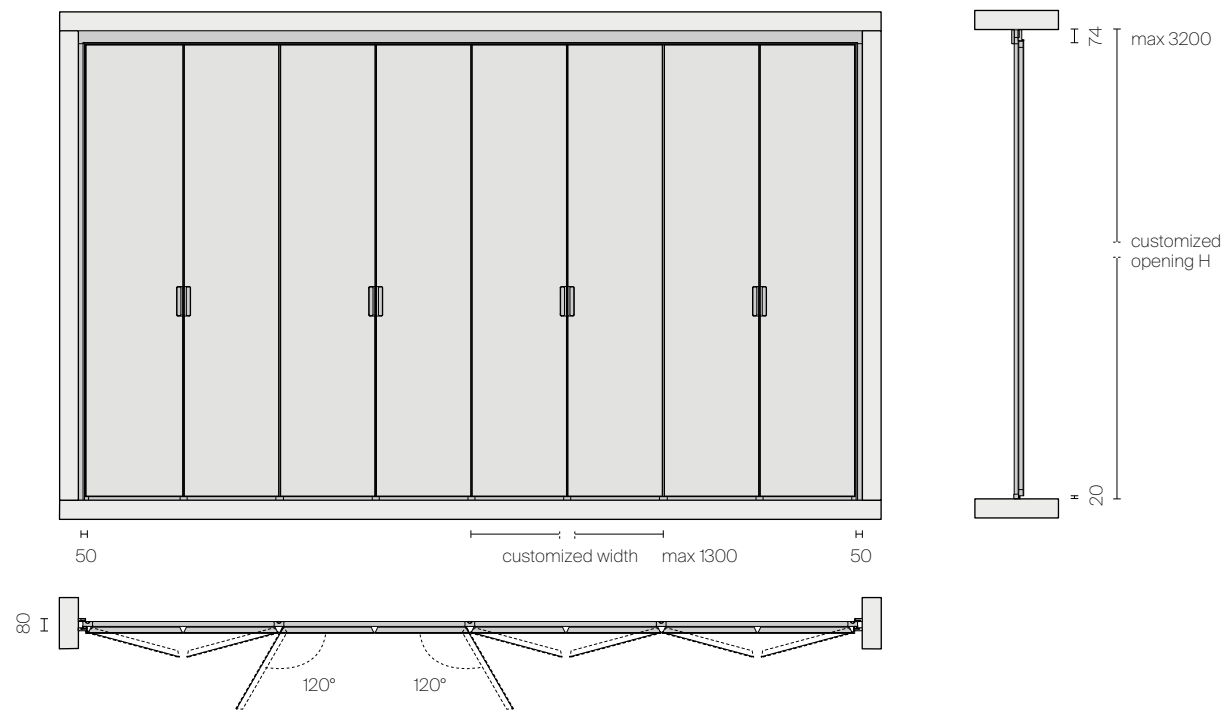

Hinged doors with internal equipment

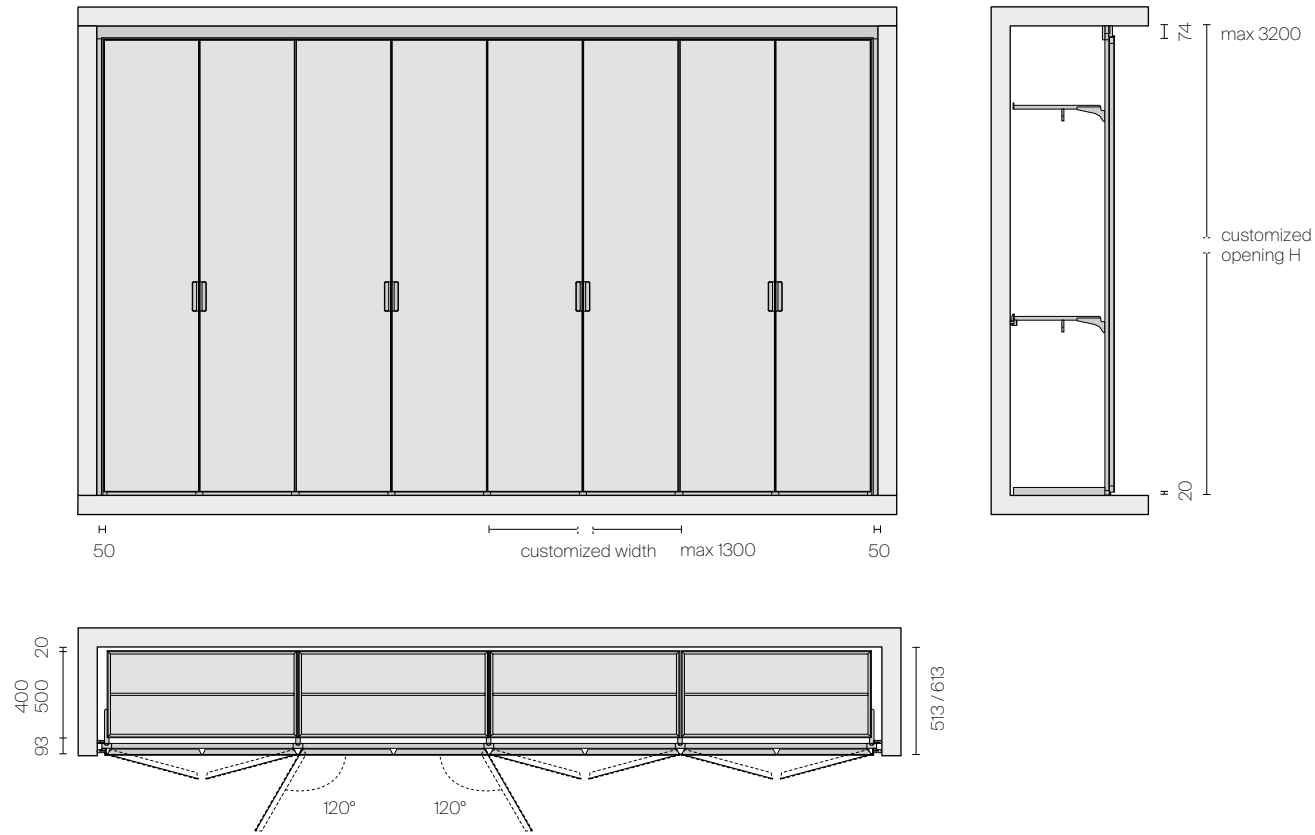

Wall composition

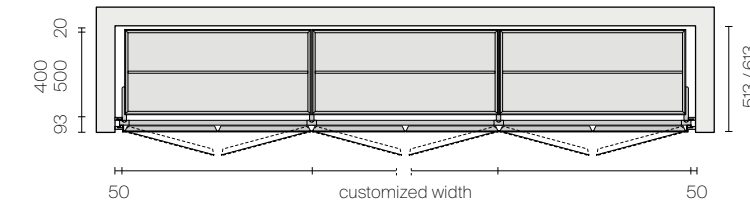

Linear composition with terminal panels

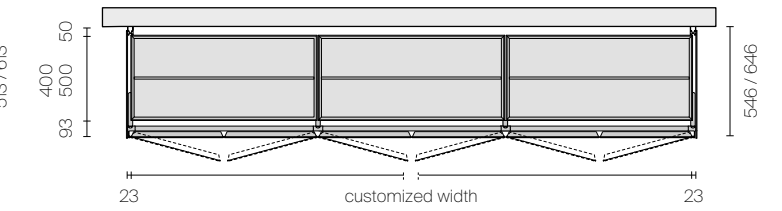

Corner composition

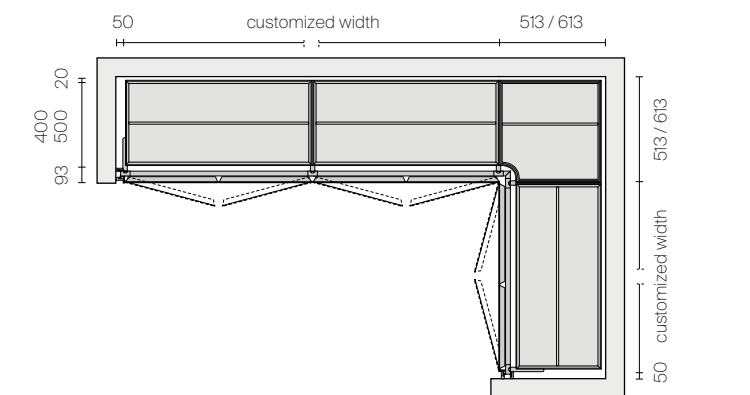

Composition with external corner

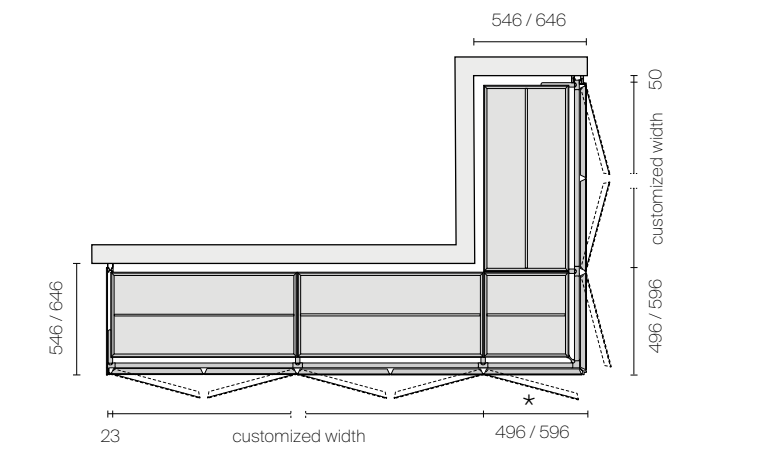

* side door available without handle

C-shaped composition

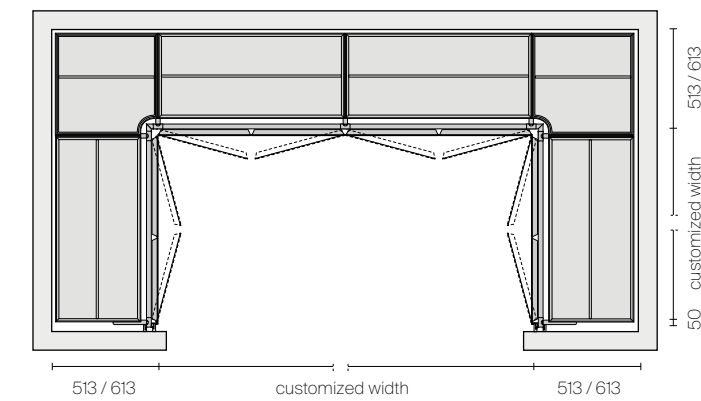

Equipped niche

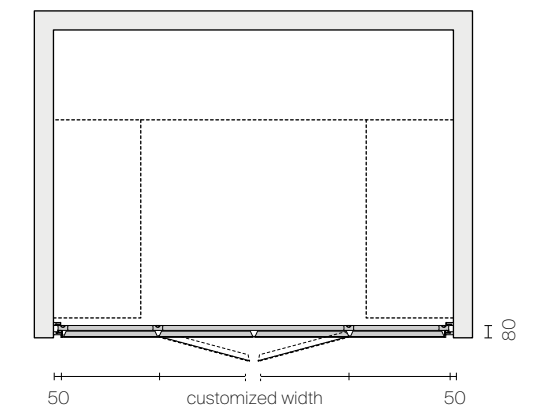

DOORS

Glass swing door



Double finished swing door

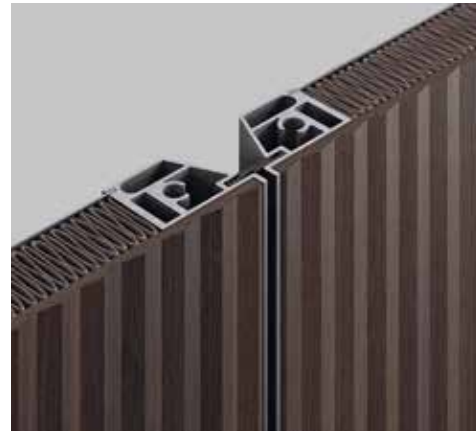

Sound-absorbing swing door with fabric cladding



DOORS AESTHETICAL TYPOLOGIES

Full height single glass swing door

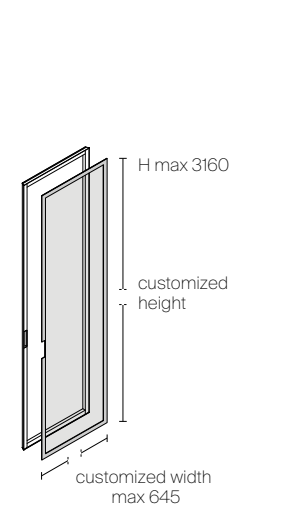

Single glass swing door with optional decorative crosspieces

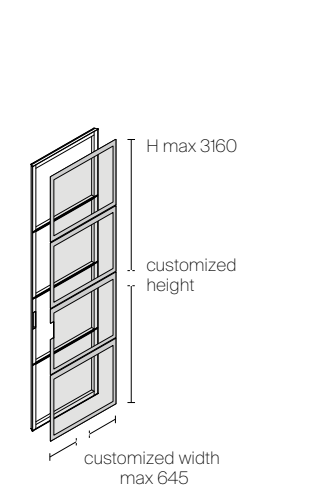

Full height double finished swing door

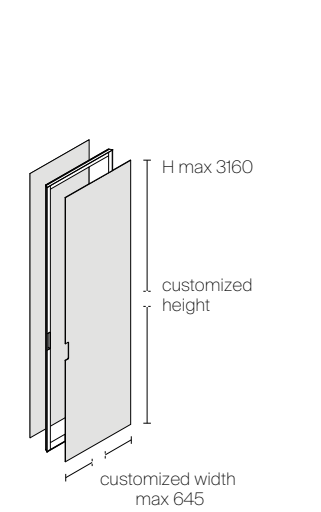

Double finished swing door with optional crosspieces

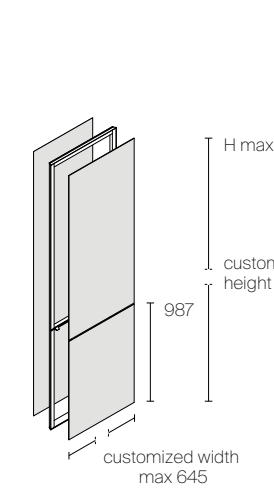

HANDLES



1



2



3

1. Handle 2013 in die-casting aluminium
2. Handle 2014F in die-casting aluminium with fixed lever tumbler / Handle 2014C with hook lock and key
3. Handle 2021 integrated in the crosspiece

STRUCTURAL ELEMENTS

Ceiling adjusting profile

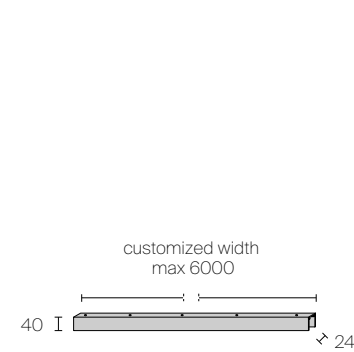

Structural crosspieces

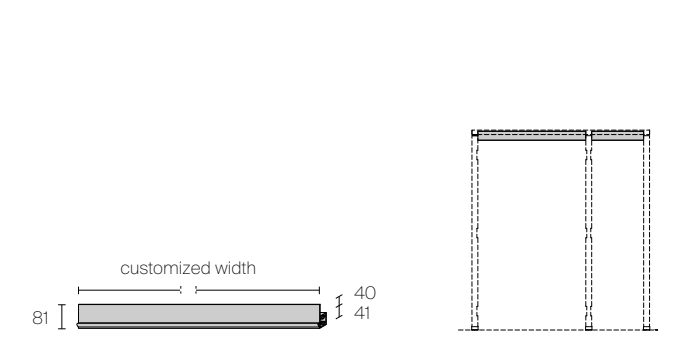

Structural upright

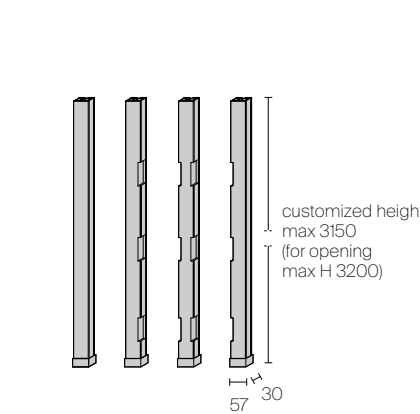

Structural upright for external corner

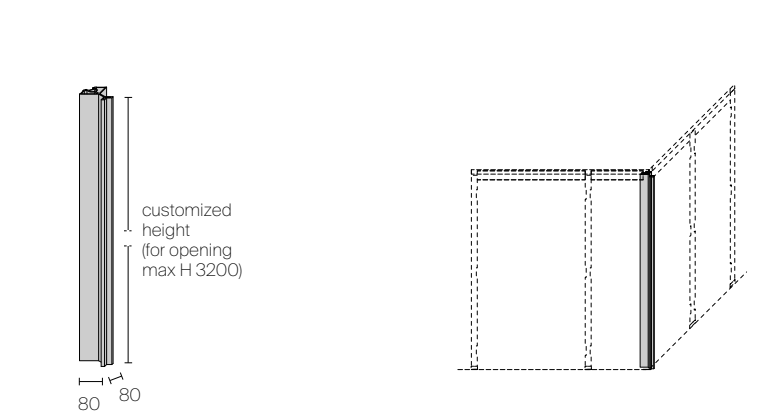

Front/back side filler

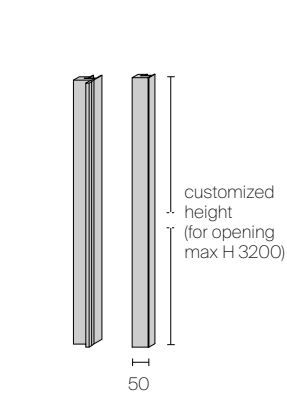

Upper front and back filler

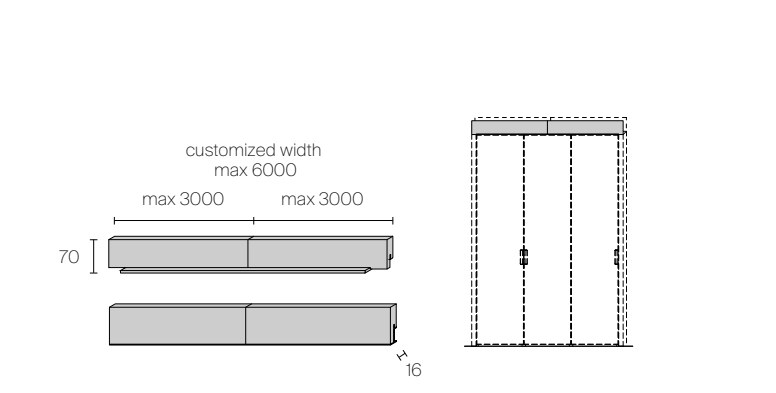

Linear floor base in lacquered wood or melamine

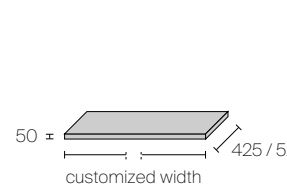

Corner floor base in lacquered wood or melamine

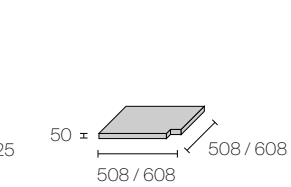

Floor base in lacquered wood or melamine for external corner

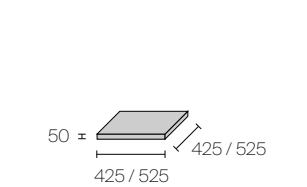

Terminal panel in tempered glass, Litech, fabric, synthetic leather, sahara and taiga wood

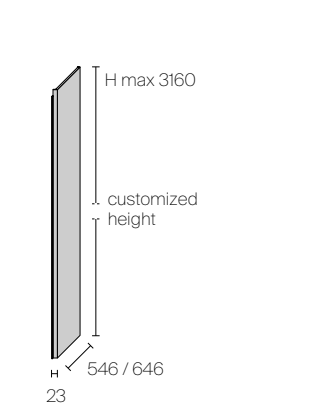

Structural uprights led lighting system

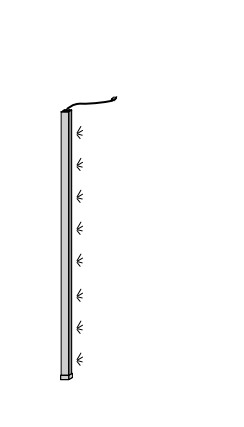



COVER FREESTANDING IS THE SELF-SUPPORTING VERSION OF THE COVER SYSTEM, THEREFORE EQUIPPED WITH SIDES AND BACK PANELS TO ALLOW THE DEFINITION OF ALWAYS CUSTOM MADE LINEAR OR CORNER COMPOSITIONS. THE PERFECT FINISHING OF THE BACK PANELS AND OF THE INSIDE OF THE DOORS MAKE COVER FREESTANDING AN IDEAL SYSTEM ALSO FOR NICHE SOLUTIONS AS WELL, COMPLETE OF INTEGRATED PASSAGES.

IT Cover freestanding è la versione autoportante del sistema Cover, dotato quindi di fianchi laterali e pannelli schienali per consentire la definizione di composizioni lineari o con angoli, sempre a misura. La perfetta finitura degli schienali e dell'interno delle ante rendono Cover freestanding un sistema ideale anche per soluzioni interparete, completo di passaggi integrati.

DE Cover freestanding ist die selbst- tragende Version des Cover Systems, das daher mit Seiten-teilen und Rückwänden aus- gestattet ist, um lineare oder eckige Kompositionen auf Maß zu definieren. Das perfekte Finish der Rückenlehnen und der Türinnenseiten macht Cover freestanding zu einem idealen System auch für Zwischenwand-lösungen mit integrierten Durch- gängen.

FR Cover freestanding est la version autoportante du système Cover, donc équipé de panneaux latéraux et de panneaux de fond pour permettre la définition de compositions linéaires ou en angle, toujours sur mesure. La finition parfaite des panneaux de fond et de l'intérieur des portes permettent à Cover de devenir un système idéal aussi pour les solutions entre mur, avec des passages intégrés.

ES Cover freestanding es la versión autoportante del sistema Cover, equipada por lo tanto de paneles laterales y paneles traseros para permitir la definición de composiciones lineales o en ángulo, siempre a medida. El perfecto acabado de los paneles traseros y del interior de las puertas hacen de Cover freestanding un sistema ideal también para soluciones entre paredes, completo de hueco de pasos.

RU Cover freestanding — это самонесущая версия системы Cover, оснащенная боковыми и задними панелями, позволяющими создавать линейные или угловые композиции, всегда точно по размеру. Безупречная отделка задних стенок и внутренней поверхности дверей делает отдельно стоящие шкафы Cover идеальной системой для разграничения пространства, в том числе с интегрированными проходами.

汉语 Cover freestanding 为 Cover 系统的独立式版本, 其侧板和背板能够打造出各式线性或转角式的组合方案, 皆按尺寸定制。由于背板和门扇内侧完美的表面处理, Cover freestanding 成为分隔空间解决方案的理想系统, 该系统设有集成通道。

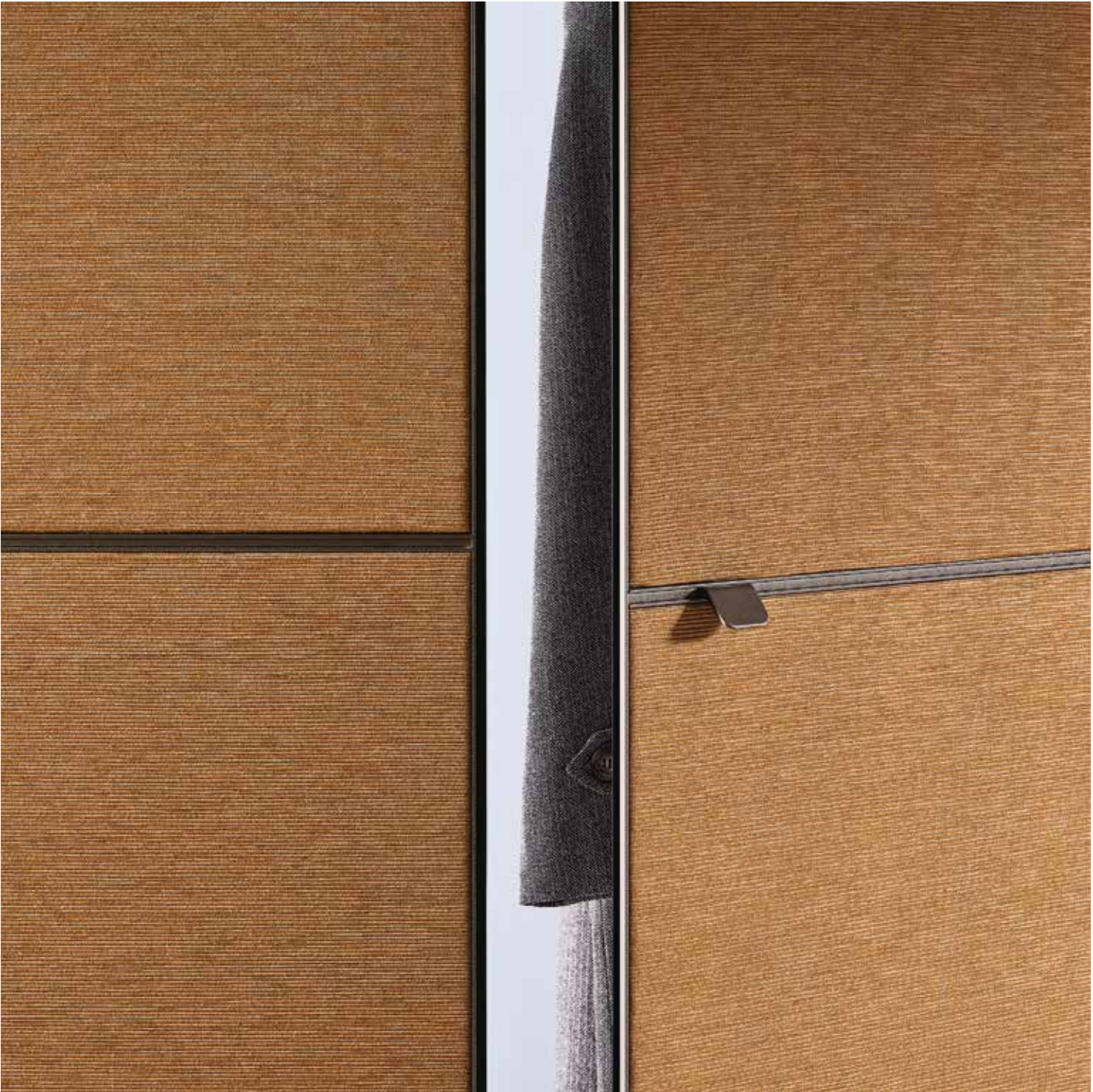







EN The front doors and side panels of the Cover and Cover freestanding systems are finished with different types of mesh, maglia and fibra glass, which feature interwoven metal threads that creates a three-dimensional texture. The ever-shifting reflections and semi-transparent elements vary depending on the light.

IT Le ante frontali e i fianchi di Cover e Cover freestanding sono esaltati da diverse tipologie di vetri rete, maglia e fibra, caratterizzati da un intreccio di fili metallici che crea una trama tridimensionale, dando vita a un gioco di riflessi e semi-trasparenze che varia a seconda della luce.

DE Die Front- und Seitentüren von Cover und Cover freestanding sind durch verschiedene Arten von Mesh, Gewebe und Fiberglas veredelt. Diese zeichnen sich durch ein Geflecht aus Metalldrähten aus, das ein dreidimensionales Gewebe erzeugt und ein Spiel aus Reflexionen und Halbtransparenzen schafft, das je nach Lichteinfall variiert.

FR Les portes avant et les côtés de Cover et Cover freestanding sont rehaussés par différents types de verres, mailles et fibres, caractérisés par un entrelacement de fils métalliques qui crée une texture tridimensionnelle, en donnant vie à un jeu de reflets et de semi-transparences qui varie en fonction de la lumière.

ES Las puertas frontales y laterales de Cover y el autoportante Cover están realzadas por distintos tipos de malla, rejilla y fibra de vidrio, caracterizados por un entrelazado de hilos metálicos que crea una trama tridimensional, creando un juego de reflejos y semitransparencias que varía en función de la luz.

RU Стекло фасадов и боковых панели Cover в версиях «в нишу» и «отдельностоящий» может быть с разными видами сеток, характеризующихся трехмерным переплетением металлической проволоки и создающих игру отражения и полупрозрачности, меняющиеся в зависимости от освещения.

汉语 Cover 和 Cover freestanding 的前门扇和侧边采用了网夹层、网格夹层和纤维夹层等不同种类的玻璃，其以金属丝线制成的三维织纹尤为特色：玻璃随着光线变化产生各种反射和半透明的效果。



Structure and handle: 303 bronzo
Doors and side panels: 08 fibra bronzo
Shelves: 65 bronzo trasparente
Synthetic leather accessories: 157 arena
Back panel: 04 acidato bronzo



Structure and handle: 303 bronzo
Doors and side panels: 08 fibra bronzo
Shelves: 65 bronzo trasparente
Synthetic leather accessories: 157 arena
Back panel: 04 acidato bronzo

In this photo
Storage system: Cover
Coffee table: Planet

EN The terminal side and the back panel, entirely made of glass and aluminium, are the natural completion of the Cover Freestanding system. This exclusive project is equipped with special extruded aluminium frames and internal equipment that can be positioned in complete freedom.

IT Il fianco finale e lo schienale interamente realizzati in vetro e alluminio sono il naturale completamento del programma Cover freestanding. Un progetto esclusivo, dotato di profili in alluminio estruso dedicati e di attrezzature interne posizionabili in totale libertà.

DE Die Abschlusseite und die Rückenlehne sind ganz aus Glas und Aluminium gefertigt und bilden die natürliche Ergänzung zum Cover-Programm freistehend. Ein exklusives Design mit speziellen stranggepressten Aluminiumprofilen und einer Innenausstattung, die völlig frei positioniert werden kann.

FR La panneau terminal et le fond sont entièrement réalisés en verre et en aluminium, et complètent naturellement le programme Cover freestanding. Un projet exclusif, avec des profilés en aluminium extrudé dédiés et des équipements internes positionnables en toute liberté.

ES El lateral y el fondo son totalmente de cristal y aluminio, y son el complemento natural del programa autoportante Cover. Un proyecto exclusivo, equipado con perfiles de aluminio extruido específicos y equipamiento interno que se puede colocar con total libertad.

RU Внешняя боковая панель, полностью выполненная из стекла и алюминия — естественное завершение программы Cover. Эксклюзивный дизайн со специальными профилями из экструдированного алюминия и внутренним оснащением, которое может быть размещено совершенно свободно.

汉语 端板和背板完全以玻璃和铝合金打造, 为 Cover freestanding 方案自然地增强完整性。这项独特设计方案的轮廓以挤出铝合金打造, 内部配件可完全自由任意放置。

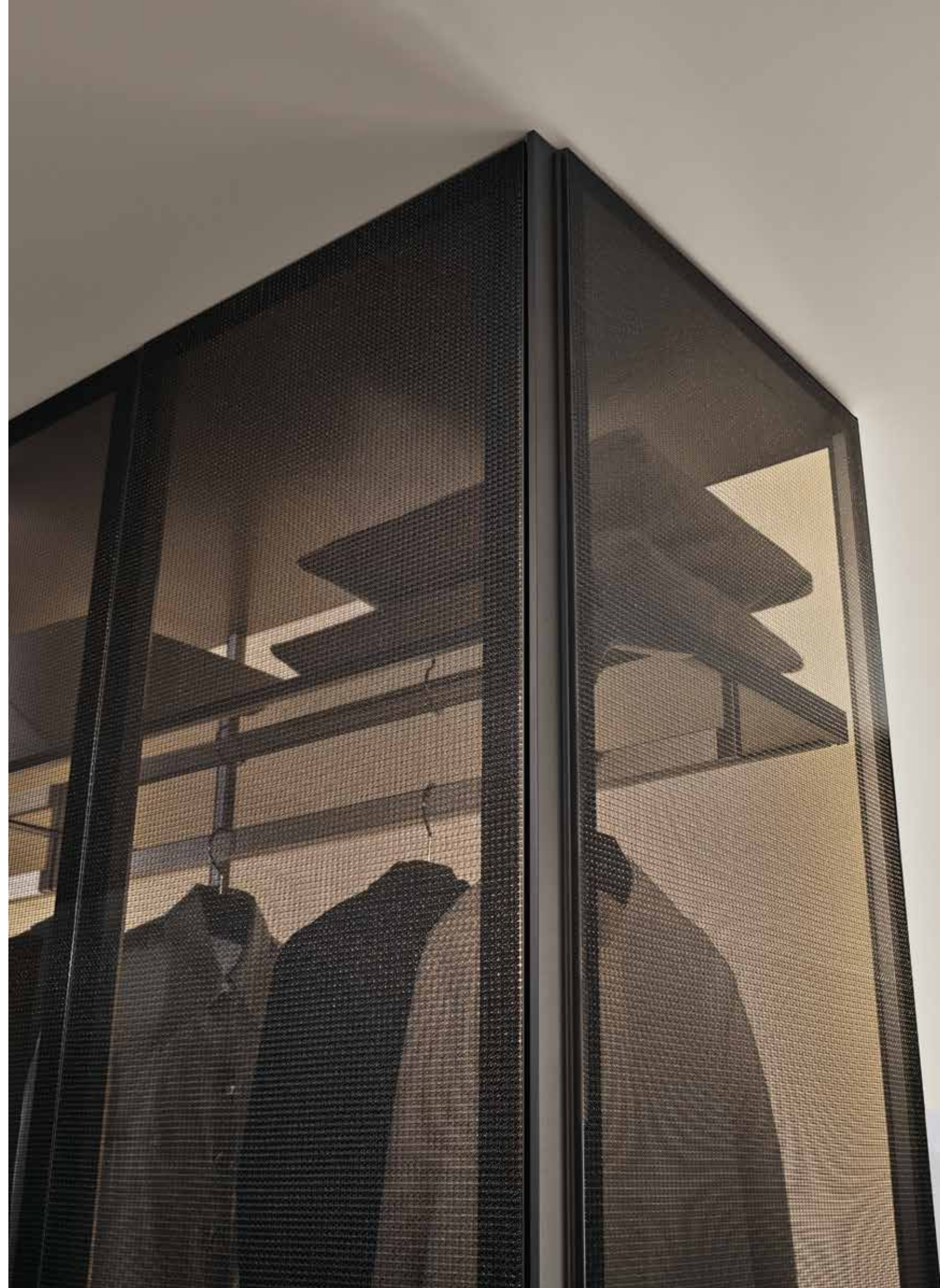



Structure and handle: 303 bronzo
Doors and side panels: 08 fibra bronzo
Shelves: 65 bronzo trasparente
Synthetic leather accessories: 157 arena
Back panel: 04 acidato bronzo

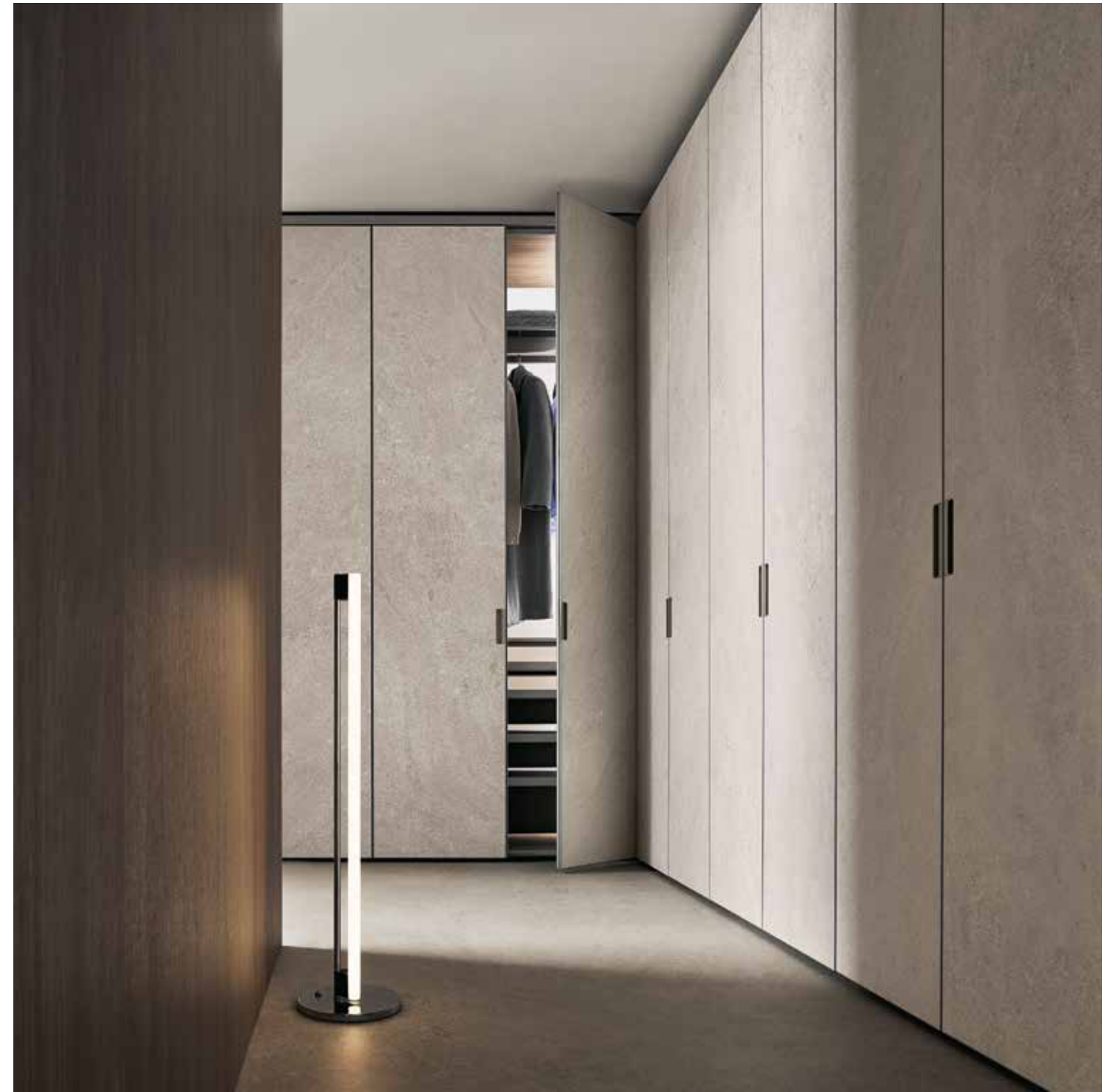

EN Refined finishings, trendy colours, flawless accessories: Cover freestanding is a 360° project in which each element helps to create a homogeneous, refined and elegant ensemble. The aluminium structure is available in six finishings (aluminium, nero, brown, piombo, platino and bronzo), while the doors are available in tempered glass in the glossy and matt versions of the Ecolorsystem range – diamante, sahara, taiga and reflex – and in all the transparent, etched, reflective, and mirrored glass options, in addition to the four Litech finishings, synthetic leather, fabric, sahara and taiga wood.

IT Le finiture ricercate, i colori di tendenza, la perfezione degli accessori: Cover freestanding è un progetto coordinato a 360° nel quale ogni elemento della composizione concorre alla definizione di un insieme omogeneo, raffinato, elegante. La struttura in alluminio è disponibile in sei finiture (alluminio, nero, brown, piombo, platino e bronzo), le ante in vetro temperato nelle tonalità lucide e opache della gamma Ecolorsystem, diamante, sahara, taiga, reflex e in tutti i vetri trasparenti, acidati, riflettenti, e specchio oltre alle 4 finiture Litech, similpelle, tessuto ed essenze sahara e taiga.

DE Die raffinierten Oberflächen, die trendigen Farben, die Perfektion der Accessoires: Cover freestanding ist ein rundum abgestimmtes Projekt, bei dem jedes Element der Komposition zur Definition eines homogenen, raffinierten und eleganten Ganzen beiträgt. Die Aluminiumstruktur ist in sechs Ausführungen erhältlich (Alluminium, Nero, Brown, Platino und Bronzo), die Türblätter aus gehärtetem Glas in den glänzenden und matten Farben der Ecolorsystem-Palette, Diamante, Sahara, Taiga, Reflex und in allen transparenten, säuregeätzten, reflektierenden und verspiegelten Glasarten, zusätzlich zu den vier Litech-Ausführungen, Kunstleder, Stoff sowie den Sahara- und Taiga-Essenzen.

FR Le raffinement des finitions, les couleurs tendances, la perfection des accessoires: Cover freestanding est un projet coordonné à 360°, où chaque élément de la composition contribue à la définition d'un ensemble homogène, raffiné et élégant. La structure en aluminium est disponible en six finitions (brown, piombo, platino et bronzo), les portes en verre trempé dans les tons brillants et mats de la gamme Ecolorsystem, diamante, sahara, taiga, reflex et dans toutes les variantes de verre transparent, satiné, réfléchissant et miroir, aussi que les 4 finitions Litech, similicuir, tissu et bois sahara et taiga.

ES Los acabados refinados, los colores de moda, la perfección de los accesorios: el Cover freestanding es un proyecto coordinado a 360° en el que cada elemento de la composición contribuye a la definición de un conjunto homogéneo, refinado y elegante. La estructura de aluminio está disponible en seis acabados (aluminio, nero, brown, piombo, platino y bronzo), las puertas de cristal templado en los tonos brillo y mate de la gama Ecolorsystem, diamante, sahara, taiga, reflex y en cristal totalmente transparente, grabado, reflectante y espejo además de los 4 acabados Litech, simil cuero, tejido y madera sahara y taiga.

RU Изысканная отделка, модные цвета, совершенство аксессуаров: отдельностоящая композиция Cover — это всесторонне скоординированный проект, в котором каждый элемент композиции вносит свой вклад в создание однородного, изысканного, элегантного целого. Алюминиевая конструкция предлагается в шести вариантах цвета (алюминий, черный, коричневый, свинец, платина и бронза), двери из закаленного стекла в глянцево-й и матовой отделке в цветах серии Ecolorsystem — diamante, sahara, taiga, reflex, а также из любого прозрачного, травленого, отражающего стекла или зеркала в дополнении к четырем вариантам отделки Litech, синтетической кожи, ткани, натурального шпона — sahara и taiga.

汉语 细腻的表面处理、时下趋势的色彩以及完美的各式配件：Cover freestanding 为一项 360° 全方位协调的设计方案，当中的每项组合元素皆完备了一个均质、精致和典雅的整体。以铝合金打造的结构有六种表面处理可供选择（铝、黑、棕、铅、铂金和青铜），门扇除了有 Ecolorsystem 亮面和哑光色系的钢化玻璃、Diamante、Sahara、Taiga、Reflex 和所有透明、酸化、反射和镜面玻璃之外，另有 4 种 Litech 岩板的表面处理、仿真皮革、布面、Sahara 和 Taiga 木材。









EN A storage system of the latest generation, in which all components are custom made, from the doors to the accessories, from the structure to complements. The technology allows to create a layout characterised by a dedicated passage opening, which offers access to the actual walk-in closet by passing through the architectural element that frames the night area.

IT Un sistema armadio di ultima generazione, nel quale tutti i componenti, dalle ante agli accessori, dalla struttura ai complementi, sono realizzati su misura grazie a un sistema di produzione "custom made". La tecnologia utilizzata permette di creare una composizione caratterizzata da un vano di passaggio dedicato, che consente di accedere alla cabina armadio vera e propria transitando attraverso la quinta architettonica che rappresenta il fronte principale sulla zona notte.

DE Ein modernes Schrankssystem, welches Komponenten, von Tueren bis zu Zubehoeren, von der Struktur bis zu Komplementen, in Sondermasse produziert werden, danke zu einem „custom-made“ Verarbeitungssystem. Die eingesetzte Technologie ermöglicht eine Komposition, die sich durch einen eigenen Durchgang auszeichnet, der den Zugang zum eigentlichen begehbaren Kleiderschrank ermöglicht, indem er durch die architektonische Kulissee führt, die die Hauptfront des Schlafbereichs darstellt.

FR Un système armoire de nouvelle génération, dans lequel tous les composants, des portes aux accessoires, de la structure aux compléments, sont toujours réalisés "sur mesure". La technologie utilisée permet de créer une composition caractérisée par un passage dédié, qui permet d'accéder au vrai dressing en passant par la structure architecturale qui constitue la façade principale de l'espace nuit.

ES Un sistema de armario de ultima generación, en el que todos los componentes, de las puertas a los accesorios, de la estructura a los accesorios, estan realizados a medida. La tecnología utilizada permite crear una composición caracterizada por un pasillo dedicado, que permite acceder al vestidor propiamente dicho atravesando el fondo arquitectónico que representa la fachada principal de la zona de noche.

RU Современная гардеробная система, в которой все компоненты, от дверей до аксессуаров, от каркаса до комплектующих, изготавливаются по индивидуальному заказу благодаря системе производства на заказ. Используемая технология позволяет создать композицию, характеризующуюся наличием специального портала, который позволяет попасть в собственно гардеробную, пройдя через архитектурную композицию, представляющую собой главный фасад спальни зоны.

汉语 最新一代的衣柜系统, 当中所有的部件, 从门扇到配件, 从结构到辅助件, 皆经定制化的生产系统按照尺寸定制。 我们采用技术打造出的组合柜以专门通道尤为特色, 可通过这条通道穿梭于代表卧室主要正面的隔墙以及步入式衣橱。



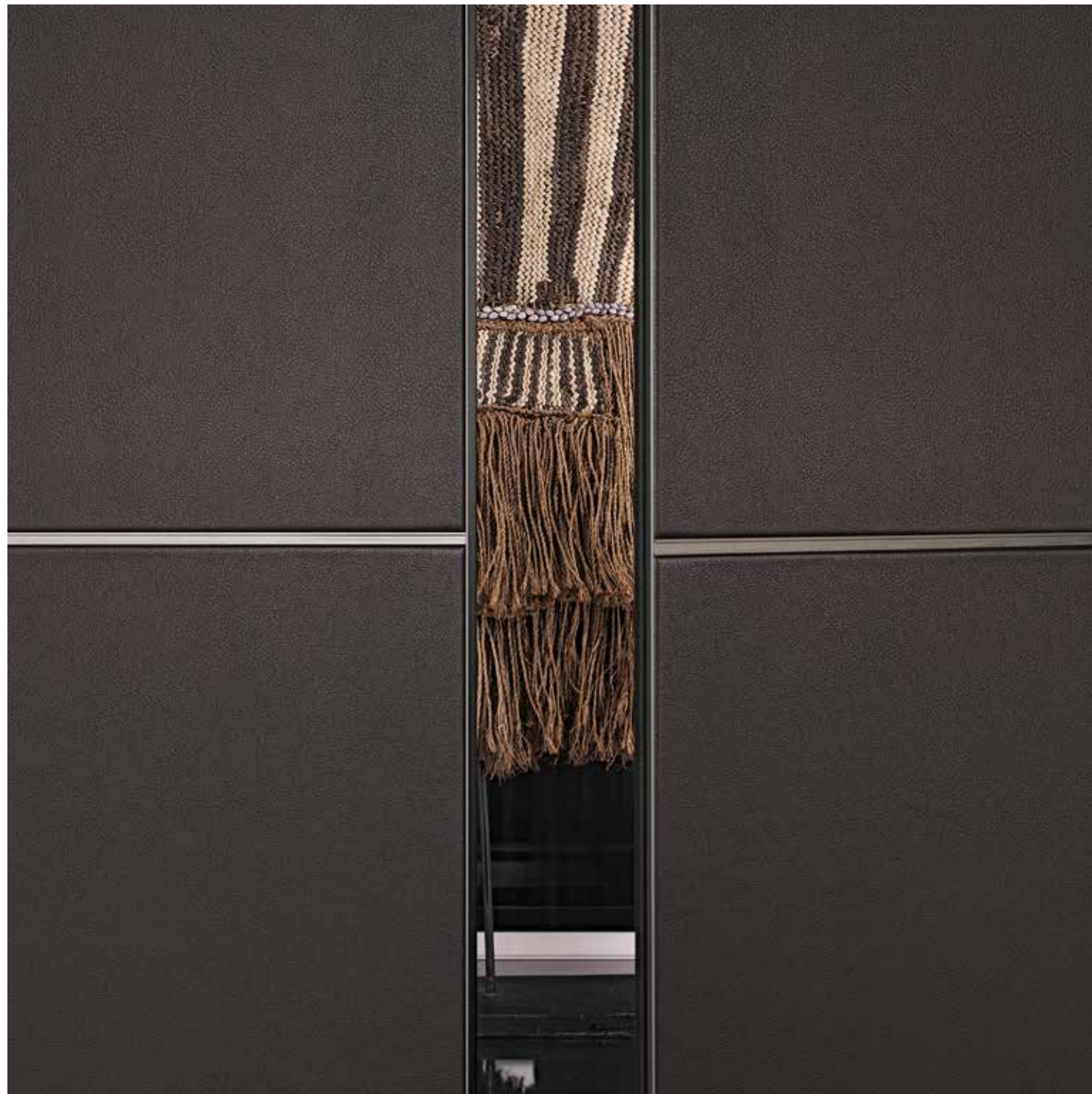



Structure: 303 bronzo
Synthetic leather doors: 159 etna
Shelves, sides and back panel: 63 grigio trasparente

In this photo
Coffee table: Planet
Vanity



Structure: 83 piombo
Doors: 63 grigio trasparente
Floor base and top: 09 melaminico rovere grigio
Shelves, sides and back panel: 63 grigio trasparente
Synthetic leather accessories: 154 argilla



EN The suspended drawer unit with two drawers is exclusively fixed to the uprights of the doors. The top is made of a continuous aluminium profile, created with the exclusive "folding" technology, in which the top is inserted with an extremely clean design. The drawers are equipped with push opening and totally extractable runners of the latest generation for a perfect functionality.

IT La cassettera sospesa a due cassetti è ancorata esclusivamente ai montanti strutturali delle ante. Il piano superiore è caratterizzato da un profilo continuo in alluminio, realizzato con la tecnologia esclusiva "folding" nel quale si inserisce il top per un'estrema pulizia formale. I cassetti sono dotati di guide push ad estrazione totale di ultima generazione per una perfetta funzionalità.

DE Abgehaengtes Schubladenelement ist direkt zu strukturellen Pfosten den Tueren verbindet. Die Abdeckungs-platte besteht aus einem Profil aus Aluminum, realisiert danke zur „Folding“ Verarbeitung, die erlaeuibt eine extreme formliche Sauberkeit. Schubladen sind mit push-Voellaufzuegen ausgestattet um eine perfekte Funktionalitaet zu erreichen.

FR Le bloc tiroir suspendu avec deux tiroirs n'est fixé qu'aux montants des portes. Le plateau supérieur est constitué d'un profil continu en aluminium, réalisé avec la technologie exclusive "folding", dans lequel le plateau est fixé avec un résultat extrêmement propre. Les tiroirs sont équipés avec des guides avec ouverture à pression et avec extraction totale de la dernière génération pour une fonctionnalité parfaite.

ES La cajónera colgante a dos cajones está anclada exclusivamente a los montantes estructurales de las puertas. La planta superior está realizada con un perfil continuo en aluminio, creado con la tecnología exclusiva "folding" en la que se inserta el top para una limpieza estética extrema. Los cajones están equipados con guías push a extracción total de última generación para la funcionalidad perfecta.

RU Подвесной шкаф с двумя ящиками крепится только к стойкам дверей. Крышка ящика выполнена из единого алюминиевого профиля, согнутого по эксклюзивной технологии «folding», в который вставляется верх, обеспечивающий исключительную формальную чистоту. Выдвижные ящики оснащены направляющими последнего поколения с полным выдвижением и системой «пуш-пулл», обеспечивающими идеальную функциональность.

汉语 悬挂式双层抽屉柜仅固定在门扇的结构立柱上。上部台面以铝合金的连续轮廓打造，以独家“折弯”技术制成，为台面创造极度简洁的造型线条。抽屉配备最新一代抽拉式推弹导轨，功能性完美。



Structure: 83 piombo
Suspended drawer unit: 09 melaminico rovere grigio
Top: 68 specchio grigio
Internal drawer: UB09 melaminico cuoio brown



Structure: 304 platino
Doors: 67 riflettente chiaro
Floor base and top: 09 melaminico rovere grigio
Sides and back panel: 67 riflettente chiaro
Shelves: 63 grigio trasparente

In this photo
Table: Manta
Coffee table: Planet
Door: Moon



Structure: 304 platino
Doors: 67 riflettente chiaro
Floor base and top: 09 melaminico rovere grigio
Sides and back panel: 67 riflettente chiaro
Shelves: 63 grigio trasparente
Suspended drawer units: 09 melaminico rovere grigio

In this photo
Table: Manta
Suspended cabinet: Self bold
Door: Moon

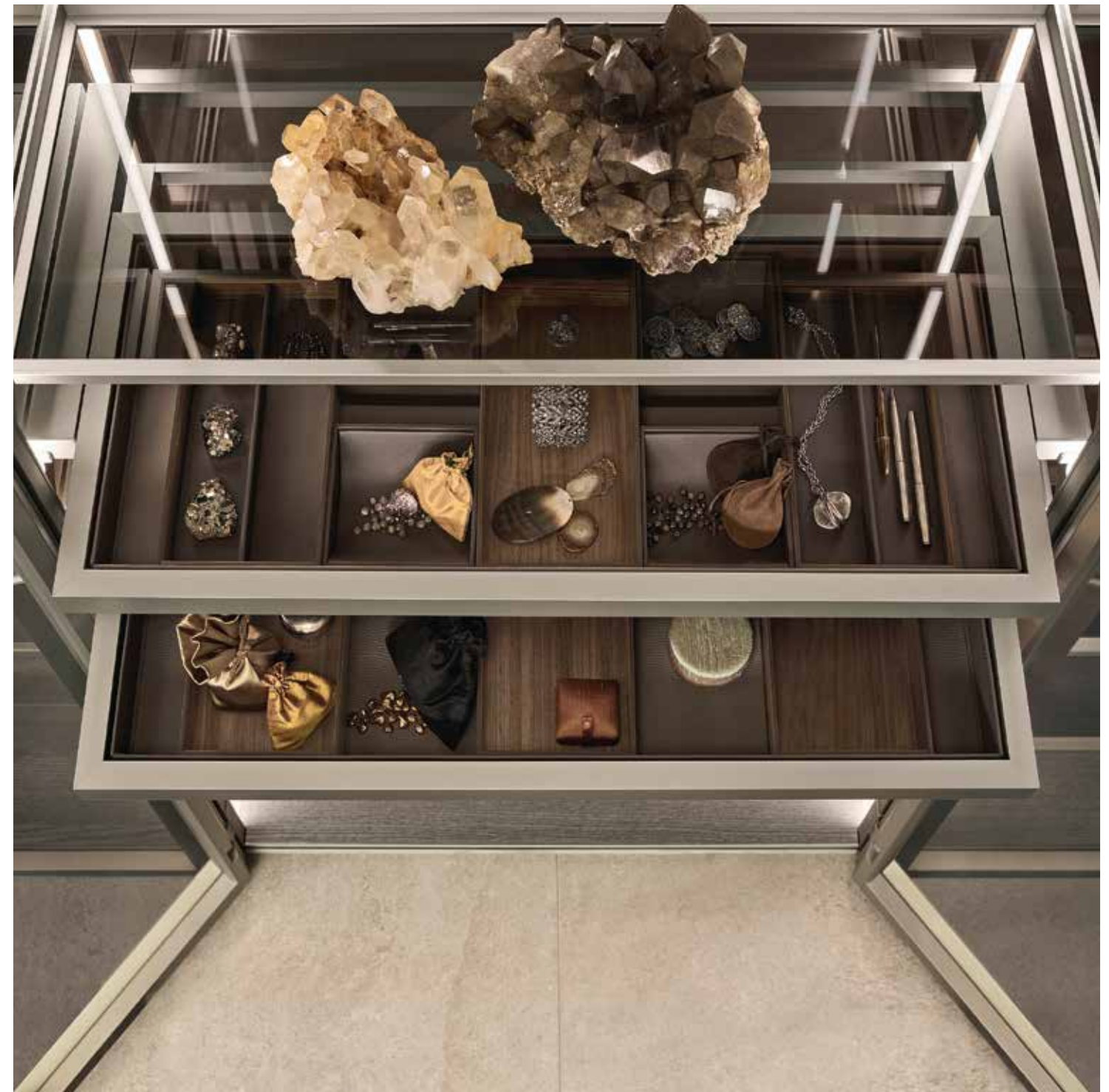

Structure: 304 platino
Doors: 67 riflettente chiaro
Floor base: 09 melaminico rovere grigio
Shelves: 63 grigio trasparente
Synthetic leather accessories: 154 argilla



TECHNICAL DESCRIPTION

EN A storage system of the latest generation, where all the components, from the doors to the accessories, from the structure to the complements, are custom-made. The high performances of Cover freestanding come from a technological advanced aluminium structure. The uprights, on which the doors are adjusted, conceal the led lighting. The system provides the freestanding version, with sides and back panels completely finished, or the version between walls, with optional adjusting fillers for both sides and top, to close eventual differences in the wall.

IT Un sistema armadio di ultima generazione, nel quale tutti i componenti, dalle ante agli accessori, dalla struttura ai complementi, sono realizzati su misura grazie a un sistema di produzione "custom-made". Le alte prestazioni di Cover freestanding nascono da una struttura in alluminio tecnologicamente innovativa. I montanti, su cui si regolano le ante ospitano l'illuminazione a led. Il sistema prevede la versione freestanding, con lato posteriore e fianchi completamente rifiniti, oppure la versione interparete, con fasce di aggiustaggio opzionali superiori e laterali, per chiudere gli eventuali fuori squadra delle pareti.

DE Ein Schranksystem der nächsten Generation, in dem alle Komponenten, von den Platten bis zum Zubehör, von der Struktur bis zu den Zusätzen dank eines Produktionssystem individuell nach Maß gefertigt werden. Der hohe Leistungsumfang des Cover Freestanding ergibt sich aus einer technologisch innovativen Aluminiumstruktur. Die Stände, auf dem die Platten angepasst werden, verfügen über eine LED-Beleuchtung. Das System sieht die Version freestanding mit vollständig geschlossenen Rückseiten und Seiten vor. Alternativ gibt es die Ausführung „interparete“, mit optionaler obiger und seitlicher Einstellung der Wände.

FR Un système armoire de nouvelle génération, dans lequel tous les composants, des portes aux accessoires, de la structure aux compléments, sont fabriqués grâce à un système de production "sur mesure". Les hautes performances de Cover freestanding proviennent d'une structure en aluminium technologiquement innovante. L'éclairage led peut être installé sur les montants, qui régulent les portes. Le système est disponible en version freestanding avec l'arrière et les côtés complètement finis, ou en version entre murs avec fileurs lateraux et supérieurs optionnels, pour fermer les différences d'épaisseur de parois.

ES Un sistema armario de última generación, en el cual todos los componentes, de las puertas a los elementos accesorios, de la estructura hasta los complementos, son realizados a medida, gracias a un sistema de producción "custom-made". El alto rendimiento de Cover freestanding surgen de una estructura en aluminio tecnológicamente innovadora. Los montantes en los cuales se ajustan las puertas acomodan una iluminación por leds. El sistema prevé la versión freestanding, con parte trasera y paneles laterales completamente acabados, o la versión interpared, con bandas de ajuste opcionales superiores y laterales, para cerrar cualquier descuadre de las paredes.

RU Современная гардеробная система, в которой все компоненты, от дверей до аксессуаров, от Каркаса до внутреннего оснащения до комплектующих, изготавливаются по индивидуальному заказу благодаря системе производства на заказ. Высокие эксплуатационные характеристики отдельно без пробела стоящей композиции Cover обусловлены технологически инновационной алюминиевой конструкцией. В стойках, на которых крепятся двери, размещена светодиодная подсветка. Система включает в себя отдельно стоящую версию с полностью отделанными задней и боковыми стенками или межстенную версию с дополнительными верхними и боковыми регулировочными планками для обеспечения примыкания к любым неровным стенам.

汉语 最新一代的衣柜系统, 当中所有的部件, 从门扇到配件, 从结构到辅助件, 皆经定制化的生产系统按照尺寸定制。Cover freestanding 的高性能来自创新科技研发的铝合金结构。可调整门扇的立柱上设有 LED 照明系统。这套系统为独立式版本, 后方和侧边皆以精致的收边工艺完成; 分隔墙式的版本可选配上方和侧边调节带, 用于消除墙面的任何不平整和落差。

Accessories fixing system



All the elements are fixed directly to the uprights, without visible screws, and the layout can be easily modified over time.

Middle room

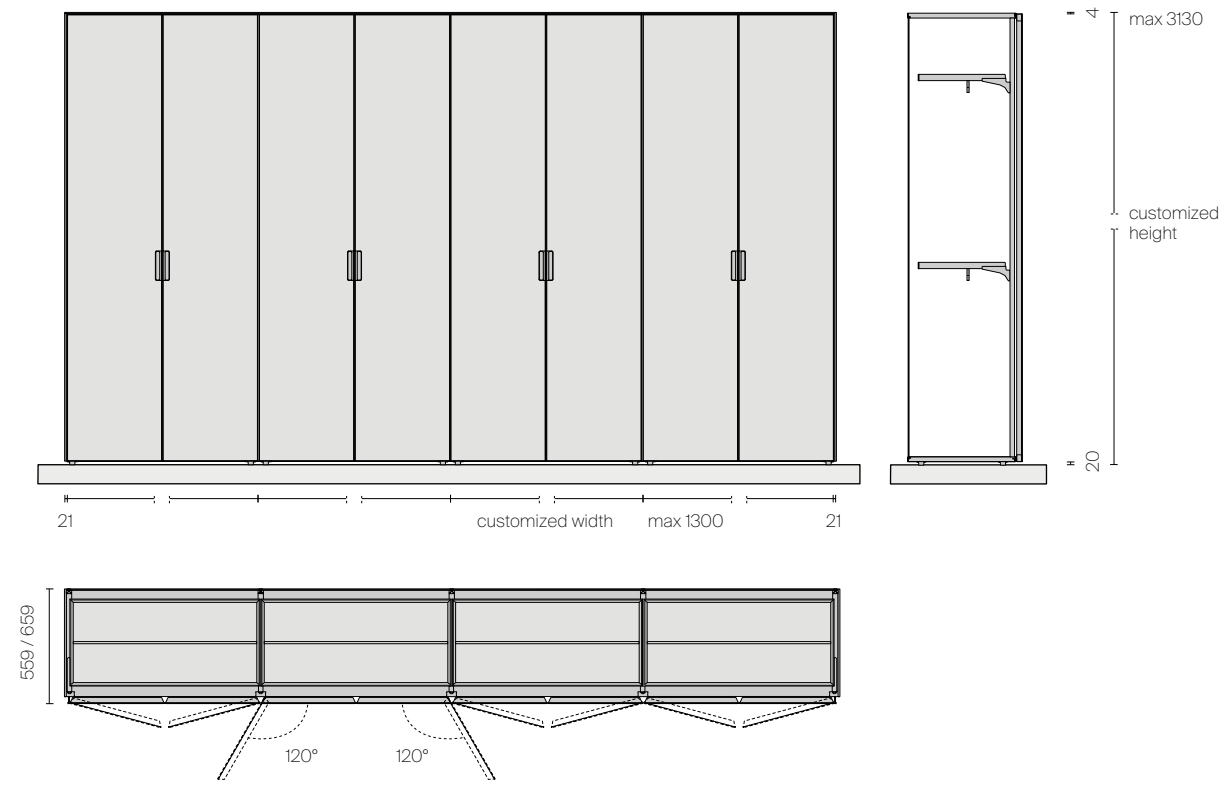

Niche

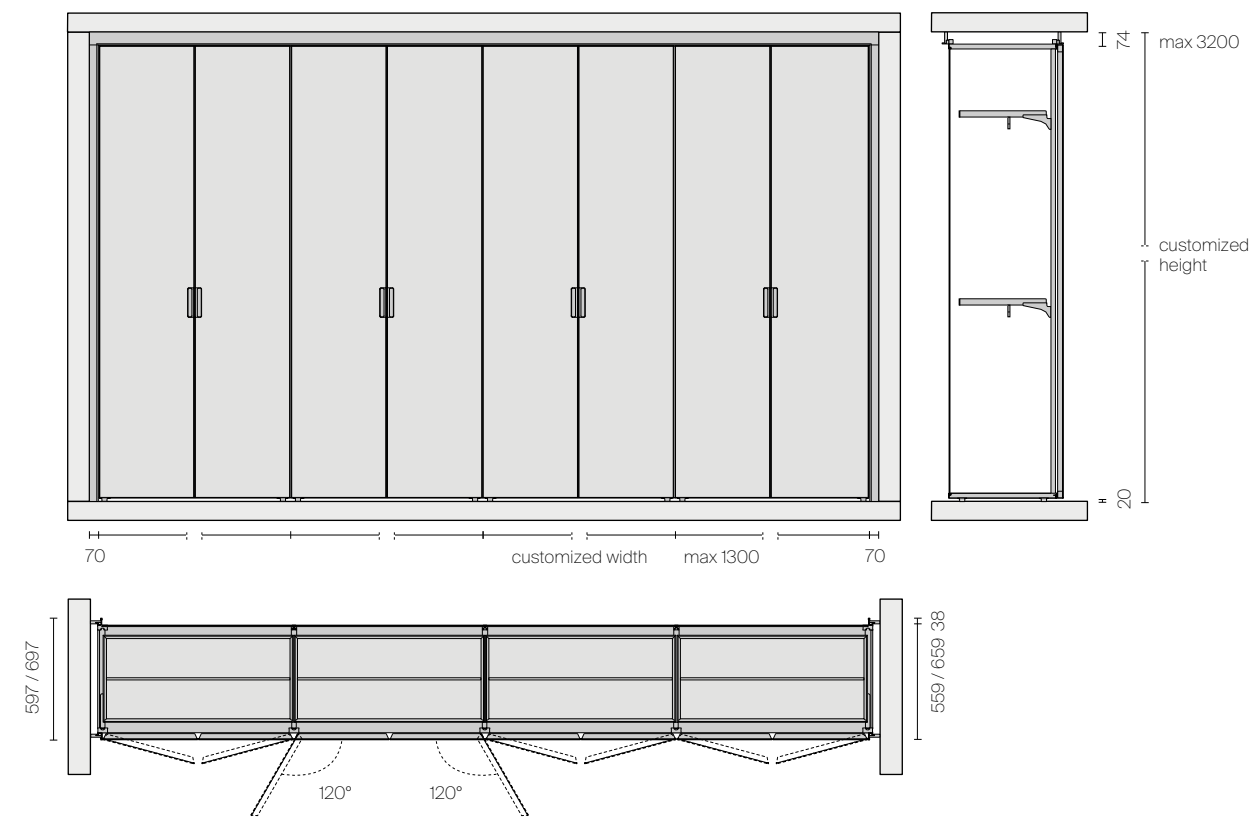

Middle room composition

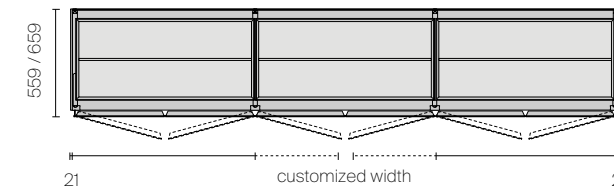

Composition next to a wall

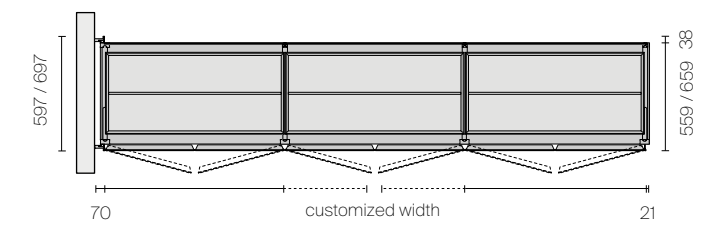

Composition in niche with passage opening

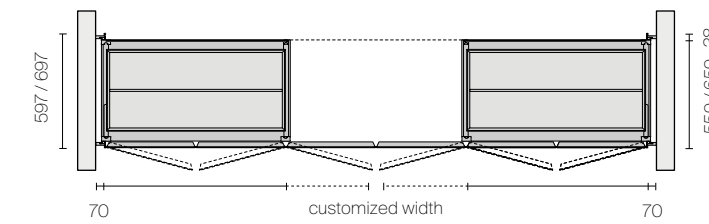

Composition in niche with passage opening and opposing doors

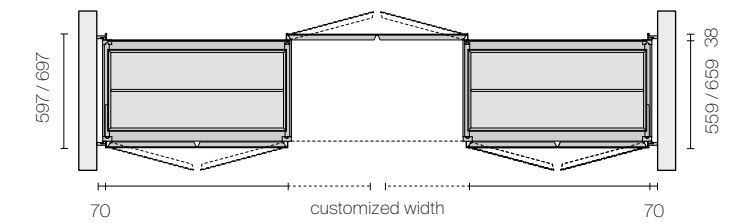

Composition in niche with side passage opening

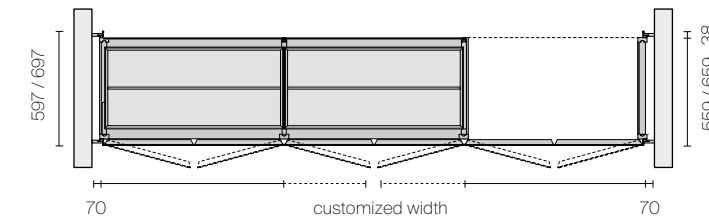

Composition in niche with side passage opening and opposing doors

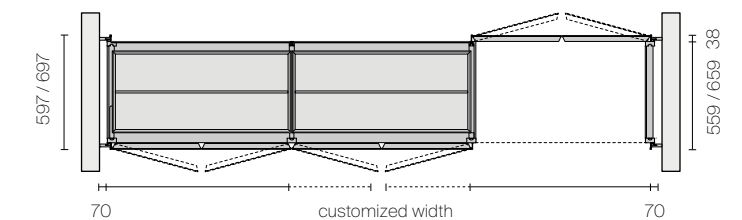

Corner composition

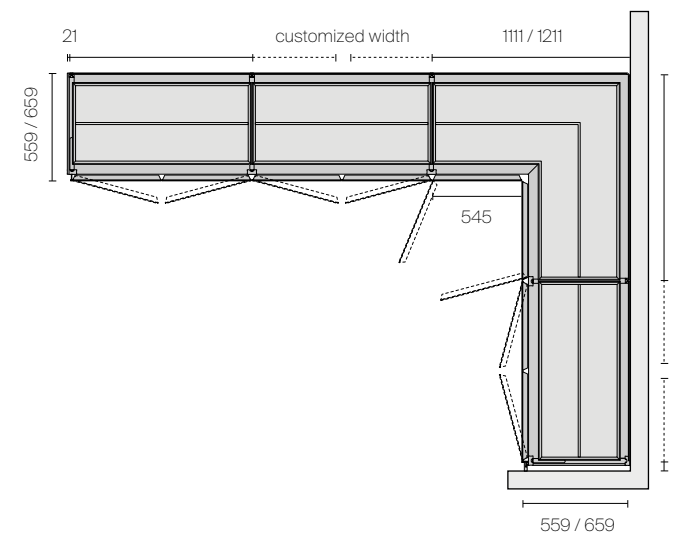

C-shaped composition

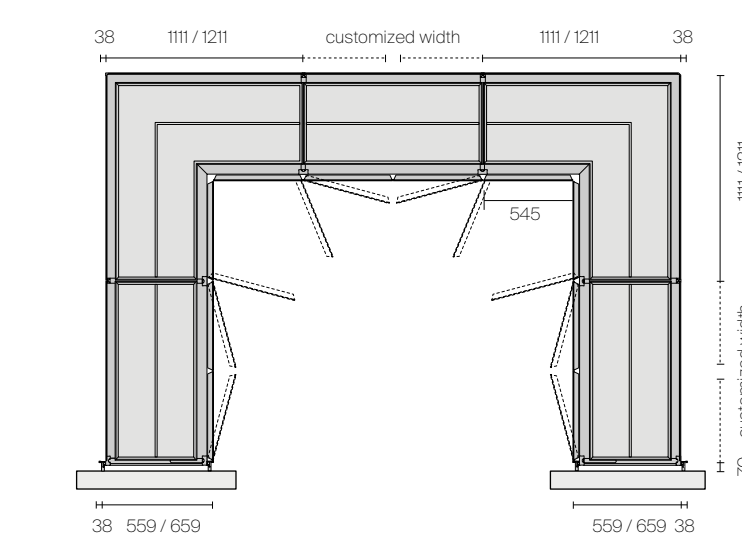

DOORS

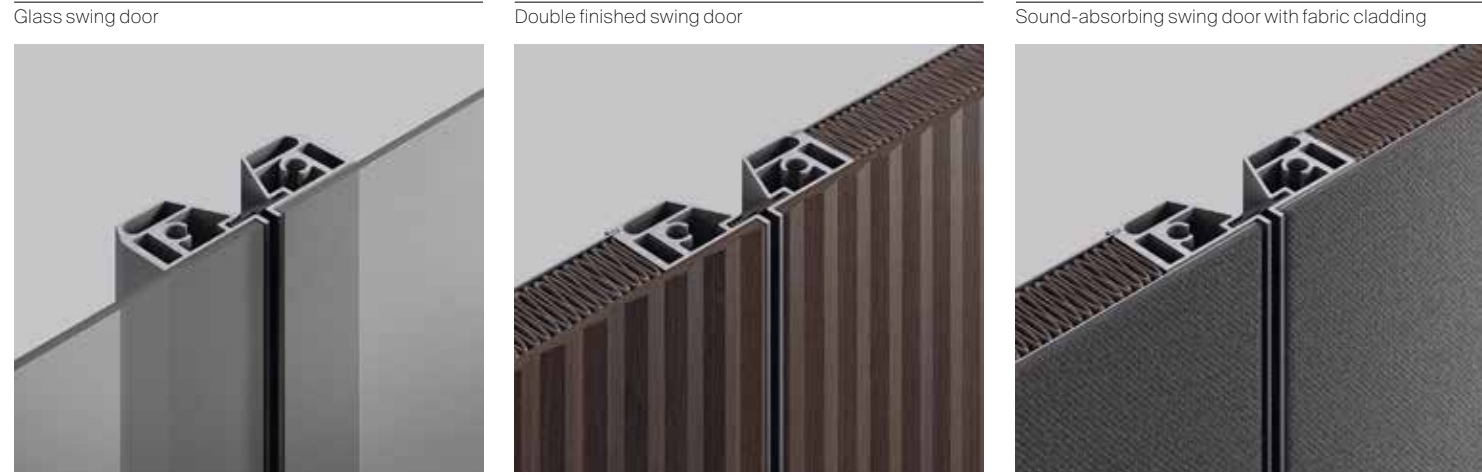

DOORS AESTHETICAL TYPOLOGIES

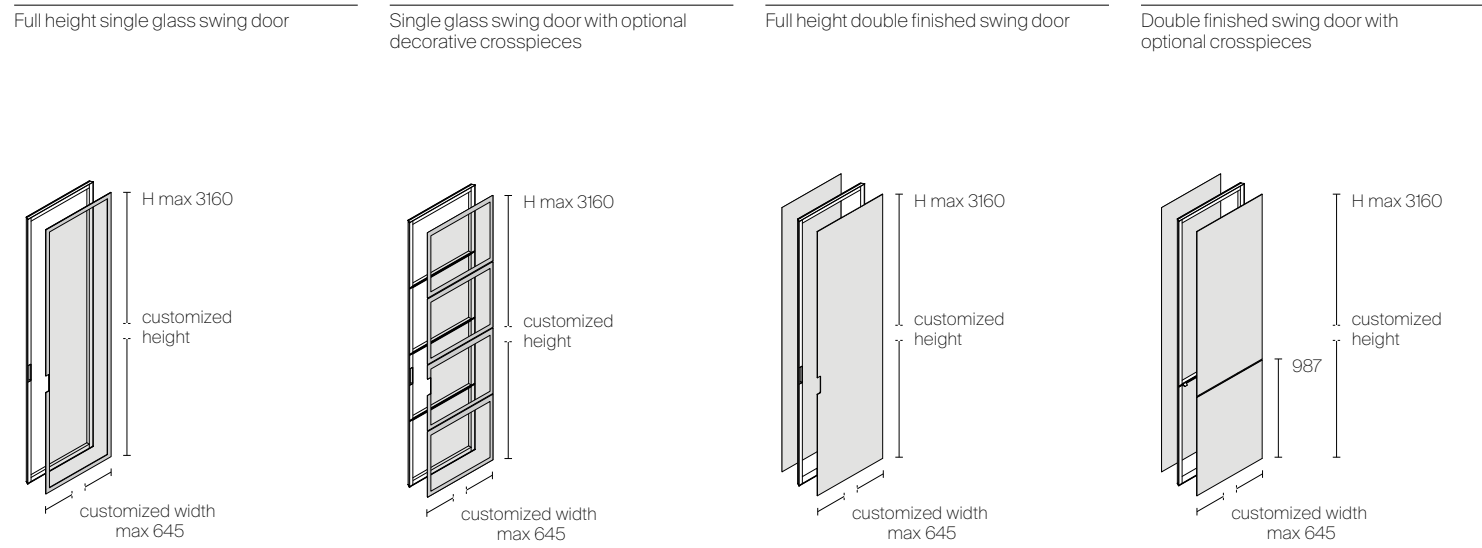

HANDLES



1. Handle 2013 in die-casting aluminium
2. Handle 2014F in die-casting aluminium with fixed lever tumbler / Handle 2014C with hook lock and key
3. Handle 2021 integrated in the crosspiece

STRUCTURAL ELEMENTS

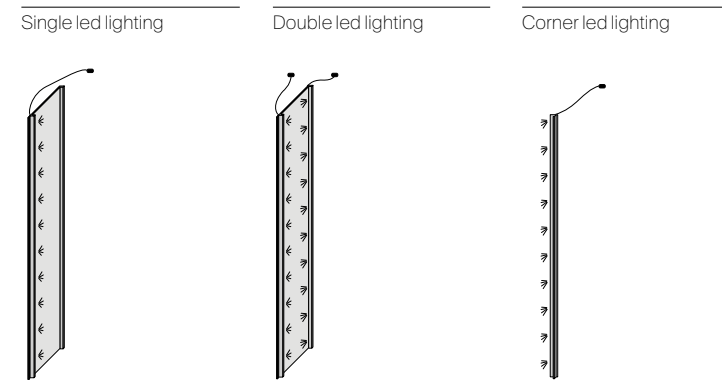
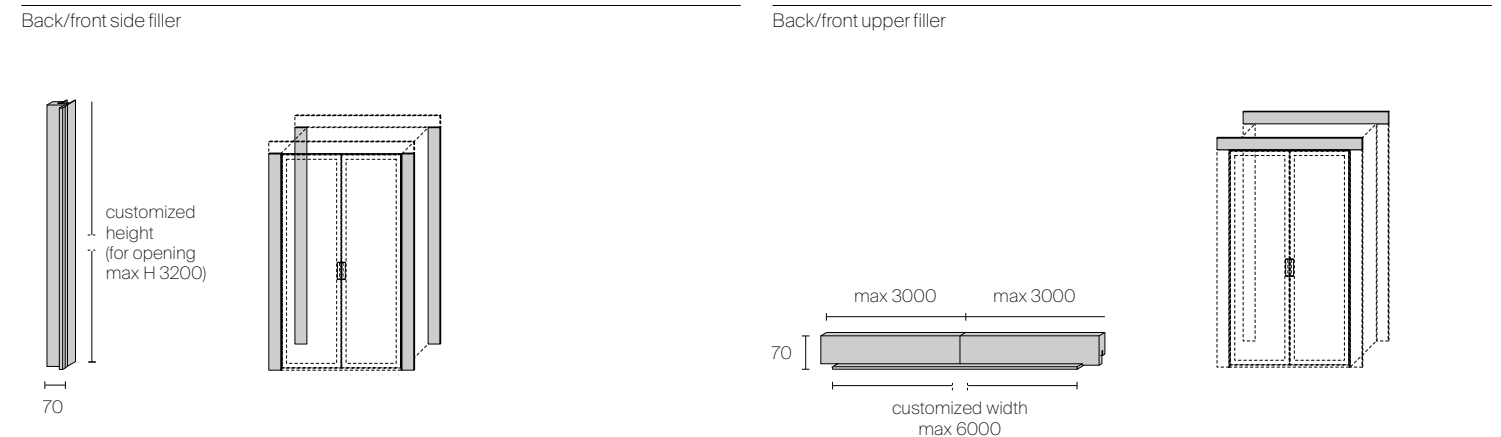
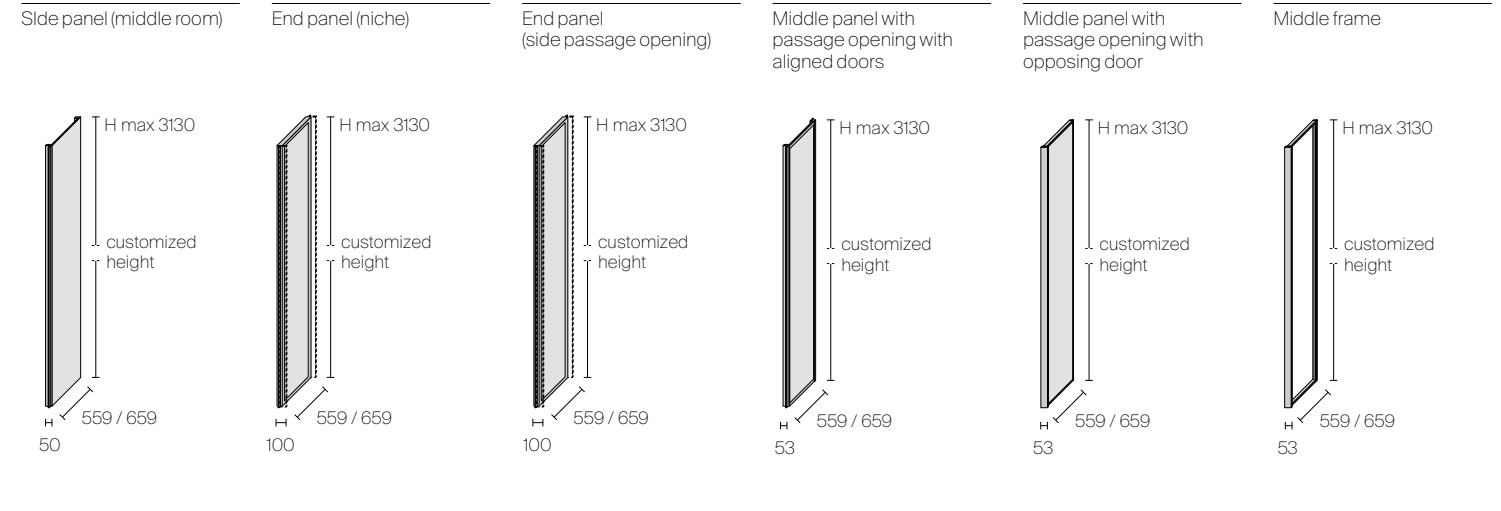
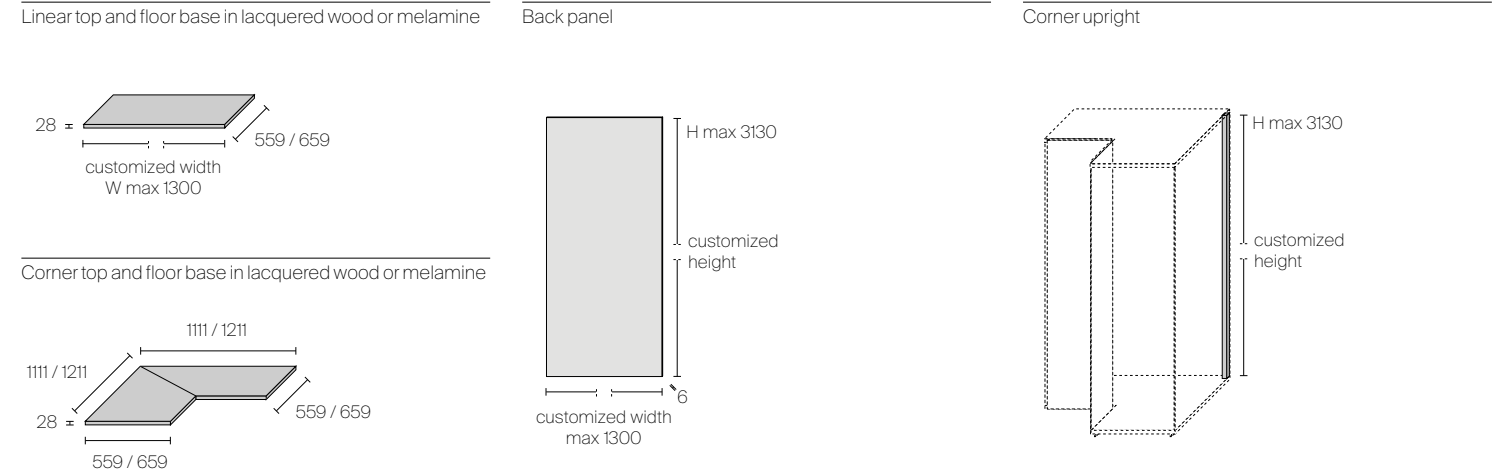

Glossy glass



Matt glass



Synthetic leather



Transparent glass



Sahara wood



Taiga wood



Sahara glass



Taiga glass



Material fabric



Litech



Diamante glass



Fibra glass





COVER OPEN IS A STORAGE SYSTEM THAT COMBINES AN ALUMINIUM STRUCTURE WITH GLASS SIDES AND BACK PANELS. THE SYSTEM ALLOWS TO CREATE FULLY CUSTOMISED LINEAR OR CORNER COMPOSITIONS. THE VARIETY OF GLASS FINISHINGS OFFERS A DIVERSE RANGE OF AESTHETICS: FROM ENTIRELY TRANSPARENT "DISPLAY CASES" TO TRADITIONAL WARDROBES IN MATT OR GLOSSY GLASS.

IT Cover open è un sistema di contenitori con struttura in alluminio e con fianchi laterali e schienali in vetro. Il sistema prevede la possibilità di creare composizioni perfettamente su misura, lineari o con angoli. La varietà delle finiture dei vetri permette la definizione di configurazioni esteticamente differenti: dalla "teca" interamente trasparente all'armadiatura tradizionale in vetro opaco o lucido.

DE Cover open ist ein Behältersystem mit einem Aluminiumrahmen und Seiten- und Rückwänden aus Glas. Das System bietet die Möglichkeit, in Maßanfertigung, linear oder mit Ecken, perfekte Kompositionen zu erstellen. Die Vielfalt der Glasoberflächen ermöglicht die Definition von ästhetisch unterschiedlichen Konfigurationen: vom völlig transparenten „Schaukasten“ bis hin zur traditionellen Vitrine aus mattem oder poliertem Glas.

FR Cover open est un système de rangement avec une structure en aluminium, des panneaux latéraux et un fond en verre. Ce système offre la possibilité de créer des compositions 100% personnalisées, linéaires ou avec angles. La variété des finitions du verre permet d'opter pour des configurations esthétiquement différentes: de la "vitrine" totalement transparente à la penderie traditionnelle en verre mat ou brillant.

ES Cover open es un sistema de cajones con estructura de aluminio y laterales y fondos traseros de cristal. El sistema brinda la posibilidad de crear composiciones perfectamente personalizadas, lineales o con esquinas. La variedad de acabados del vidrio permite definir configuraciones estéticamente diferentes: desde el "armario" totalmente transparente hasta el tradicional mueble de vidrio opaco o brillante.

RU Cover open — это система хранения с алюминиевым каркасом и стеклянными боковыми и задними панелями. Система позволяет создавать идеальные линейные или угловые композиции. Разнообразие видов отделки стекла позволяет создавать эстетически различные конфигурации: от полностью прозрачной «витрины» до традиционных шкафов из крашеного матового или глянцевого стекла.

汉语 Cover open 为铝合金结构搭配玻璃侧板和背板的收纳单元系统。这套系统可完美地创造出线性或转角式的定制组合。多样的玻璃表面处理创造出各式不同的美感配置：从完全透明的“小首饰盒”到亮面和哑光玻璃打造的传统衣柜系统。



EN Cover Open is emphasized by aluminium front profiles, designed to enhance the wardrobe elements and to highlight their aesthetic minimalism. Wide is the variety of materials and finishings: the structure is available in the 6 colours of the Cover system. Top and floor base are available in lacquered wood in the 46 Ecolorsystem colours, as well as in the 3 melamine finishings. The accessories are available in synthetic leather in the 8 exclusive Rimadesio colours.

IT Cover Open è scandito da profili frontali in alluminio, progettati per valorizzare gli elementi guardaroba e rimarcare il minimalismo estetico. Ampia la varietà di materiali e finiture: la struttura è disponibile nelle 6 cromie previste dal sistema Cover. Top e basamento interno sono disponibili in legno laccato nei 46 colori Ecolorsystem, oltre che nelle 3 finiture in melaminico. Gli accessori sono disponibili in similpelle in 8 tonalità esclusive Rimadesio.

DE Cover Open wird von Aluminium-Frontprofilen unterbrochen, die die Garderobenelemente aufwerten und ihren ästhetischen Minimalismus unterstreichen sollen. Es gibt eine Vielzahl von Materialien und Oberflächen: Die Struktur ist in den 6 vom Cover-System bereitgestellten Farben erhältlich. Deckel- und Basisboden sind in lackiertem Holz in den 46 Ecolorsystem Farben, sowie in den 3 Melamin-Ausführungen erhältlich. Die Accessoires sind in Kunstleder in 8 exklusiven Rimadesio-Farben erhältlich.

FR Cover Open est caractérisé par de profils frontaux en aluminium, conçus pour valoriser les éléments dressing et souligner l'esthétique minimaliste. Les matériaux et les finitions sont proposés dans une grande variété: la structure est disponible dans les 6 couleurs prévues par le système Cover. Top et base au sol intérieure sont disponibles en bois laqué dans les 46 couleurs Ecolorsystem, ainsi que dans les 3 finitions en mélaminé. Les accessoires sont disponibles en similicuir en 8 tonalités exclusives Rimadesio.

ES Cover Open presenta perfiles frontales de aluminio, diseñados para realzar los elementos del vestidor y remarcar su minimalismo estético. Existe una amplia variedad de materiales y acabados: la estructura está disponible en los 6 colores del sistema Cover. El top y la base interna están disponibles en madera lacada en los 46 colores de Ecolorsystem, así como en los 3 acabados de melamina. Los accesorios están disponibles en simil cuero en 8 tonalidades exclusivas de Rimadesio.

RU Cover Open характеризуется алюминиевыми фронтальными профилями, призванными усилить элементы гардероба и подчеркнуть их эстетический минимализм. Существует широкий выбор материалов и отделок: каркас доступен в 6 цветах системы Cover. Верх и внутреннее основание доступны в лакированном дереве в 46 цветах Ecolorsystem, а также в 3 вариантах отделки меламином. Комплекующие предлагаются из эко-кожи 8 эксклюзивных цветов Rimadesio.

汉语 Cover Open 以铝合金打造的前板轮廓尤为特色, 其加强了衣柜的多个部件并彰显极简的美感。多种材质和表面处理: Cover 系统的结构有 6 种色彩可供选择。台面和内部底座以漆面木材打造, 有 46 种 Ecolorsystem 色彩以及 3 种三聚氰胺的表面处理可供选择。配件的仿真皮革有 8 种 Rimadesio 的独家色调可供选择。

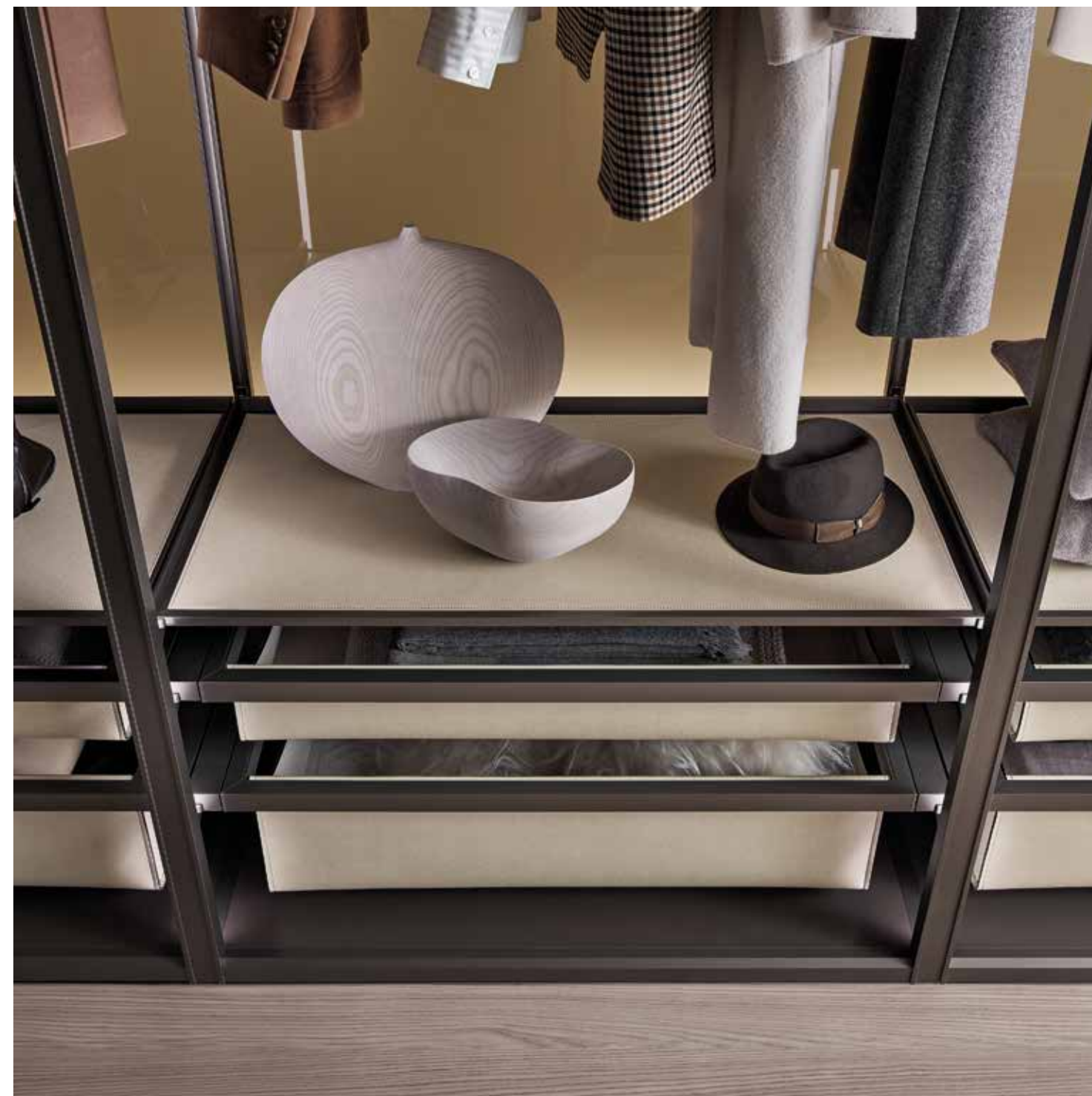

Structure: 303 bronzo
Sides and back panels: 04 acidato bronzo
Floor base: 303 bronzo
Synthetic leather accessories: 157 arena







TECHNICAL DESCRIPTION

EN The Cover Open system is always tailor-made in height and width and it is available in two depths. The structure and the innovative front profiles are made of aluminium. The base and top are available in melamine, in larice carbone, rovere grigio, olmo and brown finishings, and in the 46 Ecolorsystem lacquer colours.

IT Il sistema Cover Open è realizzato sempre su misura in altezza e larghezza ed è disponibile in due profondità. La struttura e gli innovativi profili frontali sono realizzati in alluminio. Il basamento e il top sono disponibili in melaminico, nelle finiture larice carbone, rovere grigio e olmo, brown e nei 46 colori laccati Ecolorsystem.

DE Das Cover Open-System wird immer in Höhe und Breite gemessen und ist in zwei Tiefen erhältlich. Die Struktur und die innovativen Frontprofile bestehen aus Aluminium. Das Gestell und die Platte sind aus Melamin, in den Ausführungen Larice Carbone, Rovere Grigio und Olmo, Brown und in den 46 Ecolorsystem-Lackfarben erhältlich.

FR Le système Cover Open est toujours réalisé sur mesure en hauteur et en largeur et disponible en deux profondeurs. La structure et les profils de face sont réalisés en aluminium. La base et le plateau sont disponibles en mélaminé, dans les finitions larice carbone, rovere grigio et olmo, brown et dans les 46 couleurs laquées Ecolorsystem.

ES El sistema Cover Open se realiza siempre a medida en altura y anchura y está disponible en dos profundidades. La estructura y los innovadores perfiles frontales son de aluminio. La base y la tapa están disponibles en melamina, en los acabados larice carbone, rovere grigio y olmo, brown y en los 46 colores lacados Ecolorsystem.

RU Система Cover Open всегда изготавливается на заказ по высоте и ширине и предлагается в двух вариантах глубины. Конструкция и инновационные фронтальные профили изготовлены из алюминия. Верх и внутреннее основание доступны из меламина, с отделкой из коричнево-черной лиственницы, черного дуба и коричневого вяза и в лакированных цветах 46 Ecolorsystem.

汉语 Cover Open 系统的高度和宽度皆按尺寸定制, 并有两种深度可供选择。结构以及创新的正面轮廓以铝合金打造。底座和台面可采用三聚氰胺板制作, 表面处理有木炭落叶松、灰橡木和榆木、棕, 以及 46 种 Ecolorsystem 的漆面颜色可供选择。

Accessories fixing system



All the elements are fixed directly to the uprights, without visible screws, and the layout can be easily modified over time.

STRUCTURAL ELEMENTS

Linear top and floor base in lacquered wood or melamine

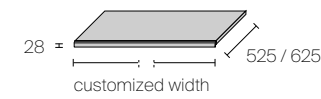

Corner top and floor base in lacquered wood or melamine

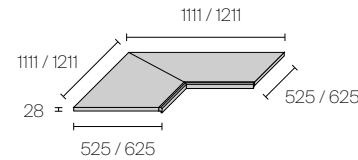

Back panel

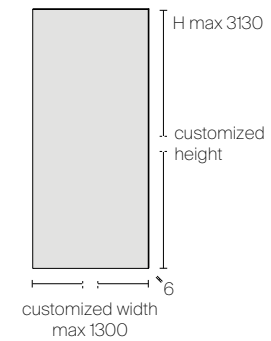

Side panel (middle room)

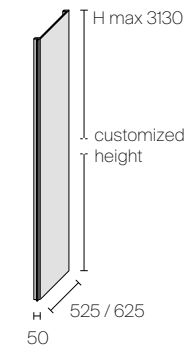

Middle frame

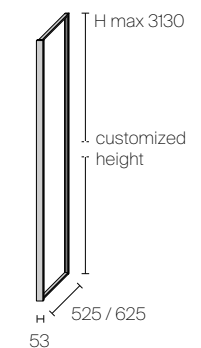

End panel (niche)

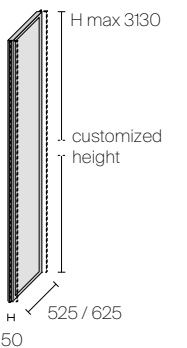

Back/front side filler

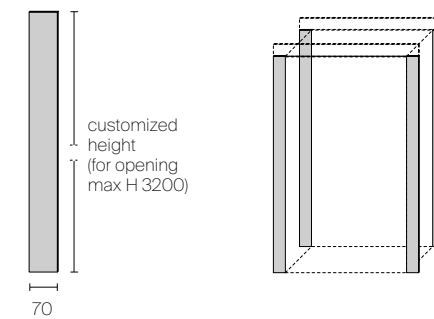

Back/front upper filler

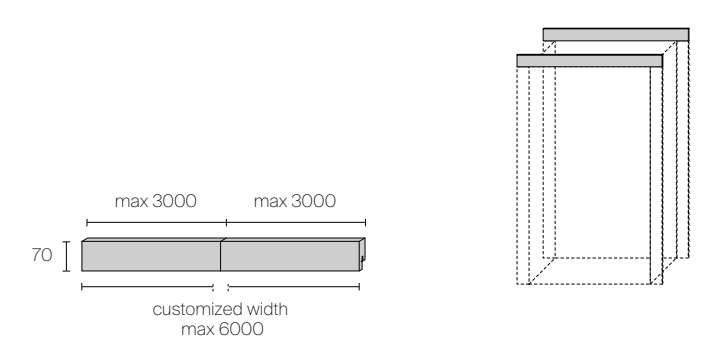

Corner upright

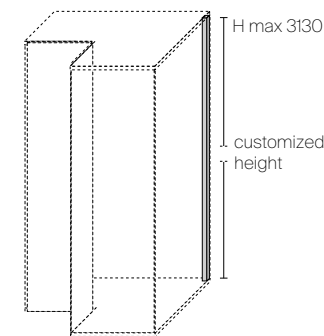

Single led lighting

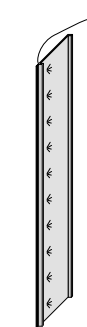

Double led lighting

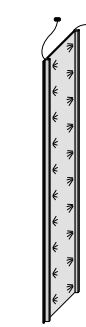

Corner led lighting

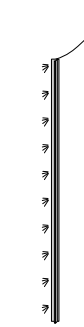

Cover Open

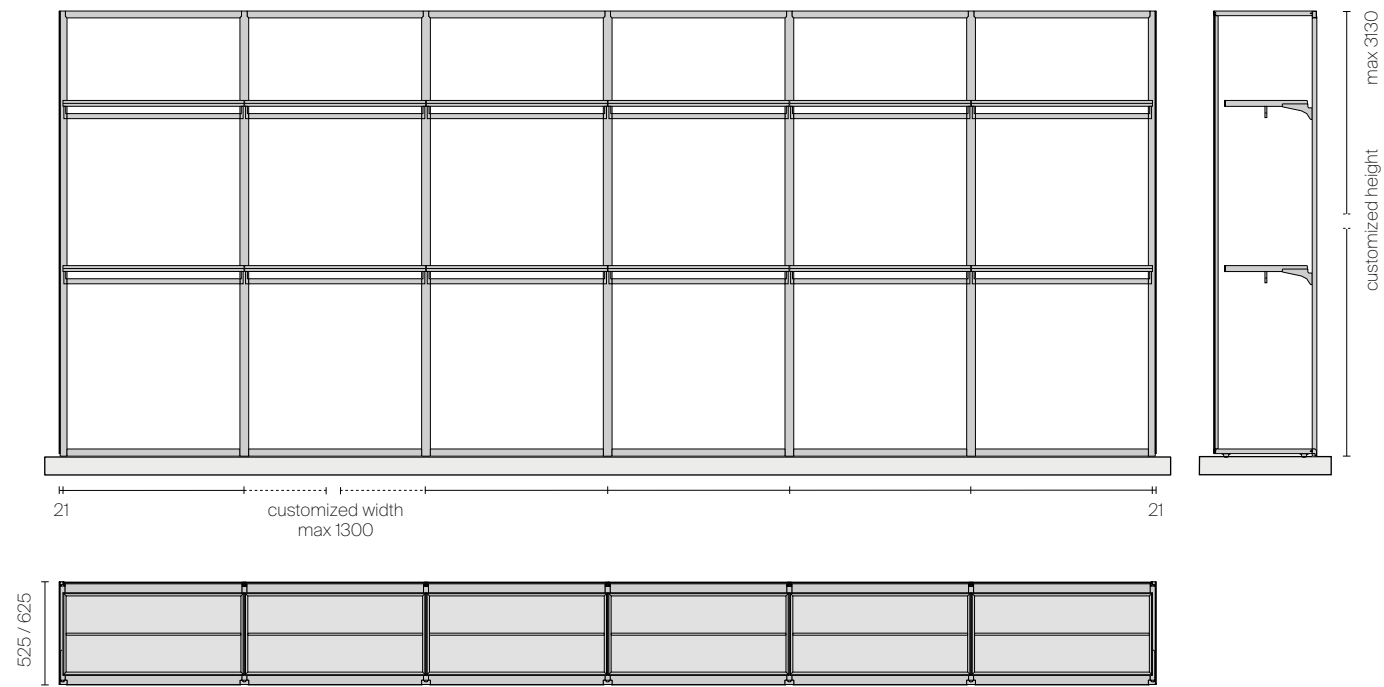

Cover Open + Cover freestanding



Linear composition Cover Open

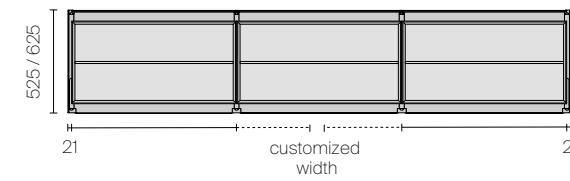

Linear composition Cover Open + Cover freestanding

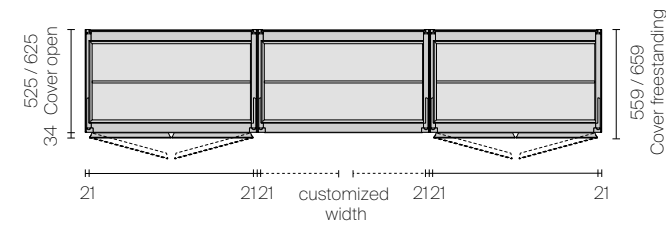

Corner composition Cover Open

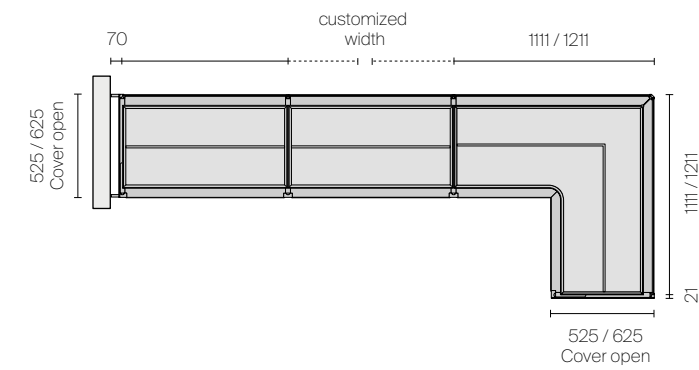

Corner composition Cover Open + Cover freestanding

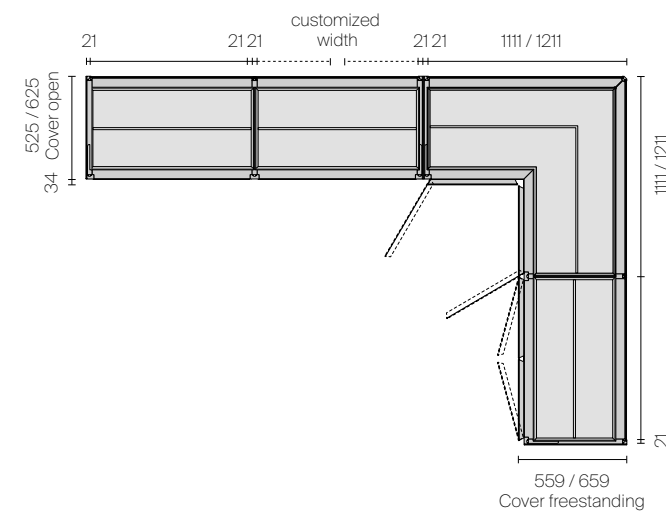

Linear composition Cover Open + Cover freestanding

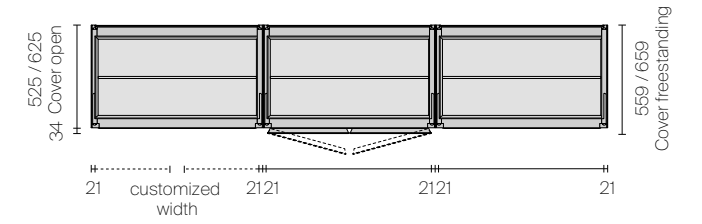

Linear composition Cover Open + Cover freestanding

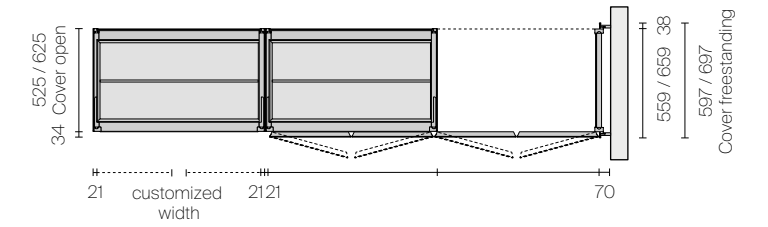

C-shaped composition Cover Open

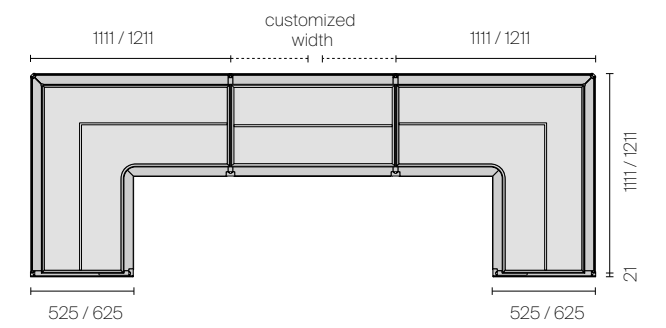

C-shaped composition Cover Open + Cover freestanding

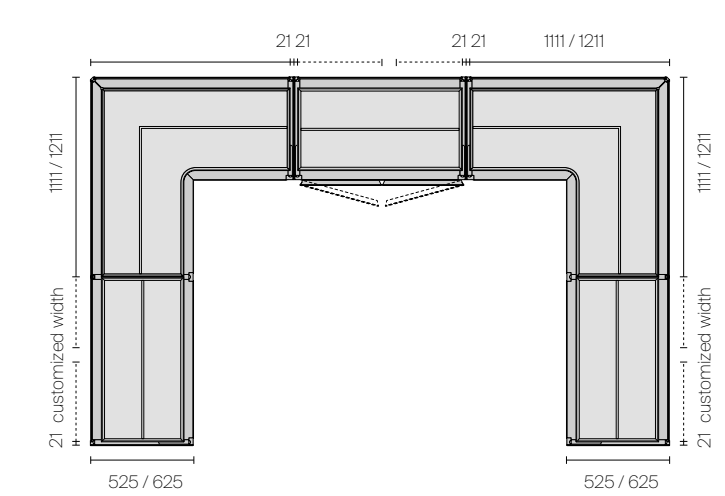

Cover

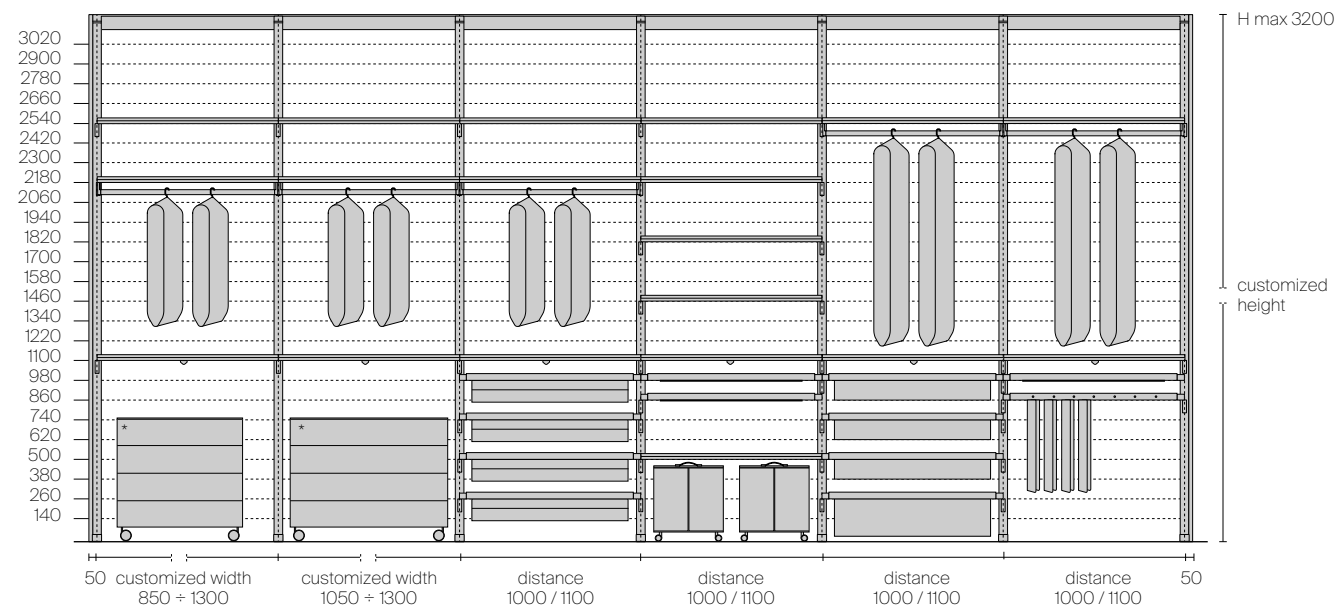

* drawer units are not available in customized dimension

TECHNICAL DESCRIPTION

EN The Cover project is updated with a programme of modular and sectional drawer units, manufactured using the latest production technologies for processing extruded aluminium: the drawers are characterised by a thin thickness of only 8 mm and the exclusive "folding" processing without joints on the edges.

IT Il progetto Cover si aggiorna con un programma di cassettiere modulari e componibili, realizzate con le più recenti tecnologie produttive per la lavorazione dell'alluminio estruso: i cassetti sono caratterizzati dallo spessore sottile di soli 8 mm e dall'esclusiva lavorazione "folding" senza giunzioni sugli spigoli.

DE Das Cover-Projekt wird mit einem Programm von Schubladenelementen aktualisiert, die mit den neuesten Produktions-technologien für die Verarbeitung von stranggepresstem Aluminium hergestellt sind: Die Schubladen zeichnen sich durch eine geringe Dicke von nur 8 mm und die exklusive „Folding“-Verarbeitung ohne Fugen an den Kanten aus.

FR Le projet Cover est renouvelé avec un programme de meubles tiroirs modulables, réalisés avec les technologies de production les plus récentes pour le traitement de l'aluminium extrudé: les tiroirs se caractérisent par une épaisseur fine de seulement 8 mm et le travail de "pliage" sans joints sur le bords.

ES El proyecto Cover se actualiza con un programa de cajoneras modulares y componibles, realizadas con las últimas tecnologías productivas para la elaboración del aluminio extruido: los cajones se caracterizan por un fino espesor de solo 8 mm y el exclusivo proceso "folding" sin juntas en los bordes.

RU Проект Cover обновлен программой модульных и секционных ящиков, изготовленных с использованием новейших технологий обработки экструдированного алюминия: ящики отличаются толщиной всего 8 мм и уникальной бесшовной «складной» обработкой краев.

汉语 Cover 的设计更新至模块化的组合抽屉柜方案, 以最新的挤出铝合金工艺生产技术完成: 以仅 8 毫米厚的抽屉为特色, 搭配独家“折弯”技术, 不再需要为家具的边角使用连接件。

Cover, Cover freestanding, Cover open

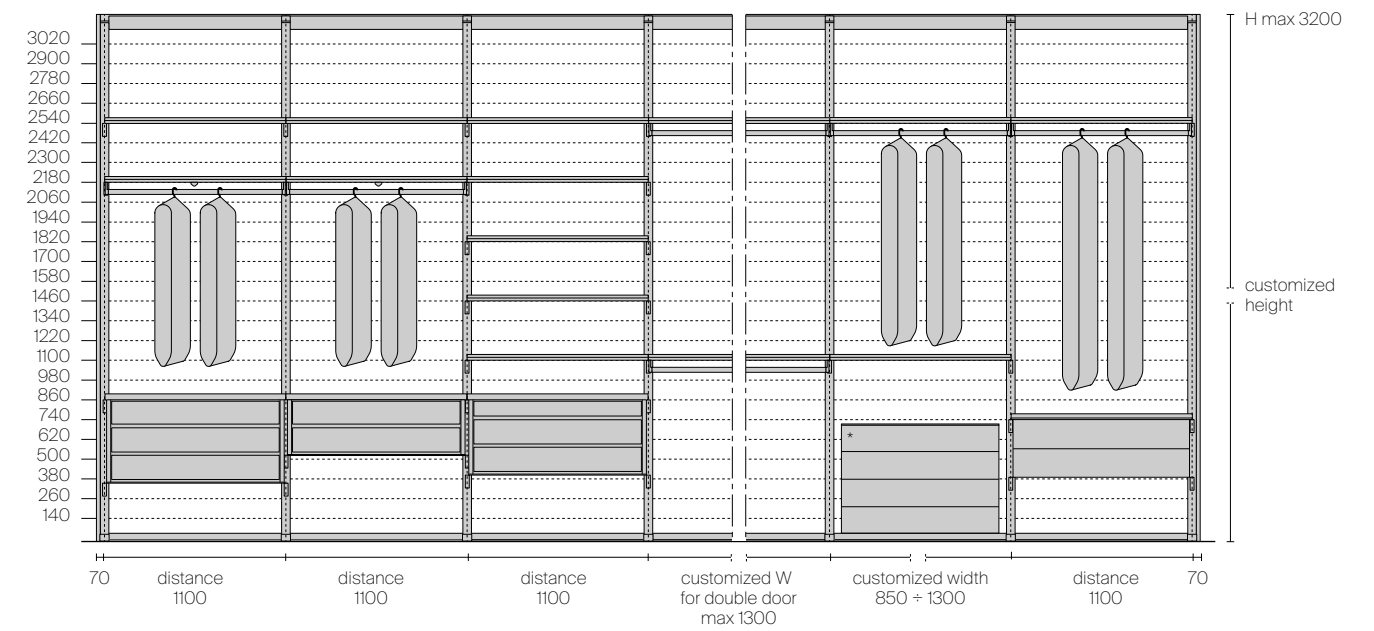

* drawer units are not available in customized dimension

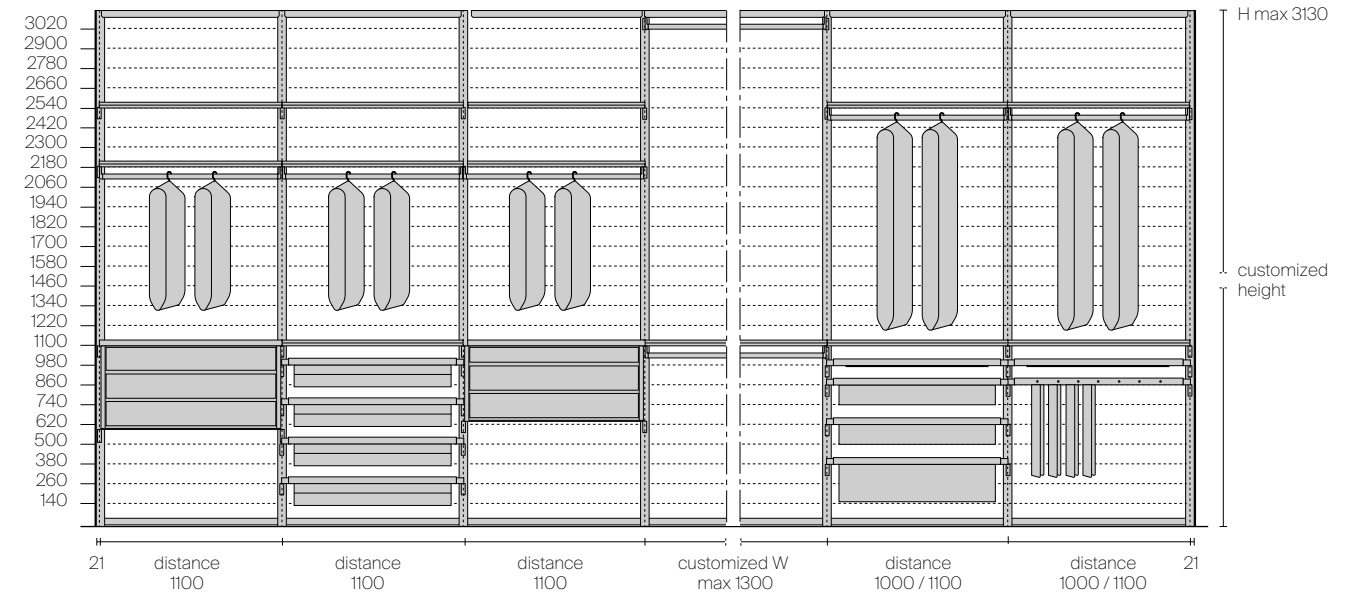

Transparent glass top, 3 drawers with glass front. Synthetic leather internal drawer cladding.



Transparent glass top, 1 drawer with glass front, 2 drawers with open fronts. Fabric internal drawer cladding.



Top, fronts and internal drawer cladding in synthetic leather



Transparent glass top, 1 drawer with glass front, 2 drawers with aluminium fronts. Synthetic leather internal drawer cladding.



SUSPENDED DRAWER UNITS

H 377 with 2 drawers

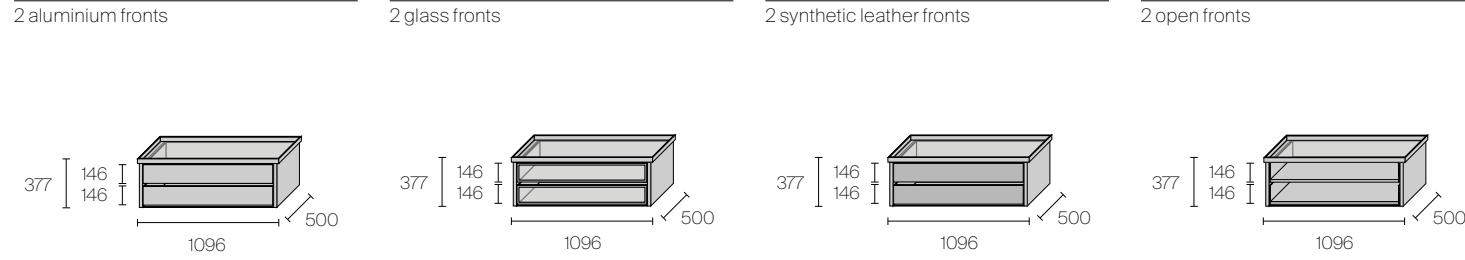

1 glass front, 1 aluminium front	1 glass front, 1 open front	1 glass front, 1 synthetic leather front
----------------------------------	-----------------------------	--

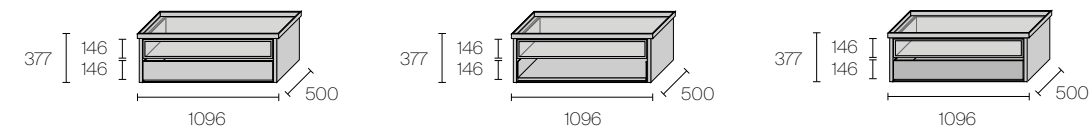

H 492 with 3 drawers

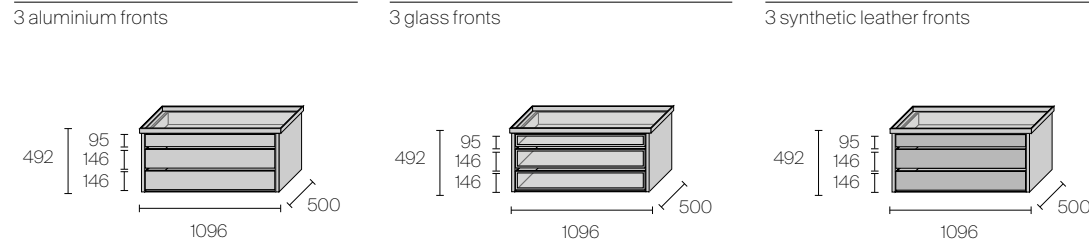

1 glass front, 2 with aluminium fronts	1 glass front, 2 open fronts	1 glass front, 2 synthetic leather fronts
--	------------------------------	---

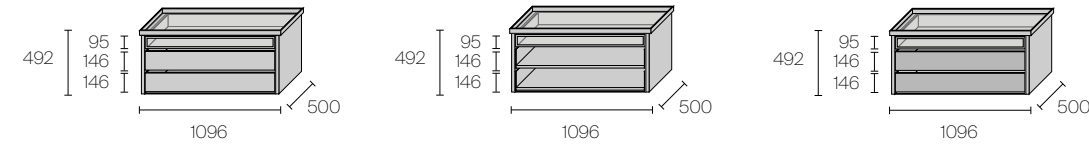

H 543 with 3 drawers

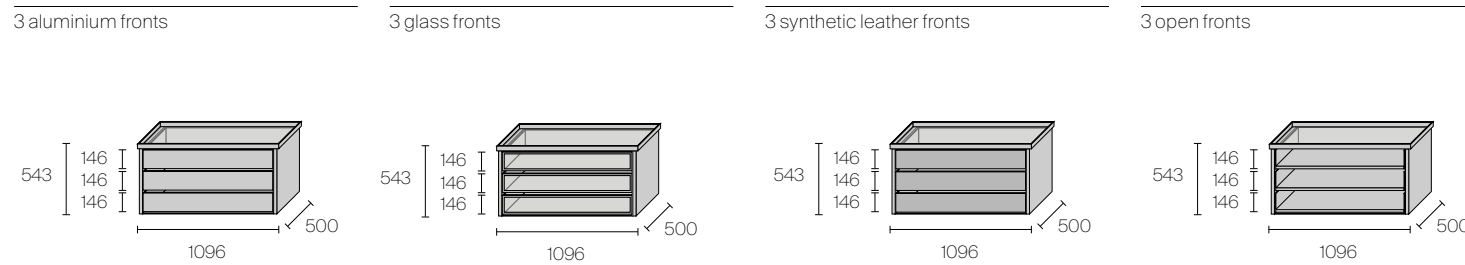

1 glass front, 2 aluminium fronts	1 glass front, 2 open fronts	1 glass front, 2 synthetic leather fronts
-----------------------------------	------------------------------	---

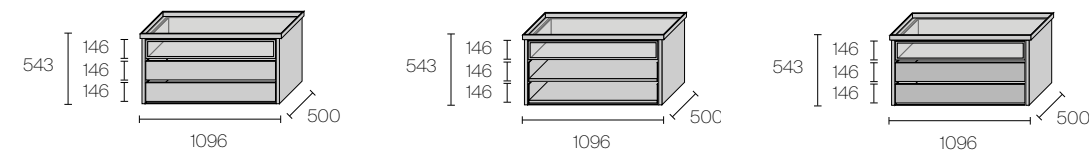

ACCESSORIES

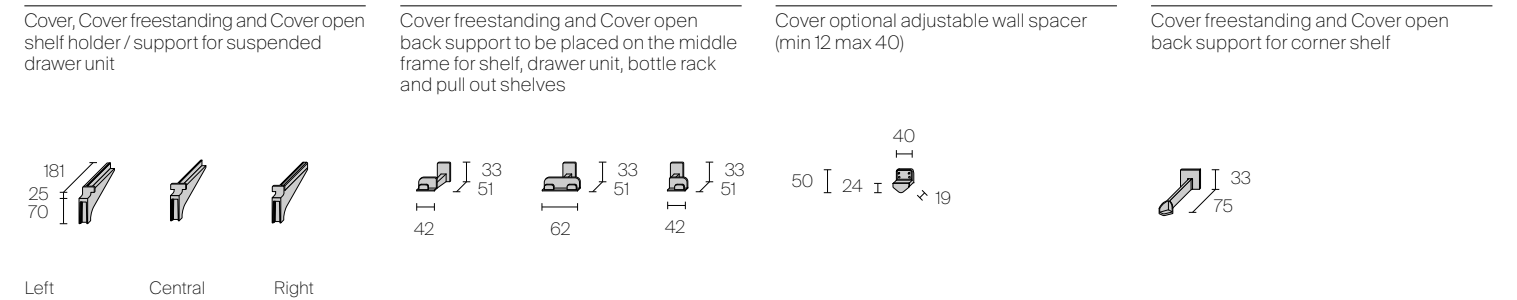
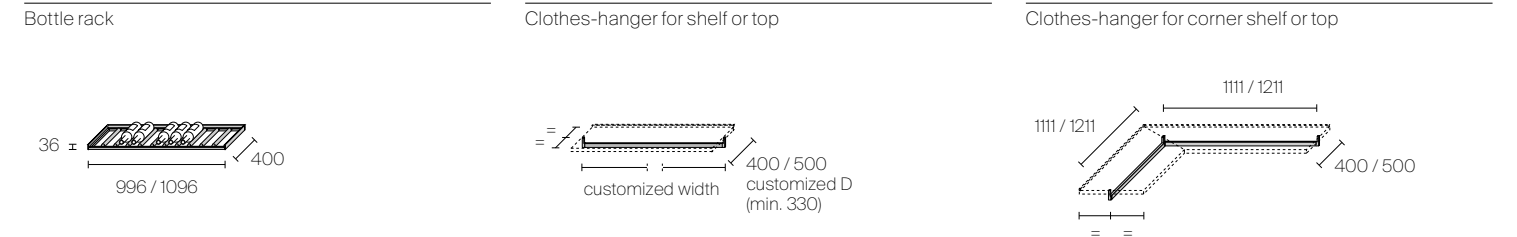
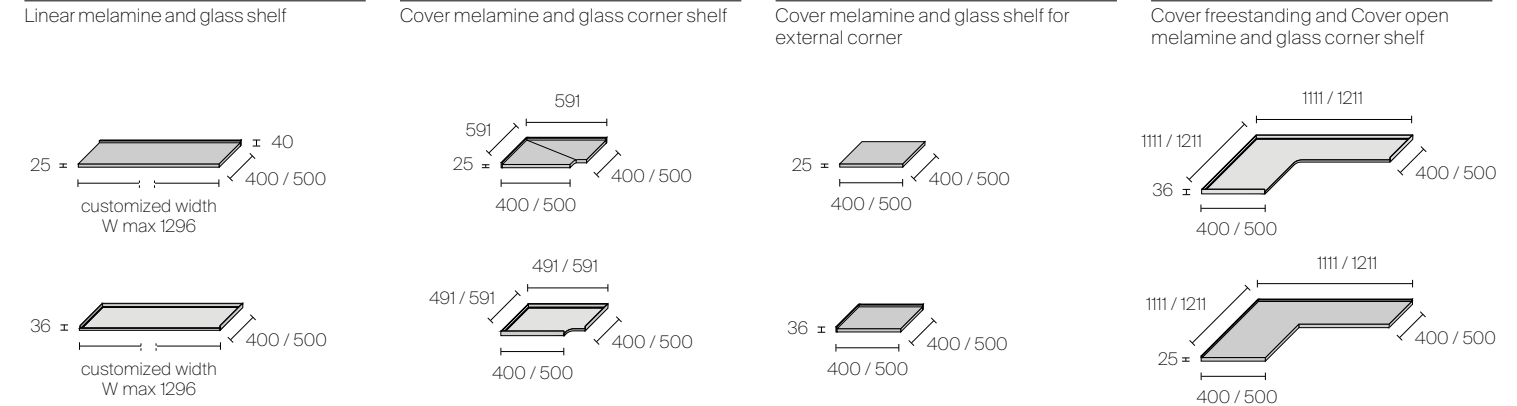
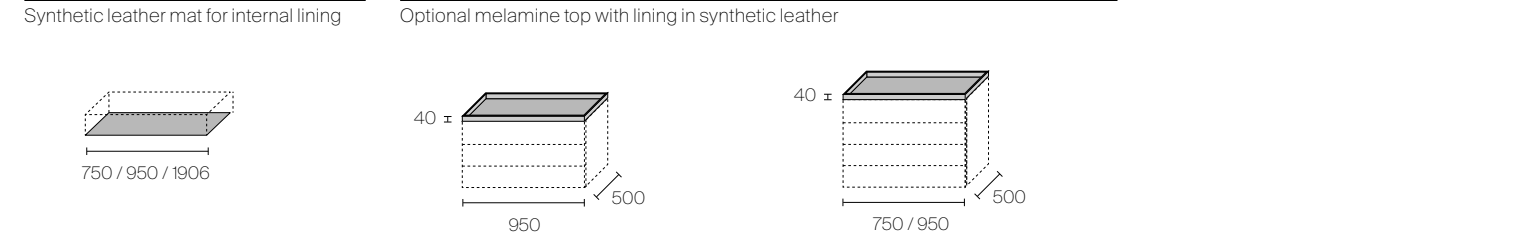
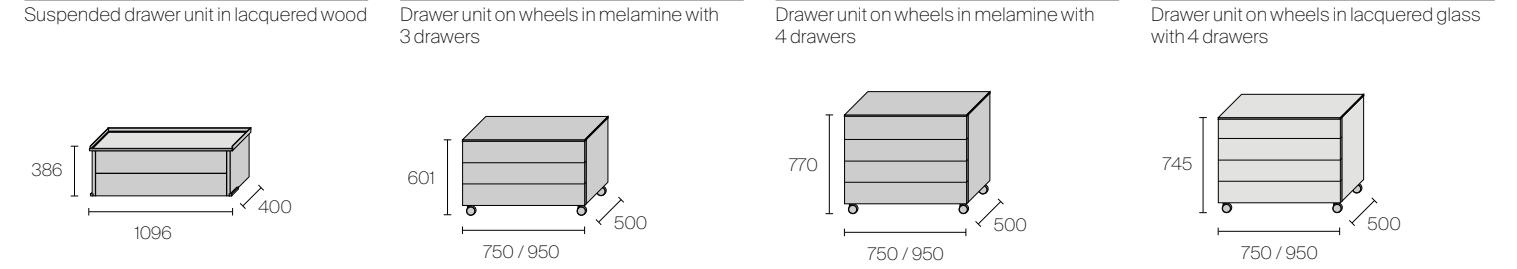
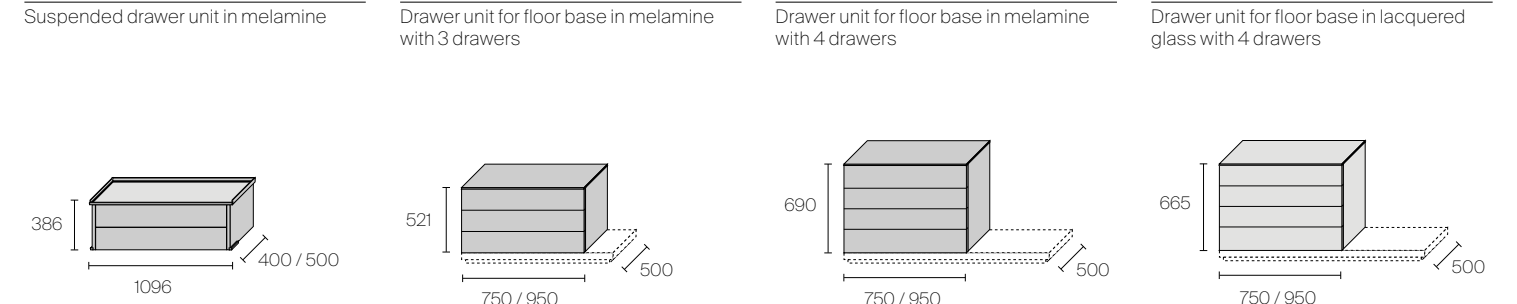



1



2

1. Melamine shelf
2. Melamine drawer unit for floor base
3. Pull-out shelf with tray in synthetic leather
4. Pull-out shelf with tie rack in synthetic leather
5. Pull-out shelf with shoes rack in synthetic leather
6. Synthetic leather cabinets on wheels



3



4



5



6



1



2



3



4

1. Glass shelf covered with synthetic leather
2. Suspended drawer unit in melamine with synthetic leather top
3. Pull-out shelf with organizer in lacquered wood and tray in synthetic leather
4. Pull-out shelf with trousers rack and belt tray in synthetic leather
5. Small pull-out tray in synthetic leather
6. Big pull-out tray in synthetic leather



5



6



1



2



3



4



5



6

1. Proposal B with accessories inside the organizer:
3 veneered organizers, 1 organizer with double partition, 1 watch holder, 2 concave boxes
2. Proposal B with accessories outside the organizer:
3 veneered organizers, 1 organizer with double partition, 1 watch holder
3. Proposal A with accessories outside the organizer:
3 veneered organizers, 2 organizers with double partition, 1 concave box, 1 box with jewels slot
4. Proposal A with accessories inside the organizer:
3 veneered organizers, 2 organizers with double partition, 1 concave box, 1 box with jewels slot
5. Synthetic leather box
6. Synthetic leather tray

Pull-out shelf with organizer tray in lacquered wood and tray in synthetic leather

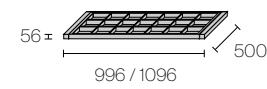

Pull-out shelf with tie rack in synthetic leather

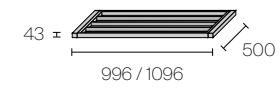

Pull-out shelf with trousers rack and belt tray in synthetic leather with 11/13 extractable rods

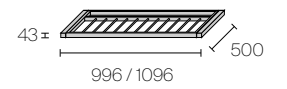

Pull-out small tray in synthetic leather

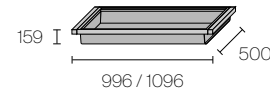

Pull-out big tray in synthetic leather

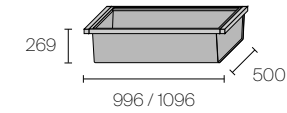

Pull-out shelf with shoes rack in synthetic leather

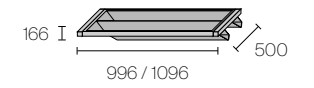

Pull-out shelf with tray in synthetic leather

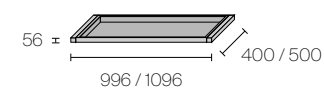

Veneered organizer

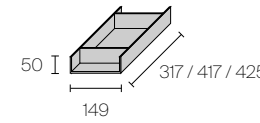

Organizer with double partition in synthetic leather

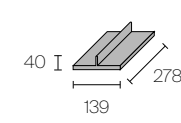

Watch holder in synthetic leather

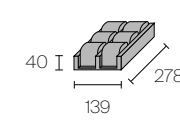

Box with jewels slots and concave box in synthetic leather

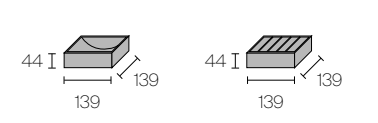

Synthetic leather box

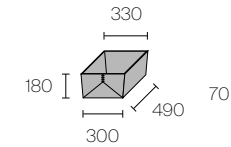

Synthetic leather tray

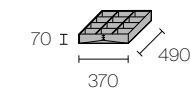

Synthetic leather cabinet on wheels

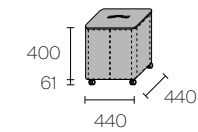

Wooden clothes hanger



Structural crosspiece, structural upright, back side filler and upper back filler, shelf holder

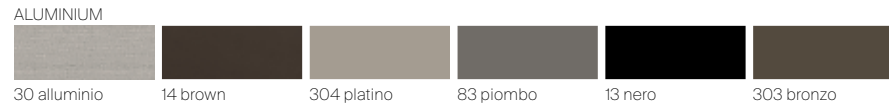

Ceiling adjusting profile

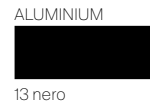

Structural upright for external corner, front side filler, upper front filler, terminal panel structure, swing door structure

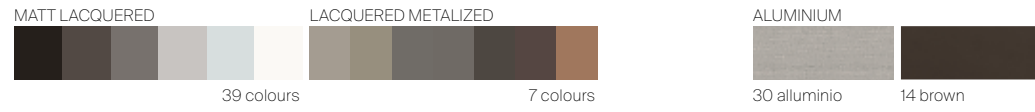

Floor base and top



Cover freestanding and Cover open back panel

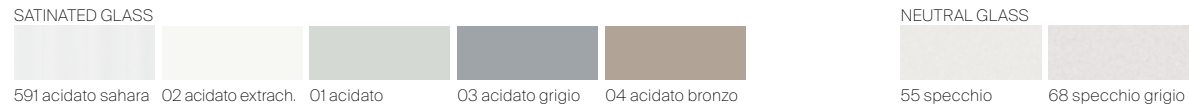

Cover terminal panel, Cover freestanding and Cover Open side panels

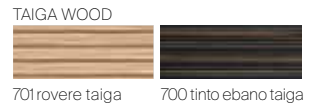
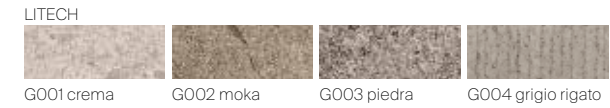
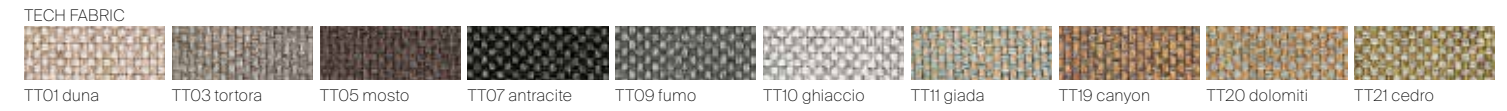
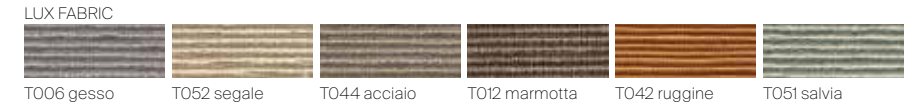
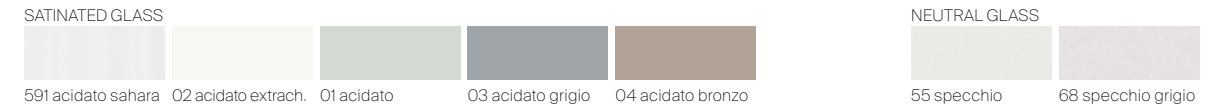
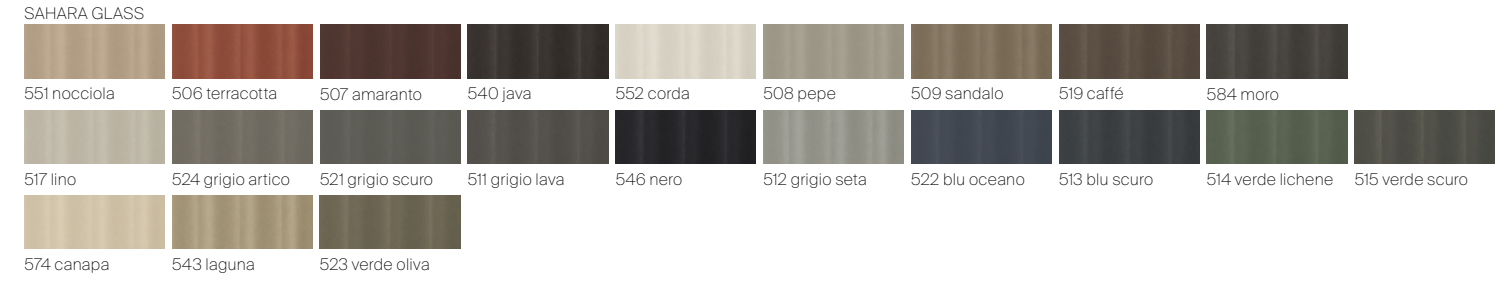

* not available for Cover

Single glass swing door

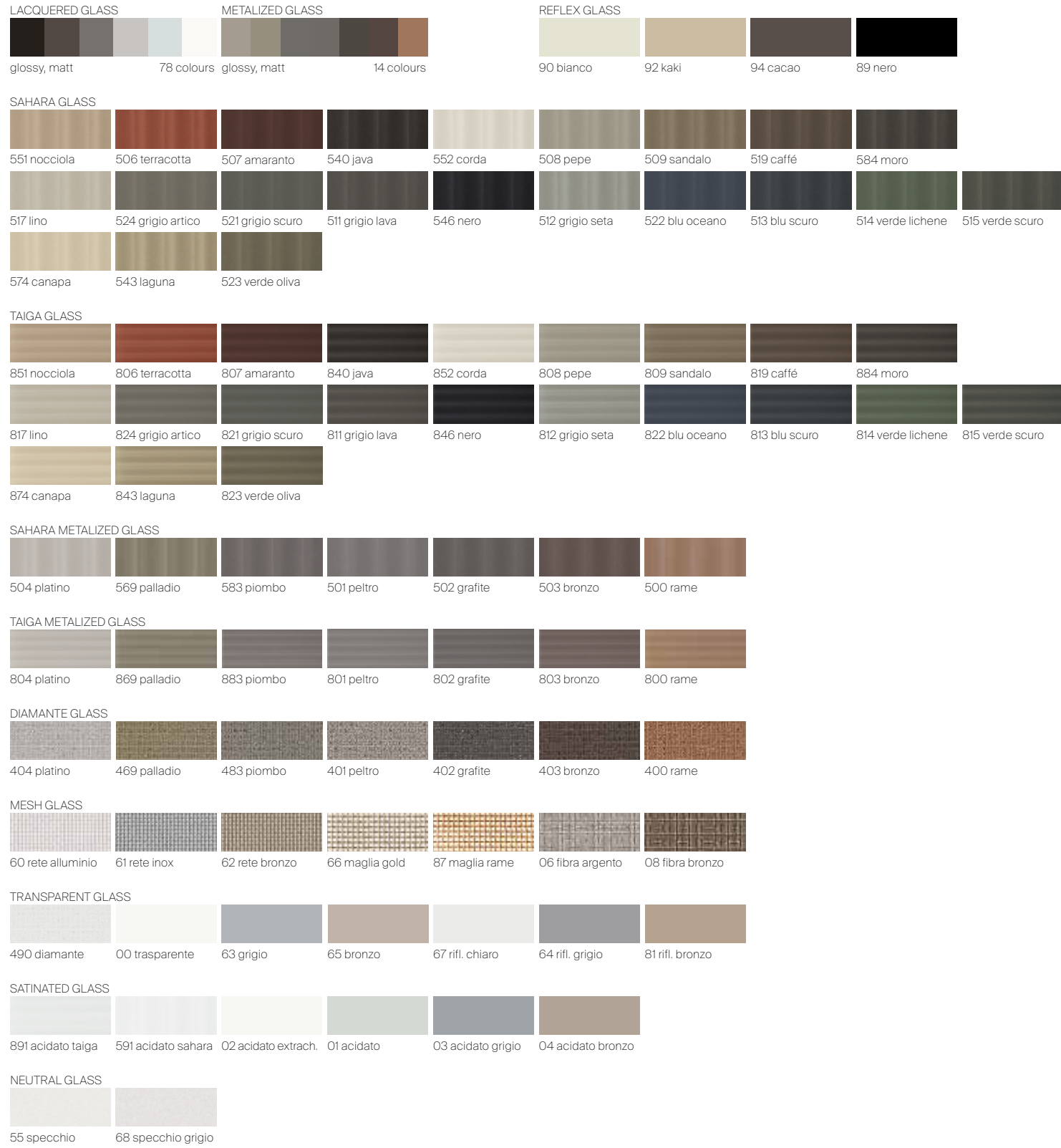

Double finished swing door



FINISHINGS

Shelf

TRANSPARENT GLASS



SATINATED GLASS

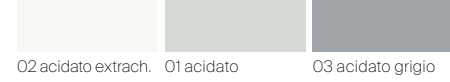

SYNTHETIC LEATHER

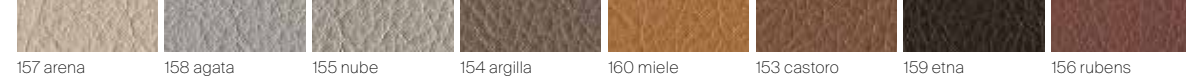

MELAMINE



Bottle rack

ALUMINIUM

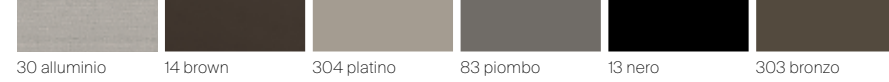

MELAMINE



Drawer units for floor base of on wheels

LACQUERED GLASS METALIZED GLASS



DIAMANTE GLASS



MELAMINE



Pull-out shelf, clothes-hanger for shelf, mat for internal lining

SYNTHETIC LEATHER



Suspended drawer units with aluminium drawers

MATT LACQUERED



LACQUERED METALIZED



ALUMINIUM

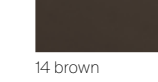

TRANSPARENT GLASS



SYNTHETIC LEATHER

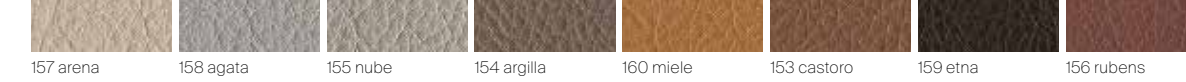

Drawer internal cladding

SYNTHETIC LEATHER

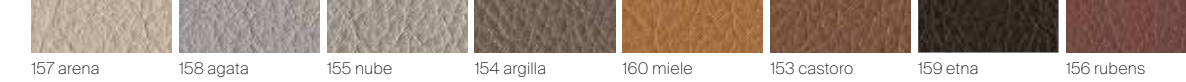

MATERIAL FABRIC



LUX FABRIC

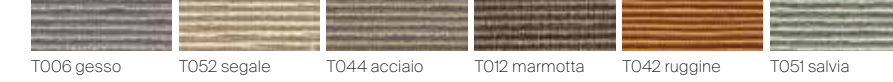

TECH FABRIC



Suspended drawer units in lacquered wood or melamine

MATT LACQUERED



LACQUERED METALIZED



ALUMINIUM

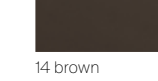

MELAMINE



Internal drawer unit

INTERNAL MELAMINE



VANITY

158 VANITY

VANITY



A CORNER DEDICATED TO SELF-CARE, DESIGNED TO HOLD PRECIOUS BELONGINGS, COSMETICS AND FRAGRANCES: THE VANITY SOLUTION IS CUSTOM-MADE IN TERMS OF BOTH HEIGHT AND DEPTH, SPECIALLY DESIGNED TO INTEGRATE WITH THE RIMADESIO CLOSET SYSTEMS.

IT Un angolo dedicato alla cura di sé, pensato per custodire preziosità, cosmesi e fragranze profumate: Vanity è appositamente studiato per integrarsi con i sistemi armadio della collezione Rimadesio grazie a una realizzazione sempre su misura in altezza e profondità.

DE Eine Ecke, die der Selbstpflege gewidmet ist und für die Aufbewahrung von kostbaren Essenzen, Kosmetika und Parfüms konzipiert wurde: Vanity wurde speziell für die Integration in die Schranksysteme der Rimadesio-Kollektion konzipiert und lässt sich in Höhe und Tiefe in Maßanfertigung anpassen.

FR Un coin beauté dédié à soi, conçu pour abriter objets précieux, cosmétiques et parfums: Vanity a été spécialement conçu pour s'intégrer aux placards de la collection Rimadesio, grâce à une réalisation toujours sur-mesure, tant en hauteur qu'en profondeur.

ES Un rincón dedicado al cuidado personal, pensado para guardar objetos preciosos, cosméticos y fragancias perfumadas: Vanity está especialmente diseñado para integrarse con los sistemas de armarios de la colección Rimadesio gracias a su altura y profundidad personalizadas.

RU Уголок для ухода за собой, предназначенный для хранения драгоценностей, косметики и духов: Vanity специально разработан для интеграции с гардеробными системами коллекции Rimadesio благодаря индивидуально подобранной высоте и глубине.

汉语 专为个人保养，存放贵重物品、美妆品和香氛设计而成的一方空间：Vanity 专为与 Rimadesio 系列衣柜系统结合研发而成，其高度和深度皆按照尺寸定制。



Structure: 83 piombo
Top, lower back panel and storage unit:
19 rovere termotrattato
Sides and back panel in material fabric: T019 papiro
Sliding door: 55 specchio

In this photo
Storage system: Cover freestanding

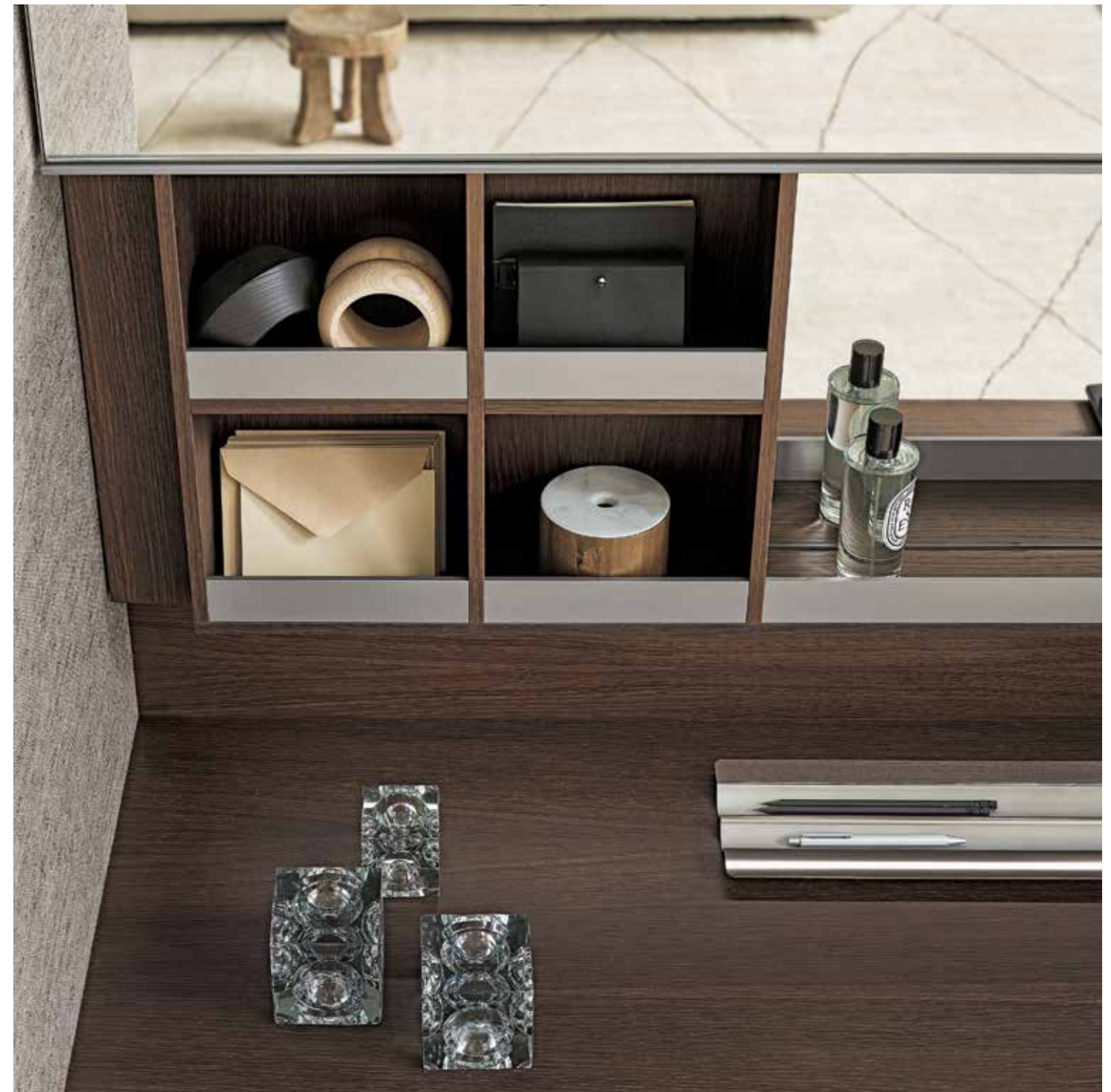

Structure: 83 piombo
Top, lower back panel and storage unit:
19 rovere termotrattato
Sides and back panel in material fabric: T019 papiro
Sliding door: 55 specchio



Structure: 303 bronzo
Top, lower back panel and storage unit: 15 noce
Glass shelves: 63 grigio trasparente
Sides and back panel in material fabric: T003 brandy
Internal mirror and sliding door: 55 specchio

EN The cabinets alternate with the wall paneling system in a linear and coherent design, emphasized by the exclusive materiality of the diamante glasses. Integrated into the wall, the storage elements allow to organize spaces rationally. Always made-to-measure in height and width, it is completely customizable in accessories, finishings and materials.

IT I contenitori si alternano ai pannelli boiserie in un progetto lineare e coerente, scandito dall'esclusiva matericità dei vetri diamante. Integrati nella parete a effetto continuo, gli elementi guardaroba consentono di organizzare razionalmente lo spazio. Un sistema sempre su misura in altezza e larghezza, completamente personalizzabile in attrezzature, finiture e materiali.

DE Die Behälter wechseln sich mit den Holz-Paneelen in einem linearen und zusammenhängenden Projekt ab, das durch die exklusive Materialität den Glaeser Diamante gekennzeichnet ist. Die in die durchgehende Effektwand integrierten Kleiderschränkelemente ermöglichen eine rationelle Organisation des Raums. Ein System, das immer auf Höhe und Breite zugeschnitten ist und in Bezug auf Ausstattung, Oberflächen und Materialien vollständig anpassbar ist.

FR Les compartiments et les panneaux boiserie sont disposés en alternance dans un projet linéaire et cohérent, marqué par la matière exclusive des verres diamante. Intégrés dans le panneau mural à effet continu, les éléments dressing permettent d'organiser l'espace de manière rationnelle. Un système toujours sur mesure en hauteur et largeur, dont les équipements, finitions et matériaux peuvent être entièrement personnalisés.

ES Los contenedores se alternan con los paneles de la boiserie en un proyecto lineal y coherente, marcado por la exclusiva materialidad de los cristales diamante. Integrados en la pared con efecto continuo, los elementos del vestidor permiten organizar de manera racional el espacio. Un sistema siempre a medida en altura y anchura, con equipamiento, acabados y materiales completamente personalizables.

RU Шкафы для хранения чередуются с панелями буазери в линейном и целостном дизайне, отмеченного уникальной текстурой стекла diamante. Встроенные в стену, создавая эффект непрерывности, элементы гардероба позволяют рационально организовать пространство. Система, всегда подгоняемая по высоте и ширине, полностью адаптируется по оснащению, отделке и материалам.

汉语 储物柜可与多块护壁板交错配置,具流畅的线性设计,并以独家的各式 Diamante 玻璃为标志性特色。嵌入式的衣柜部件展现出连续性的效果,取得空间的合理组织性。这套系统的高度和宽度皆按尺寸定制,其配件、表面处理和材质可完全个性化制作。

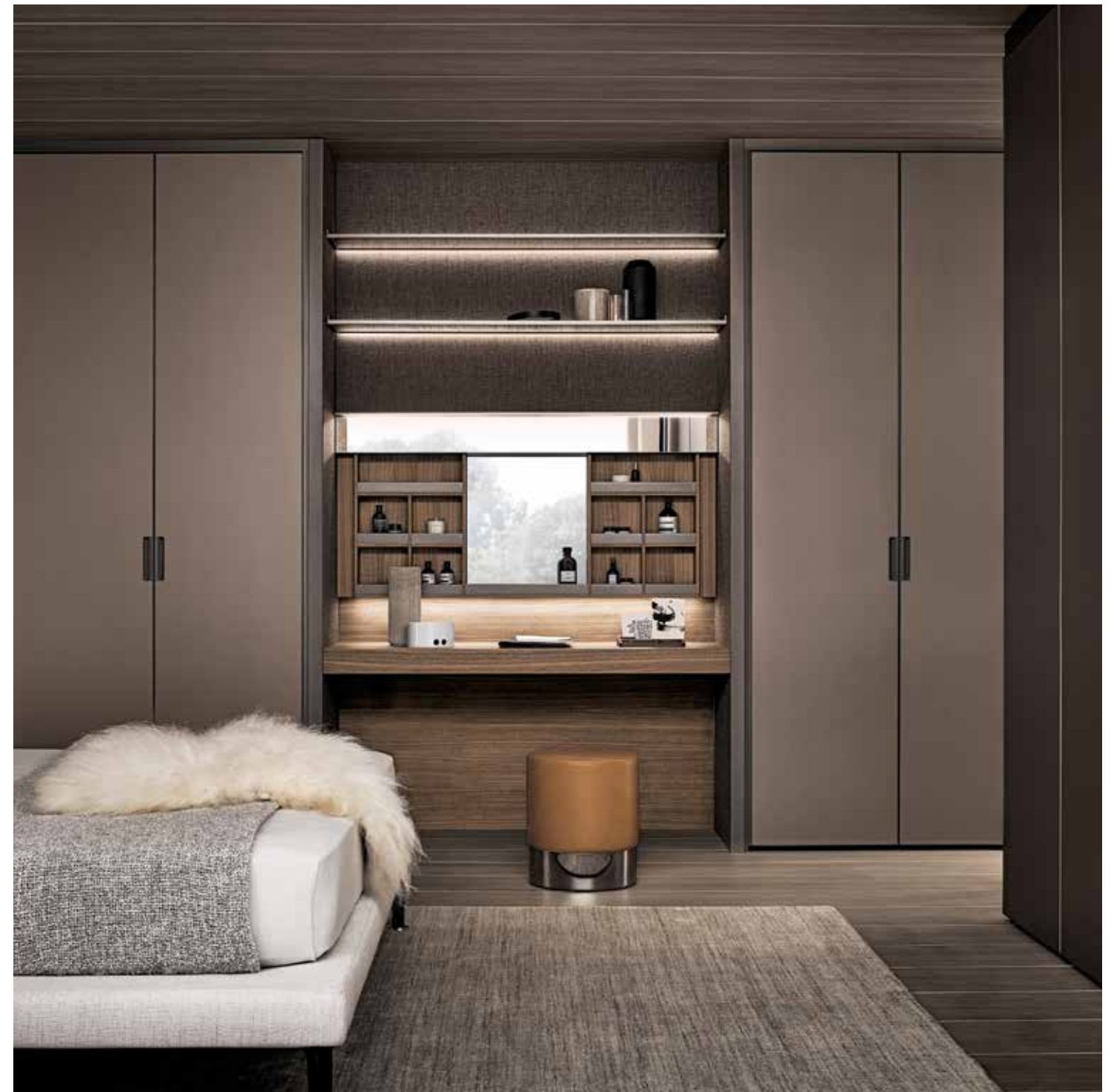

Structure: 303 bronzo
Top, lower back panel and storage unit: 15 noce
Glass shelves: 63 grigio trasparente
Sides and back panel in material fabric: T003 brandy
Internal mirror and sliding door: 55 specchio

EN Vanity is designed to perfectly integrate with the Rimadesio walk-in and storage systems thanks to its design which is always custom made in height and depth. It provides a countertop in wood and a composition of storage compartments which can be hidden thanks to a mirror-coated door equipped with vertical sliding. The beauty corner also includes two top glass shelves, the internal mirror and an optional led system enhancing volumes and surfaces.

IT Vanity è appositamente studiato per integrarsi con i sistemi armadio della collezione Rimadesio grazie a una realizzazione sempre su misura in altezza e profondità. Prevede un piano d'appoggio in essenza e una composizione di vani portaoggetti occultabile grazie a un'anta rivestita a specchio e dotata di scorrimento verticale. Completano l'angolo beauty i due ripiani superiori in vetro, la specchiera interna e un sistema led opzionale che esalta volumi e superfici.

DE Vanity wurde speziell für die Integration in die Garderobensysteme der Rimadesio-Kollektion entwickelt mit einer Umsetzung, die stets auf Höhen und Tiefen zugeschnitten ist. Es verfügt über eine hölzerne Auflagefläche und eine verdeckbare Aufbewahrungsfachzusammensetzung dank einer spiegelbeschichteten vertikalen Schiebetür. Die beiden oberen Glasböden, der Innenspiegel und ein optionales LED-System zur Verbesserung von Volumen und Oberflächen vervollständigen die Beauty-Ecke.

FR Vanity est expressément étudié pour s'intégrer dans les systèmes de placards de la collection Rimadesio, grâce à une réalisation toujours sur mesure en hauteur et profondeur. Il comprend un plan d'appui en bois et une composition de compartiments porte-objets occultable au moyen d'un panneau miroir coulissant verticalement. Deux tablettes supérieures en verre complètent le coin beauté, le miroir intérieur et un système optionnel qui met en valeur les volumes et les surfaces.

ES Vanity ha sido especialmente estudiado para integrarse con los sistemas armario de la colección Rimadesio, gracias a una realización siempre a medida de la altura y la profundidad. Cuenta con un top de apoyo de madera y una composición de huecos portaobjetos ocultable, gracias a una puerta revestida con espejo que se desliza verticalmente. Completan el rincón de belleza los dos estantes superiores de cristal, el espejo interno y un sistema led opcional que enfatiza volúmenes y superficies.

RU Vanity специально разработана для установки в гардеробные системы коллекции Rimadesio благодаря индивидуально подобранной высоте и глубине. Она оснащена столешницей из натурального дерева и композицией потайных отделений для хранения благодаря зеркальной дверцей, оснащенной механизмом вертикального скольжения. Завершают уголок красоты две верхние стеклянные полки, внутреннее зеркало и дополнительная светодиодная подсветка, подчеркивающая объемы и поверхности.

汉语 Vanity 专为与 Rimadesio 系列衣柜系统结合研发而成，其高度和深度皆按照尺寸定制。支撑台面由木材打造，镜面的纵向滑动移门创造出隐藏式的储物空间组合。上部的两层玻璃隔板、内侧美妆镜以及选配的 LED 照明系统完善了这个梳妆空间，着重容量和表面。

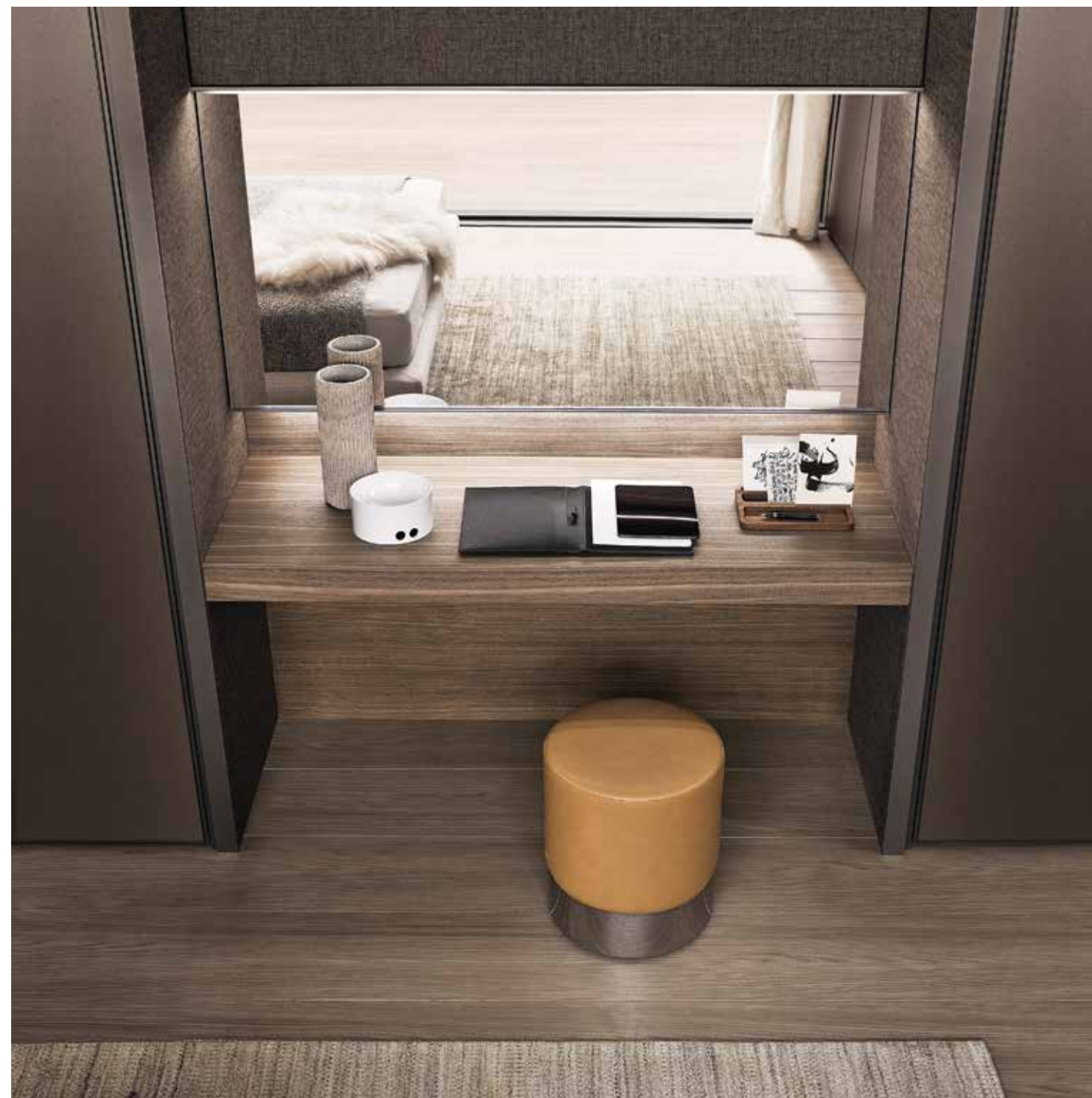

Structure: 303 bronzo
Top, lower back panel and storage unit: 15 noce
Glass shelves: 63 grigio trasparente
Sides and back panel in material fabric: T003 brandy
Internal mirror and sliding door: 55 specchio

DIMENSIONS

Version with vertical sliding door with mirror and cabinet with storage units

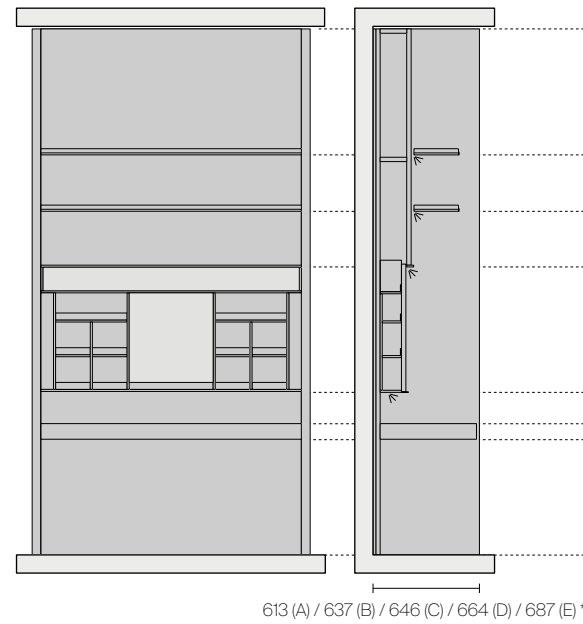

Version with fixed mirror

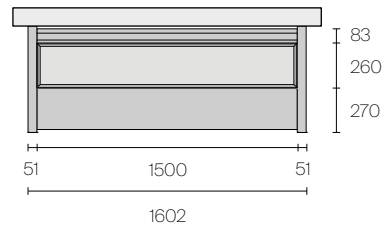
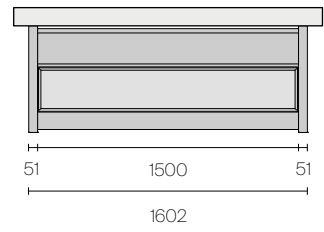
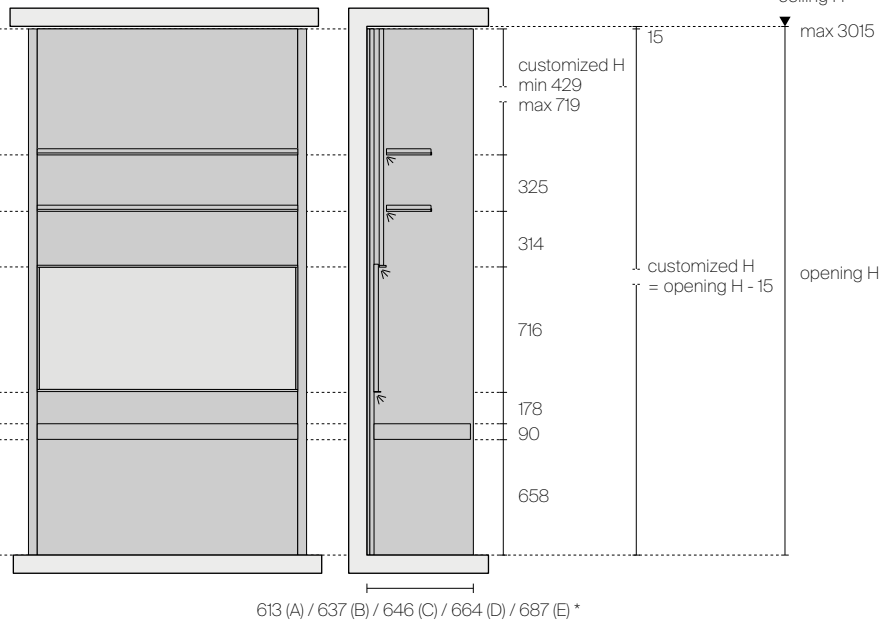

- * A= Cover, Dress, Abacus, Zenit
- B= Cover open
- C= Cover with terminal glass panel
- D= Cover freestanding
- E= Modulor storage

TECHNICAL DESCRIPTION

EN Vanity can be positioned within linear, internal and external corner composition, or as an end unit. The version with a vertical sliding door is equipped with storage compartments that can be hidden behind the mirrored door. Alternatively, there is a version with a fixed mirror. The LED lighting system is optional.

IT Vanity è un elemento posizionabile in composizioni lineari, ad angolo interno, esterno o come elemento terminale. La versione con anta scorrevole è dotata di vani portaoggetti occultabili grazie a un'anta rivestita a specchio e dotata di scorrimento verticale. In alternativa è prevista la versione con specchio fisso. Opzionale il sistema di illuminazione led.

DE Vanity ist ein Element, das in linearen Kompositionen, an einer inneren oder äußeren Ecke oder als Abschlusselement platziert werden kann. Die Version mit Schiebetürblatt ist dank einer verspiegelten, vertikal verschiebbaren Tür mit verdeckten Ablagefächern ausgestattet. Alternativ gibt es auch eine Version mit einem festen Spiegel. Optionales LED-Beleuchtungssystem.

FR Vanity est un élément modulable selon des compositions linéaires, dans un coin intérieur, extérieur ou comme élément final. La version avec porte coulissante est équipée de compartiments de rangement qui peuvent être cachés grâce à une porte miroir à coulissement vertical. En alternative, une version à miroir fixe est disponible. Le système d'éclairage LED est proposé en option.

ES Vanity es un elemento que puede colocarse en composiciones lineales, en un rincón interior o exterior o como elemento de acabado. La versión con puerta corredera está equipada con compartimentos portaobjetos que se pueden ocultar gracias a una puerta espejo con corredera vertical. Como alternativa, está disponible la versión con espejo fijo. El sistema de iluminación LED es opcional.

RU Vanity — это элемент, который может быть размещен в линейных композициях, во внутреннем или внешнем углу или в качестве завершающего элемента. Версию со скользящей вертикально зеркальной дверью оснащена скрытыми отделениями для хранения. Кроме того, есть версия с неподвижным зеркалом. Под заказ устанавливается система светодиодного освещения.

汉语 Vanity 为一款可置于线性、内转角和外转角或作为末端组合件的家具部件。这个版本采用镜面的上下滑动推拉门，创造出隐藏式的储物空间组合。另有固定镜面的版本可供选择。可选配 LED 照明系统。

POSSIBLE COMPOSITION

Vanity freestanding

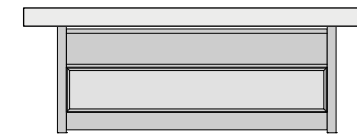

Linear composition with central Vanity for Cover, Cover freestanding, Dress Bold, Abacus



Linear composition with terminal Vanity for Cover, Cover freestanding, Dress Bold, Abacus



Composition with internal corner for Dress Bold, Abacus

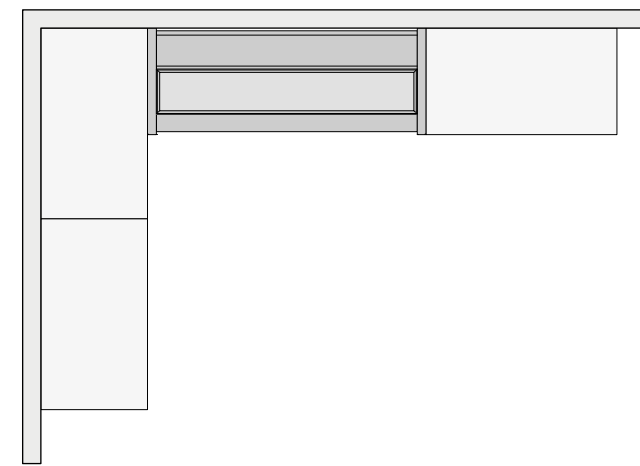

Composition with internal corner for Cover, Cover freestanding

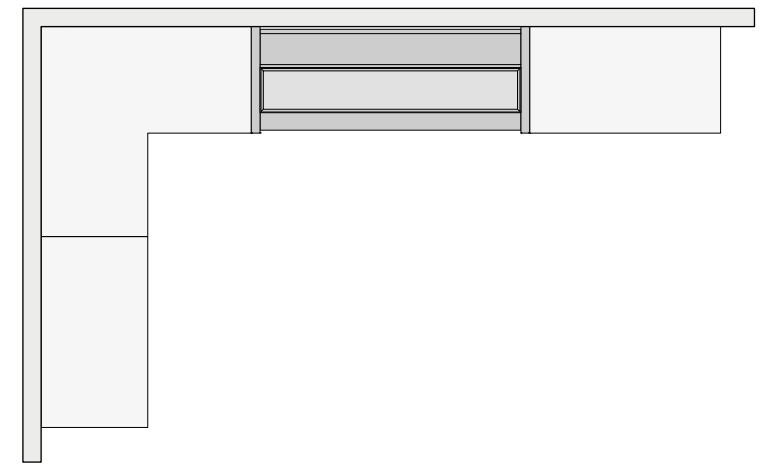

Composition with external corner for Cover, Cover freestanding



Abacus + Vanity

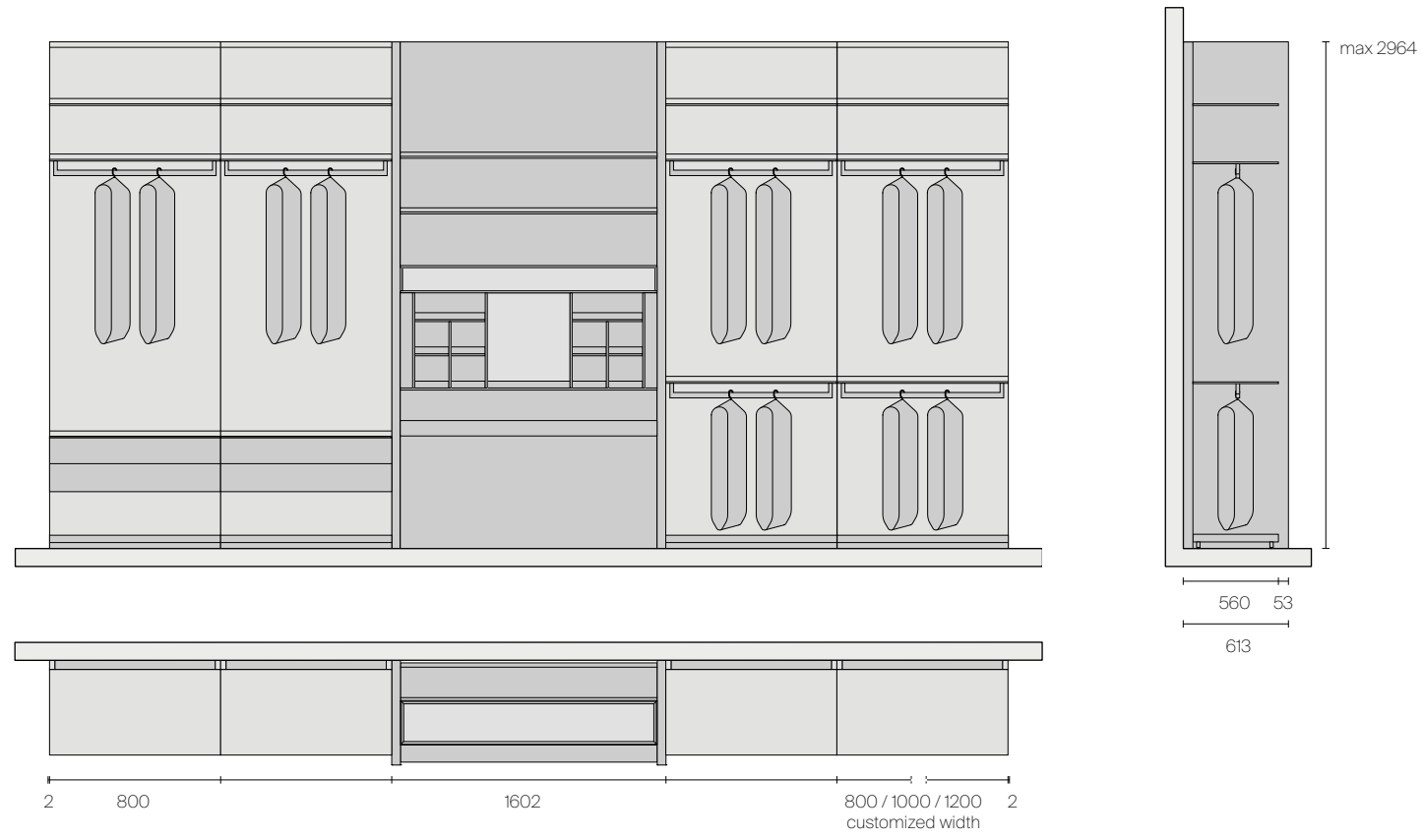

Cover freestanding + Vanity

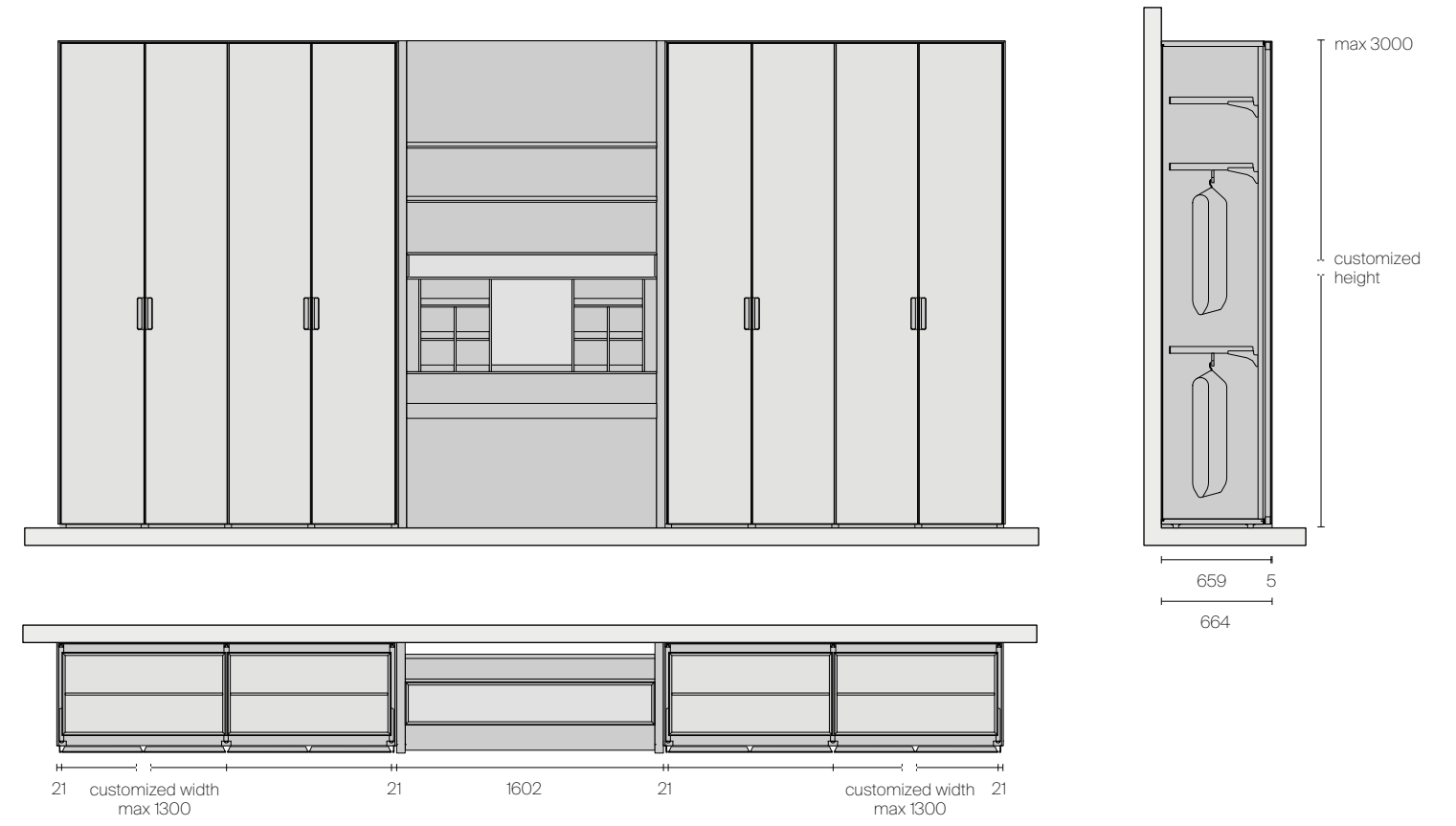

Dress Bold + Vanity

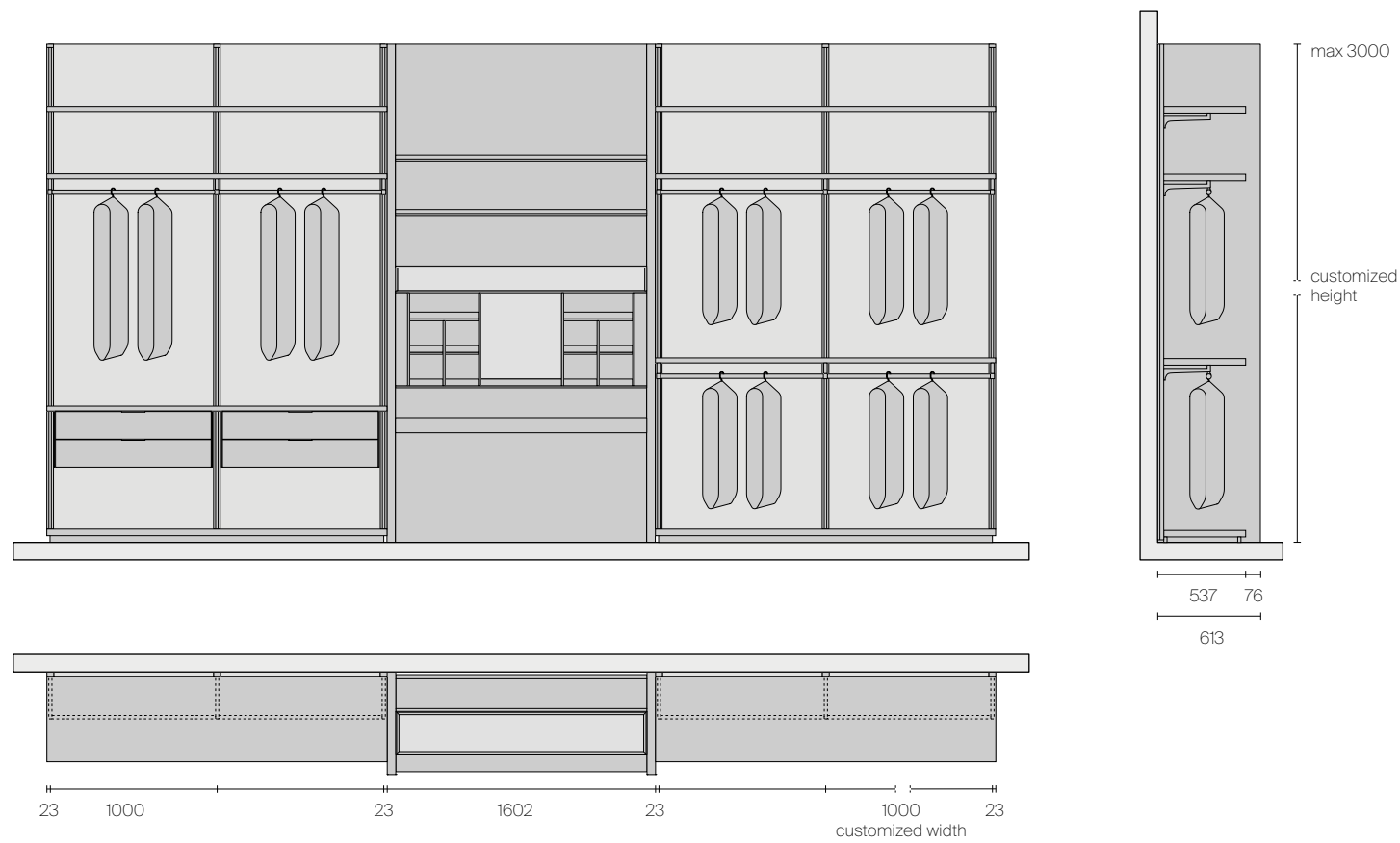

Cover + Vanity



Material fabric cladding



Lux fabric cladding



Tech fabric cladding



Synthetic leather cladding



Mat glass cladding



Litech cladding



Storage unit, top and back panel in 15 noce



Storage unit, top and back panel in 19 rovere termotrattato



TECHNICAL DESCRIPTION

EN Thanks to the wide range of materials and finishes, Vanity can be perfectly integrated into the Rimadesio closet systems: the top, the lower back panel and the storage compartments are made from wood (noce or rovere termotrattato). The aluminium components on the uprights, as well as the profiles of the containers and the upper shelves, are available in the entire Ecolorsystem colour range. The internal sides and the upper back panel also offer complete customisation: glossy and matt lacquered glass, diamante and reflex, Litech, fabric and synthetic leather.

IT La varietà di materiali e finiture consente una perfetta integrazione di Vanity nei sistemi armadio Rimadesio: il piano, lo schienale inferiore e i vani portaoggetti sono realizzati in essenza (noce o rovere termotrattato). Le componenti in alluminio presenti sui montanti verticali, i listelli dei contenitori e i ripiani superiori sono disponibili in tutta la gamma colori Ecolorsystem. Massima personalizzazione anche per i fianchi interni e lo schienale superiore, realizzabili in vetro laccato lucido e opaco, diamante e reflex, Litech, tessuto e similpelle.

DE Dank der Vielfalt an Materialien und Ausführungen lässt sich Vanity perfekt in die Schranksysteme von Rimadesio integrieren: Die Platte, die untere Rückwand und die Ablagefächer sind aus Holz (Noce oder Rovere Termotrattato) gefertigt. Die Aluminiumkomponenten der vertikalen Stützen, der Behälterleisten und der oberen Regalböden sind in der gesamten Ecolorsystem-Farbpalette erhältlich. Auch die Innenseiten und die obere Rückwand sind maximal anpassbar. Sie können aus glänzend und matt lackiertem Glas, Diamante- und Reflexglas, Litech, Stoff und Kunstleder hergestellt werden.

FR La variété des matériaux et des finitions permet à Vanity de s'intégrer parfaitement aux systèmes de placards Rimadesio: le plateau, le fond inférieur et les compartiments de rangement sont réalisés en bois (noce ou rovere termotrattato). Les éléments en aluminium présents sur les montants verticaux, les bandes des rangements et les tablettes supérieures sont disponibles dans toute la gamme de couleurs Ecolorsystem. Personnalisation maximale également pour les côtés internes et le fond supérieur, qui peuvent être réalisés en verre laqué brillant et mat, diamante et reflex, Litech, tissu et similicuir.

ES La variedad de materiales y acabados permite que Vanity se integre perfectamente en los sistemas de armarios Rimadesio: la tapa, el fondo inferior y los compartimentos de almacenamiento son de madera (noce o rovere termotrattato). Los componentes de aluminio presentes en los montantes verticales, las listas de los cajones y los estantes superiores están disponibles en toda la gama de colores Ecolorsystem. Máxima personalización también de los laterales internos y del fondo superior, que pueden realizarse en lacados brillante y mate cristal, diamante y reflex, Litech, tejido y simil cuero.

RU Разнообразие материалов и отделок позволяет идеально интегрировать Vanity в гардеробные системы Rimadesio: столешница, нижняя часть спинки и отсеки для хранения выполнены из дерева (орех или термообработанный дуб). Алюминиевые части вертикальных стоек, ограждения ячеек и профили верхних полок доступны во всей цветовой гамме Ecolorsystem. Максимально персонализированные внутренние стороны боковых панелей и верхняя часть спинки могут быть выполнены из глянцевого и матового лакированного стекла, diamante и reflex, Litech, ткани и эко-кожи.

双语 Vanity 具备多种材质和表面处理, 因此能与 Rimadesio 的各式衣柜系统完美结合: 以胡桃木和热处理橡木打造的台面、底部背板和储物空间。Ecolorsystem 所有的色彩系列皆可用于在垂直立柱、储物单元格柵和上部层板上的铝合金组合件。内部侧板和上部背板亦可进行最大程度的客制化, 有亮面漆和哑光漆玻璃、Diamante 和 Reflex 玻璃、Litech、布面和仿真皮革可供选择。

FINISHINGS

Structure

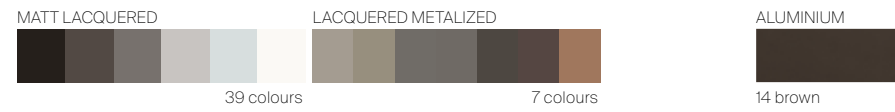

Vertical sliding door and fixed mirror



Shelves

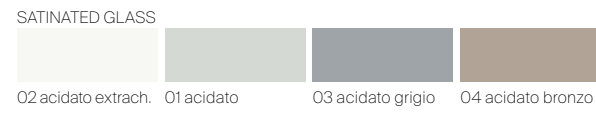
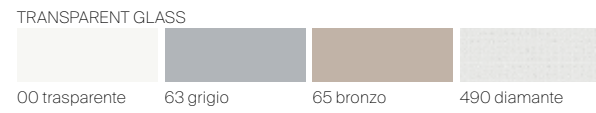

Ceiling adjustable filler

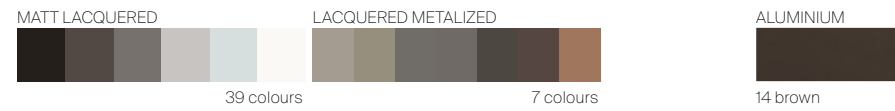

Side panels and external cladding, upper back panel

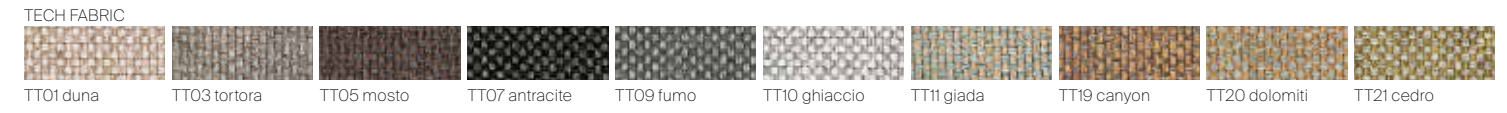
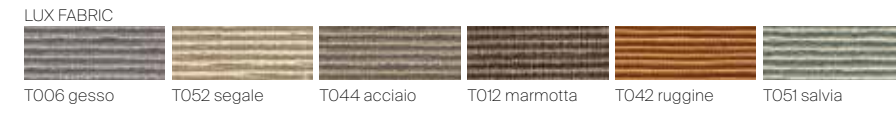
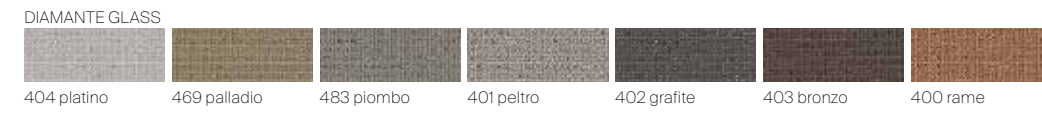
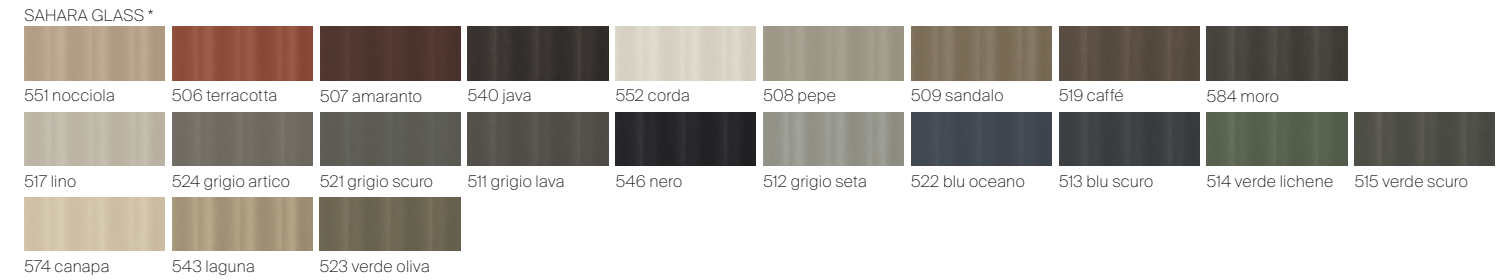
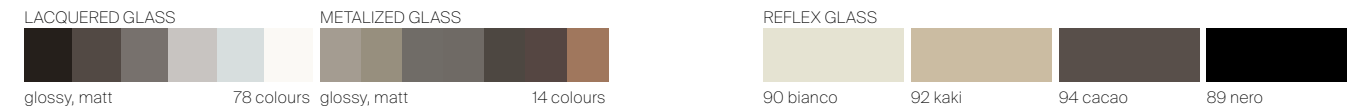

* available only for external cladding

QUALITY AS THE MAIN PURPOSE, ALWAYS AND IN EVERY ASPECT, WITH THIS MISSION RIMADESIO IS CONSTANTLY SEARCHING FOR SOLUTIONS TO IMPROVE ITS OWN ECOLOGICAL STANDARDS.

OBJECTIVE OBTAINED THANKS TO THE USE OF PRECIOUS AND RECYCLABLE MATERIALS, TO THE ABSENCE OF SUBSTANCES THAT CAN BE TOXIC TO HUMANS OR HARMFUL TO THE ENVIRONMENT IN EVERY PHASE OF THE PRODUCTIVE PROCESS, TO THE USE OF TECHNOLOGY AND EVOLVED MACHINERY, POWERED BY CLEAN ENERGY DERIVED FROM PHOTOVOLTAIC SYSTEMS, INSTALLED ON THE GIUSSANO HEADQUARTERS ROOF.

ALUMINIUM, GLASS, WOOD: FULLY RECYCLABLE AND PARTLY ALREADY RECYCLED MATERIALS.

PROOFS OF A REINFORCED GREEN DNA AND WIDE COHERENCE, SIGNALS OF A CONTINUOUS RESEARCH AND A GLANCE TOWARDS THE FUTURE, THAT TAKES SHAPE IN THE TECHNOLOGICAL INNOVATION OF SYSTEMS, DOORS AND FURNITURE, MADE WITH THE AWARENESS OF WANTING TO ENTRUST HUMANS ONLY WITH HIGH VALUE-ADDED ACTIVITIES.

EXCELLENCE SUSTAINABILITY PROJECT

IT Perseguire la qualità, sempre, sotto tutti gli aspetti. Con questa mission Rimadesio ricerca costantemente soluzioni volte a migliorare i propri standard qualitativi ecologici. Obiettivo ottenuto sinergicamente, grazie all'utilizzo di materiali preziosi e riciclabili, all'assenza di sostanze tossiche per l'uomo e nocive per l'ambiente in ogni fase del processo produttivo, all'impiego di tecnologie e macchinari evoluti alimentati con energia pulita proveniente da impianti fotovoltaici, installati sulla copertura dell'headquarter di Giussano. Alluminio, vetro, legno, materiali totalmente riciclabili e in parte già riciclati, ma anche le vernici prive di solventi di Ecoloursystem e i sistemi di imballaggio ecologici. Testimonianze di un dna green consolidato e di una coerenza trasversale, segnali di una continua attività di ricerca e di uno sguardo sempre proteso al futuro che si declina nell'innovazione tecnologica di sistemi, porte ed arredi, realizzati con la consapevolezza di voler affidare all'uomo solo attività dall'alto valore aggiunto.

DE Stets um Qualität bemüht, und zwar in allen Bereichen. Mit dieser Mission im Blick sucht Rimadesio laufend nach Lösungen, um seine ökologischen Qualitätsstandards zu verbessern. Dieses Ziel wurde dank der Verwendung wertvoller und wiederverwertbarer Materialien, dem Verzicht auf für den Menschen giftige und umweltschädliche Stoffe in jeder Phase des Produktionsprozesses und dem Einsatz fortschrittlicher Technologien und Maschinen, die mit sauberer Energie aus den auf dem Dach des Giussano-Hauptsitzes installierten Photovoltaikanlagen betrieben werden, synergetisch erreicht. Aluminium, Glas, Holz, vollständig recycelbare und teilweise bereits recycelte Materialien, aber auch die Lösungsmittelfreien Farben von Ecoloursystem und umweltfreundliche Verpackungssysteme. Ein Zeugnis einer fundierten grünen DNA und einer transversalen Kohärenz, Zeichen einer kontinuierlichen Forschungstätigkeit und eines stets in die Zukunft gerichteten Blicks, der sich in der technologischen Innovation von Systemen, Türen und Einrichtungsgegenständen ausdrückt, die in dem Bewusstsein realisiert werden, den Menschen nur Tätigkeiten mit hohem Mehrwert anzuvertrauen.

FR Poursuivre la qualité, toujours, et à tous les égards. Avec cette mission Rimadesio recherche constamment de solutions au fin d'améliorer ses normes de qualité écologique. Objectif atteint, grâce à l'utilisation de matériaux précieux et recyclables, l'absence à chaque étape de la production de substances toxiques nocives pour l'homme et l'environnement, l'utilisation de technologies et des machines avancées alimentées par l'énergie solaire après l'installation sur le toit de l'usine à Giussano de systèmes photovoltaïques. Aluminium, verre, bois, des matériaux entièrement recyclables et déjà en partie recyclés, mais aussi peinture Ecoloursystem sans solvants et systèmes d'emballage respectueux de l'environnement. Témoignages d'un adn "vert" consolidé et d'une cohérence transversale, signes de recherche continue et d'une tendance à regarder en avant, qui correspond bien à l'innovation technologique des systèmes, des portes et des meubles, réalisés avec la conscience que l'apport de l'homme dans la production ne peut qu'avoir un valeur ajoutée.

ES Perseguir la calidad, siempre, en todos los aspectos. Con esta misión Rimadesio busca constantemente soluciones destinadas a mejorar sus estándares de calidad ecológica. Objetivo conseguido sinérgicamente, gracias al uso de materiales preciosos y reciclables, a la ausencia de sustancias tóxicas para los seres humanos y nocivas para el medio ambiente en cada etapa del proceso de producción, al uso de tecnologías y máquinas avanzadas alimentadas por energía limpia a partir de sistemas fotovoltaicos, instalados en la cobertura del headquarter de Giussano. Aluminio, cristal, madera, materiales completamente reciclables y, en parte, ya reciclados, sino también las pinturas Ecoloursystem libres de disolventes y los sistemas de embalaje ecológicos. Testimonios de un adn green consolidado y una coherencia transversal, señales de una continua investigación y de una vista siempre tendida al futuro que se declina en la innovación tecnológica de sistemas, puertas y muebles, realizados con el conocimiento que desea confiar al hombre sólo actividades de alto valor añadido.

RU Обеспечение качества всегда и во всем. И, в том числе, для достижения этой цели Компания Rimadesio находится в постоянном поиске решений, направленных на улучшение экологических стандартов качества. Эта цель была достигнута благодаря использованию на каждом этапе производственного процесса ценных материалов, пригодных для вторичной переработки, отсутствию токсичных для человека и вредных для окружающей среды веществ, а также благодаря внедрению передовых технологий и оборудования, работающего на чистой энергии от фотоэлектрических систем, установленных на крыше штаб-квартиры компании в г. Джуссано. Компания использует такие материалы, как алюминий, стекло, дерево – полностью перерабатываемые и уже частично переработанные материалы, краски Ecoloursystem, не содержащие растворителей, а также экологически упаковку. Свидетельство консолидированной экологичности и непрерывной последовательности, исследовательской деятельности и взгляда, всегда устремленного в будущее, что выражается в технологических инновациях систем, дверей и мебели, произведенных с осознанием того, что человеку стоит поручать только деятельность с высокой добавленной стоимостью.

汉语 始终至终追求全方位的卓越品质。Rimadesio 肩负使命，不断探索精进生态质量标准的解决方案。品牌目标之达成有赖于珍贵的可回收材料，该材料在所有制造阶段皆不会产生危害人体和环境之有毒物质，同时结合业界前沿的技术以及先进机械装置；而位于朱塞诺 (Giussano) 品牌总部建筑屋顶上的光伏发电设备为上述之机械装置供给干净的能源。除了可完全回收和已部分回收的铝材、玻璃、木材等材料之外，还有环保色彩系统 (Ecoloursystem) 的无溶剂涂料和生态环保型包装。深植的绿色 DNA、跨领域的协同性、持续的研究工作以及具前瞻性的未来展望皆体现在家具系统、各式门类 and 家具配件的技术创新上，其本着信赖人类才能胜任高附加价值活动的意念研发而成。

ECOLORSYSTEM LACQUERED GLASS

GLOSSY MATT		GLOSSY MATT		GLOSSY MATT		GLOSSY MATT		GLOSSY MATT		GLOSSY MATT			
305	138 cipria	45	97 avorio	59	105 grigio chiaro	40	115 grigio cenere	53	95 bianco neve	50	108 bianco latte		
51	113 nocciola	52	107 corda	56	98 lino	312	145 grigio seta	47	96 grigio perla	78	114 sabbia		
306	139 terracotta	85	130 tufo	310	143 creta	38	121 azzurro cera	36	117 blu Londra	74	110 canapa		
76	116 rosso india	308	141 pepe	317	600 grigio artico	35	100 blu notte	39	122 verde inglese	73	109 giallo kashmir		
75	129 amaranto	309	142 sandalo	88	132 grigio scuro	86	131 blu oceano	314	147 verde lichene	43	119 laguna		
307	140 java	58	99 caffè	311	144 grigio lava	313	146 blu scuro	315	148 verde scuro	33	111 verde oliva		
		84	128 moro	46	102 nero					316	149 verde terra		

ECOLORSYSTEM METALIZED GLASS

GLOSSY MATT		SAHARA		TAIGA		DIAMANTE	
304	137 platino	504	platino sahara	804	platino taiga	404	platino diamante
69	126 palladio	569	palladio sahara	869	palladio taiga	469	palladio diamante
83	127 piombo	583	piombo sahara	883	piombo taiga	483	piombo diamante
301	134 peltro	501	peltro sahara	801	peltro taiga	401	peltro diamante
302	135 grafite	502	grafite sahara	802	grafite taiga	402	grafite diamante
303	136 bronzo	503	bronzo sahara	803	bronzo taiga	403	bronzo diamante
300	133 rame	500	rame sahara	800	rame taiga	400	rame diamante

ECOLORSYSTEM SAHARA GLASS

551	nocciola sahara	552	corda sahara	517	lino sahara	512	grigio seta sahara	514	verde lichene sahara	574	canapa sahara
506	terracotta sahara	508	pepe sahara	524	grigio artico sahara	522	blu oceano sahara	515	verde scuro sahara	543	laguna sahara
507	amaranto sahara	509	sandalo sahara	521	grigio scuro sahara	513	blu scuro sahara			523	verde oliva sahara
540	java sahara	519	caffè sahara	511	grigio lava sahara						
		584	moro sahara	546	nero sahara						

ECOLORSYSTEM TAIGA GLASS

851	nocciola taiga	852	corda taiga	817	lino taiga	812	grigio seta taiga	814	verde lichene taiga	874	canapa taiga
806	terracotta taiga	808	pepe taiga	824	grigio artico taiga	822	blu oceano taiga	815	verde scuro taiga	843	laguna taiga
807	amaranto taiga	809	sandalo taiga	821	grigio scuro taiga	813	blu scuro taiga			823	verde oliva taiga
840	java taiga	819	caffè taiga	811	grigio lava taiga						
		884	moro taiga	846	nero taiga						

NEUTRAL GLASS

55	specchio
68	specchio grigio

TRANSPARENT GLASS

890	trasparente taiga
590	trasparente sahara
490	trasparente diamante
05	trasparente extrachiaro
00	trasparente
63	grigio trasparente
65	bronzo trasparente
390	verde trasparente
391	blu trasparente

SATINATED GLASS

67	riflettente chiaro
64	riflettente grigio
81	riflettente bronzo
891	acidato taiga
591	acidato sahara
02	acidato extrachiaro
01	acidato
03	acidato grigio
04	acidato bronzo
82	nuvola extrachiaro
80	nuvola

MESH GLASS

60	rete alluminio
61	rete inox
62	rete bronzo
66	maglia gold
87	maglia rame
06	fibra argento
08	fibra bronzo







REFLEX GLASS

90	bianco reflex
92	kaki reflex
94	cacao reflex
89	nero reflex





ECOLORSYSTEM MATT LACQUERED

					
305 cipria	45 avorio	59 grigio chiaro	40 grigio cenere	53 bianco neve	16 bianco latte
					
51 nocciola	52 corda	56 lino	312 grigio seta	47 grigio perla	78 sabbia
					
306 terracotta	85 tufo	310 creta	38 azzurro cera	36 blu Londra	74 canapa
					
76 rosso india	308 pepe	317 grigio artico	35 blu notte	39 verde inglese	73 giallo kashmir
					
75 amaranto	309 sandalo	88 grigio scuro	86 blu oceano	314 verde lichene	43 laguna
					
307 java	58 caffè	311 grigio lava	313 blu scuro	315 verde scuro	33 verde oliva
					
	84 moro	13 nero			316 verde terra

ECOLORSYSTEM LACQUERED METALIZED

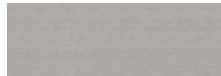
	
304 platino	302 grafite
	
69 palladio	303 bronzo
	
83 piombo	300 rame
	
301 petro	

ALUMINIUM

31 alluminio lucido

30 alluminio

14 brown

318 nickel grigio

22 nero lucido

LEATHER

C23 bianco ghiaccio

C17 sand

C29 toupè

C22 caramello

C28 fango

C11 moka

SYNTHETIC LEATHER

157 arena

158 agata

155 nube

154 argilla

160 miele

153 castoro

159 etna

156 rubens

LUX FABRIC

T006 gesso

T052 segale

T044 acciaio

T012 marmotta

T042 ruggine

T051 salvia

MATERIAL FABRIC

T020 nebbia

T019 papiro

T009 piuma











T017 roccia

T001 terracotta



T003 brandy

T018 tabacco

TECH FABRIC

TT01 duna

TT03 tortora

TT05 mosto

TT07 antracite

TT09 fumo

TT10 ghiaccio

TT11 giada

TT19 canyon

TT20 dolomiti

TT21 cedro

LITECH

G001 crema

G002 moka

G003 pietra

G004 grigio rigato

MARBLE

28 calacatta

184 crystal grey

186 crystal brown

180 emperador



183 noir saint laurent

187 verde lepanto

182 rosso lepanto

181 nero marquinia

MATT MARBLE

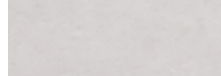
198 calacatta opaco

194 crystal grey opaco

191 nero marquinia opaco

185 crystal white opaco

WOOD

711 rovere

15 noce

19 rovere termotrattato

27 rovere nero

710 tinto ebano

SAHARA WOOD

17 noce sahara





20 rovere termotrattato sahara

TAIGA WOOD

701 rovere taiga

700 tinto ebano taiga

MELAMINE

07 melaminico olmo

09 melaminico rovere

25 melaminico larice car
INTERNAL MELAMINE

UB07 mel. cuoio grigio

UB09 mel. cuoio brown

Collection designed by Giuseppe Bavuso.

GRÜN BECK

RIMADESIO - WIEN . AT

interior architects | design brand stores

Margaretenstraße 93 | A-1050 Wien
<https://rimadesio-wien.at>
+43 1 306 35 41
rimadesio@gruenbeck.co.at

RIMADESIO SPA
Via Furlanelli 96
20833 Giussano (MB) Italy
T +39 0362 3171
rimadesio@rimadesio.it

MILANO FLAGSHIP STORE
Via Visconti di Modrone 26
20122 Milano Italy
T +39 02 76280708
milano@rimadesio.it

LONDON FLAGSHIP STORE
83-85, Wigmore street
1WU 1DL London
T +44 2074 862193
london@rimadesio.co.uk

NEW YORK FLAGSHIP STORE
102 Madison Ave
New York, NY 10016
T +1 917 388 2650
usa@rimadesio.us

www.rimadesio.it



Follow us on Instagram, Facebook, LinkedIn,
WeChat, Weibo, Little Red Book.

Art direction and graphic project: Juma
Photo: Federico Cedrone, Santi Caleca
Technical photo: F2 Fotografia
Styling: Studiopepe; Patrizia Cantarella with Rossella Ballabio;
Martina Lucatelli with Martina Dalla Bona;
Simona Silenzi Studio; Gaia Marchesini and Giordano Sarno.

Thanks to: Amini Carpets, Azucena, B&B Italia, Beyond Object, Borsalino, Brera Props, Carl Hansen & Søn, Dedar Milano, Egidio Milesi, Emil, Etel, Fabbrica Pelletterie Milano, Fantini, Flos, Gröpk ceramics, Gruppo Meregalli, Henry Timi, Ivano Redealli, Kn Industrie, Lanerossi, Living Divani, Lorenzi Milano, Lorenzo Franceschinis, Lumina, Maru Gallery, Matteo Thun Atelier, Manus Factor, Monteverro, Montillo 1980, Nemo, Noorstad, Noorth, Nude, Officine Saffi, Officine Saffi, Pineider 1774, Pinetti, Rains, Raumgestalt, Santa&Cole, Scandola Marmi, Society Limonta, Tenoha Milano, Trecinquesei, Unurgent Argilla, Up to you Anthology, Vitra, Vluv/Intentions, When Objects Work.

Films and print: Optima
Printed in Italy, 2024

AWARDS

1993	Siparium	Young & Design
2000	Zenit	Award KBB
2001	Zenit	selection Design Index ADI
2002	Siparium	Top100 Frames
2005	Graphis	selection Design Index ADI
2007	Vela	selection Design Index ADI
2008	Vela	mention XXI Premio Compasso d'Oro ADI
2015	Wind	winner Red Dot Award
2016	Cover	Best Furniture System AZ Award
2016	Alambra	selection Design Index ADI
2017	Sail	selection Design Index ADI
2017	Soho	Architectural products AZ awards
2017	Daimon	Interior Design Magazine Best of Year awards
2020	Modulor	People's Choice winner AZ Awards
2020	Modulor	Architectural Products Award of Merit AZ Awards
2020	Modulor	selection Design Index ADI
2021	Francis	selection Design Index ADI
2021	Modulor	LivingEtc Style Awards
2022	Maxi	selection Design Index ADI
2022	Aliante	finalist Interior's best of the Year awards
2022	Aliante	finalist A+Product awards
2023	Maxi	winner German Design Awards
2023	Radius	Architect's Newspaper's Best of Products Awards

PATENTED:

Radius, Aliante, Rialto, Maxi, Sail, Soho, Velaria, Stripe, Daimon, Graphis, Zen, Zen frame, Siparium, Moon, Vela, Luxor, Even, Aura, Spin, Link+, Planet, Flat, Alambra, Abacus living, Self, Cover, Zenit, Dress bold, Abacus.

REGISTERED TRADEMARKS:

Rimadesio, Colorsystem, Litech, Siparium, Velaria, Abacus.

