

# WALK-IN CLOSETS

5 WALK-IN CLOSETS  
6 ZENIT, 46 DRESS BOLD, 70 ABACUS

[rimadesio-wien.at](http://rimadesio-wien.at)

IT La cabina armadio contemporanea: una tipologia d'arredo particolare, in cui le esigenze compositive si sommano all'importanza del dettaglio e delle soluzioni per l'organizzazione dello spazio. Un tema da sempre al centro del progetto di Rimadesio, per la ricerca di una sintesi ancora più esclusiva fra architettura e sistemi componibili. Il risultato è una collezione composta da tre sistemi, differenti nella logica progettuale, ma accomunati da un'eccezionale versatilità, per garantire la massima possibilità di personalizzazione funzionale ed estetica.

DE Der moderne begehbare Kleiderschrank: ein besonderer Möbeltyp, bei dem sich die kompositorischen Anforderungen mit der Aufmerksamkeit für Details und Lösungen zur Raumorganisation verbinden. Ein Thema, das seit jeher im Fokus des Designs von Rimadesio steht, denn es geht um die Suche nach einer möglichst exklusiven Synthese zwischen Architektur und modularen Systemen. Das Ergebnis ist eine Kollektion aus drei Systemen, die sich in ihrer gestalterischen Logik unterscheiden, die aber durch ihre außergewöhnliche Vielseitigkeit miteinander verbunden sind, um ein Maximum an funktionalen und ästhetischen Anpassungsmöglichkeiten zu gewährleisten.

FR Le dressing contemporain: un type particulier d'ameublement, dans lequel les exigences de composition se superposent à l'importance des détails et des solutions pour organiser l'espace. Un thème qui a toujours été au centre du projet de Rimadesio, dans la recherche d'une synthèse encore plus exclusive entre architecture et systèmes modulaires. Le résultat est une collection composée de trois systèmes ayant des logiques de conception différentes, mais unis par une polyvalence exceptionnelle, pour garantir une possibilité maximale de personnalisation fonctionnelle et esthétique.

ES El vestidor contemporáneo: un tipo de mobiliario particular, en el que las necesidades compositivas añaden importancia al detalle y a las soluciones para organizar el espacio. Un tema que siempre ha estado en el centro del proyecto de Rimadesio, en la búsqueda de una síntesis aún más exclusiva entre arquitectura y sistemas modulares. El resultado es una colección compuesta por tres sistemas, diferentes en cuanto a su lógica de diseño, pero todos ellos unidos por su excepcional versatilidad, para garantizar la máxima posibilidad de personalización funcional y estética.

RU Современная гардеробная – особый тип мебели, в котором композиционные требования повышают важность деталей и решений по организации пространства. В поисках еще более эксклюзивного синтеза между архитектурой и модульными системами эта тема всегда занимала центральное место в проектах Rimadesio. Результатом стала коллекция, состоящая из трех систем, отличающихся логикой дизайна, но объединенных исключительной универсальностью, гарантирующей максимальную возможность функциональной и эстетической индивидуализации.

汉语 当代的步入式衣柜为一种特殊的家具类型，其组合性需求更加重视细节和空间组织性的解决方案。该主题始终为 Rimadesio 的设计核心，致力追寻建筑与模块化系统之间独特的融合。我们的研究成果为一个以三套设计系统构成系列，尽管它们的设计逻辑各不相同，但皆兼备丰富的多样性，确保功能与美感在客制化方面的最大可能性。

THE CONTEMPORARY WALK-IN CLOSET: A PARTICULAR TYPE OF FURNITURE, WHERE COMPOSITIONAL REQUIREMENTS COMBINE WITH THE IMPORTANCE OF THE DETAIL AND SOLUTIONS FOR THE ORGANIZATION OF SPACE. A THEME WHICH HAS ALWAYS BEEN THE FOCUS OF THE RIMADESIO DESIGN, IN THE SEARCH FOR AN EVER MORE EXCLUSIVE SYNTHESIS BETWEEN ARCHITECTURE AND MODULAR SYSTEMS. THE RESULT IS A COLLECTION THAT INCLUDES THREE SYSTEMS, DIFFERENT IN DESIGN LOGIC, BUT UNITED BY EXCEPTIONAL VERSATILITY, TO ENSURE MAXIMUM POTENTIAL OF FUNCTIONAL AND AESTHETIC CUSTOMIZATION.



THE WALK-IN CLOSET THAT'S ALL ABOUT LIGHTNESS AND VERSATILITY OF COMPOSITION. THE MADE-TO-MEASURE FLOOR-TO-CEILING UPRIGHTS ENABLE FREE ARRANGEMENT OF THE EQUIPMENT, BOTH IN TERMS OF NUMBER AND HEIGHT REQUIRED. THE AVAILABLE FINISHINGS INVITE TWO POSSIBLE AESTHETIC INTERPRETATIONS.

IT La cabina armadio all'insegna della leggerezza e della versatilità compositiva. I montanti, sempre su misura da terra a soffitto, permettono una libera disposizione delle attrezzature, nel numero e all'altezza desiderata. Le finiture previste invitano a due possibili interpretazioni estetiche.

DE Der begehbare Kleiderschrank im Zeichen von Leichtigkeit und Gestaltungsvielfalt. Die raumhohen Stützen nach Maß erlauben eine freie Anordnung der Ausstattung, in der gewünschten Anzahl und in der gewünschten Höhe. Die angebotenen Oberflächen regen zu zwei unterschiedlichen ästhetischen Interpretationen an.

FR Le dressing sous le signe de la légèreté et d'une composition polyvalente. Les montants sont toujours réalisés sur mesure du sol au plafond et permettent une disposition libre des équipements, en nombre et à la hauteur souhaitée. Les finitions prévues invitent à deux interprétations esthétiques possibles.

ES El vestidor ofrece ligereza y versatilidad compositiva. Los montantes, siempre hechos a medida desde el suelo hasta el techo, permiten disponer libremente todos los accesorios, usando el número necesario a la altura deseada. Los acabados disponibles invitan a dos posibles interpretaciones estéticas.

RU Гардеробная, характеризующаяся легкостью и композиционной универсальностью. Стойки от пола до потолка позволяют свободно размещать оснащение в нужном количестве и на нужной высоте. Предусмотренные варианты отделки предполагают две возможные эстетические интерпретации.

汉语 步入式衣橱的核心在于轻盈感和组合多样性。立柱皆由地面至天花板按尺寸定制，可根据所需的配件数量和高度自由配置。多样的表面处理可演绎出两种设计美学。

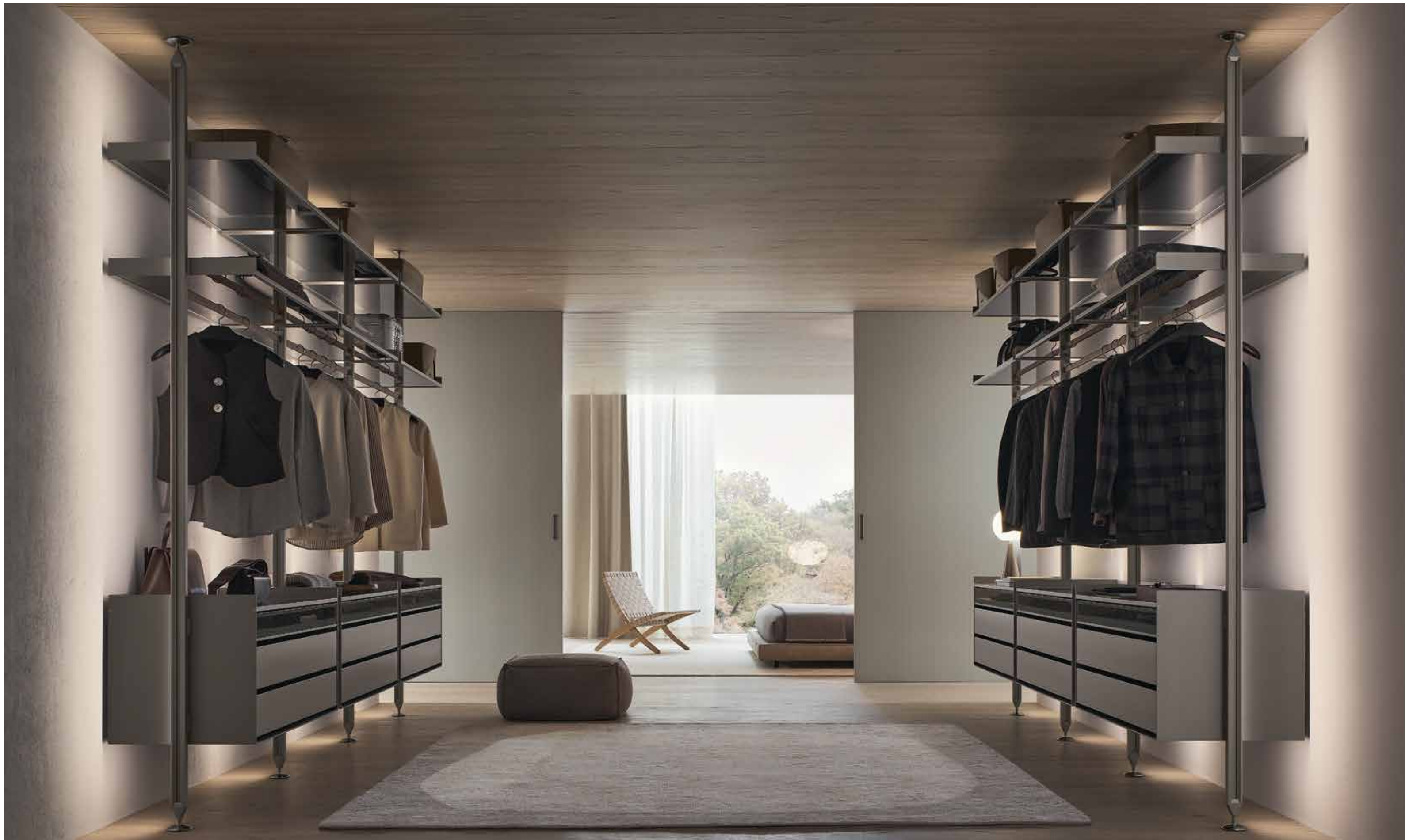

Structure and aluminium fronts: 304 platino  
Drawer unit top and glass front: 67 riflettente chiaro  
Lux fabric internal lining: T052 segale  
Glass shelves: 63 grigio trasparente

In this photo  
Sliding doors: Graphis plus

EN The Zenit walk-in closet expands its design potential with the introduction of an exclusive range of modular drawer units, made with the latest production technologies for processing extruded and sheet aluminium. The aluminium drawers are just 8 mm thick and internally lined with fabric or synthetic leather. Available in three widths, three heights and four aesthetic formats to meet highly personal demands concerning the organisation of walk-in closets: open drawers without fronts, drawers with glass fronts, drawers with lacquered fronts and drawers with synthetic leather fronts.

IT La cabina armadio Zenit amplia le proprie potenzialità progettuali con l'introduzione di un esclusivo programma di cassettiere modulari e componibili, realizzate con le più recenti tecnologie produttive per la lavorazione dell'alluminio estruso e in lastra. I cassetti in alluminio, dallo spessore di soli 8 mm, sono rivestiti internamente in tessuto o similpelle. Disponibili in tre larghezze, tre altezze e in quattro versioni estetiche, rispondono alle esigenze più personali nell'organizzazione della cabina armadio: cassetto aperto senza frontale, cassetto con frontale in vetro, cassetto con frontale in alluminio laccato e cassetto con frontale in similpelle.

DE Der begehbare Kleiderschrank Zenit erweitert seine Gestaltungsmöglichkeiten mit der Einführung eines exklusiven Programms von modularen und kombinierbaren Schubladenelementen, die mit den neuesten Produktionstechnologien zur Verarbeitung von stranggepresstem Aluminium und Aluminiumblech hergestellt werden. Die Schubladen aus Aluminium, mit einer Stärke von nur 8 mm, sind innen mit Stoff oder Kunstleder ausgekleidet. Die in drei Breiten, drei Höhen und vier ästhetischen Versionen erhältlichen Schubladen erfüllen sämtliche individuellen Anforderungen an die Organisation des begehbaren Kleiderschranks: offene Schublade ohne Frontblende, Schublade mit Glasfrontblende, Schublade mit lackierter Aluminiumfrontblende und Schublade mit Kunstlederfrontblende.

FR Le dressing Zenit élargit son potentiel de conception avec l'introduction d'un programme exclusif de commodes modulaires et modulables, réalisées avec les dernières technologies de production pour l'usinage de l'aluminium extrudé et en feuilles. Les tiroirs en aluminium, d'une épaisseur de 8 mm seulement, sont revêtus intérieurement de tissu ou de similicuir. Disponibles en trois largeurs, trois hauteurs et quatre versions esthétiques, ils répondent aux exigences de chacun pour l'organisation du dressing: tiroir ouvert sans façade, tiroir avec façade en verre, tiroir avec façade en aluminium laqué et tiroir avec façade en similicuir.

ES El vestidor Zenit amplía su potencial de diseño con la introducción de un programa exclusivo de cajoneras modulares y componibles, fabricados con las últimas tecnologías de producción del aluminio extruido y en placas. Los cajones de aluminio, de solo 8 mm de espesor, incorporan un revestimiento interior de tela o polipiel. Disponibles en tres anchuras, tres alturas y cuatro versiones estéticas que responden a las necesidades más personales relativas a la organización del vestidor: cajón abierto sin frontal, cajón con frontal de cristal, cajón con frontal de aluminio lacado y cajón con frontal de polipiel.

RU Потенциал гардеробной Zenit расширяется благодаря внедрению эксклюзивной линейки модульных и секционных комодов, изготовленных по новейшим технологиям обработки экструдированного и листового алюминия. Алюминиевые ящики толщиной всего 8 мм внутри обиты тканью или синтетической кожей. Они представлены в трех вариантах ширины, трех вариантах высоты и четырех вариантах отделки, что позволяет удовлетворить самые взыскательные требования к организации гардеробной: открытые ящики без фасада, ящики со стеклянным фасадом, ящики с фасадом из лакированного алюминия и ящики с фасадом из синтетической кожи.

汉语 通过引进一项独家的组合式模块抽屉柜方案，搭配挤压铝材和铝板工艺的最新生产技术，Zenit 步入式衣橱得以拓展设计潜力。抽屉以铝合金打造，厚度仅 8 毫米，以布面或仿真皮革包覆。这款步入式衣橱针对空间组织性的个人化需求在尺寸方面给出三种宽度和三种高度，并提供四种美学风格的抽屉版本：无抽面、带有玻璃抽面、烤漆抽面或以仿真皮革包覆的抽面。

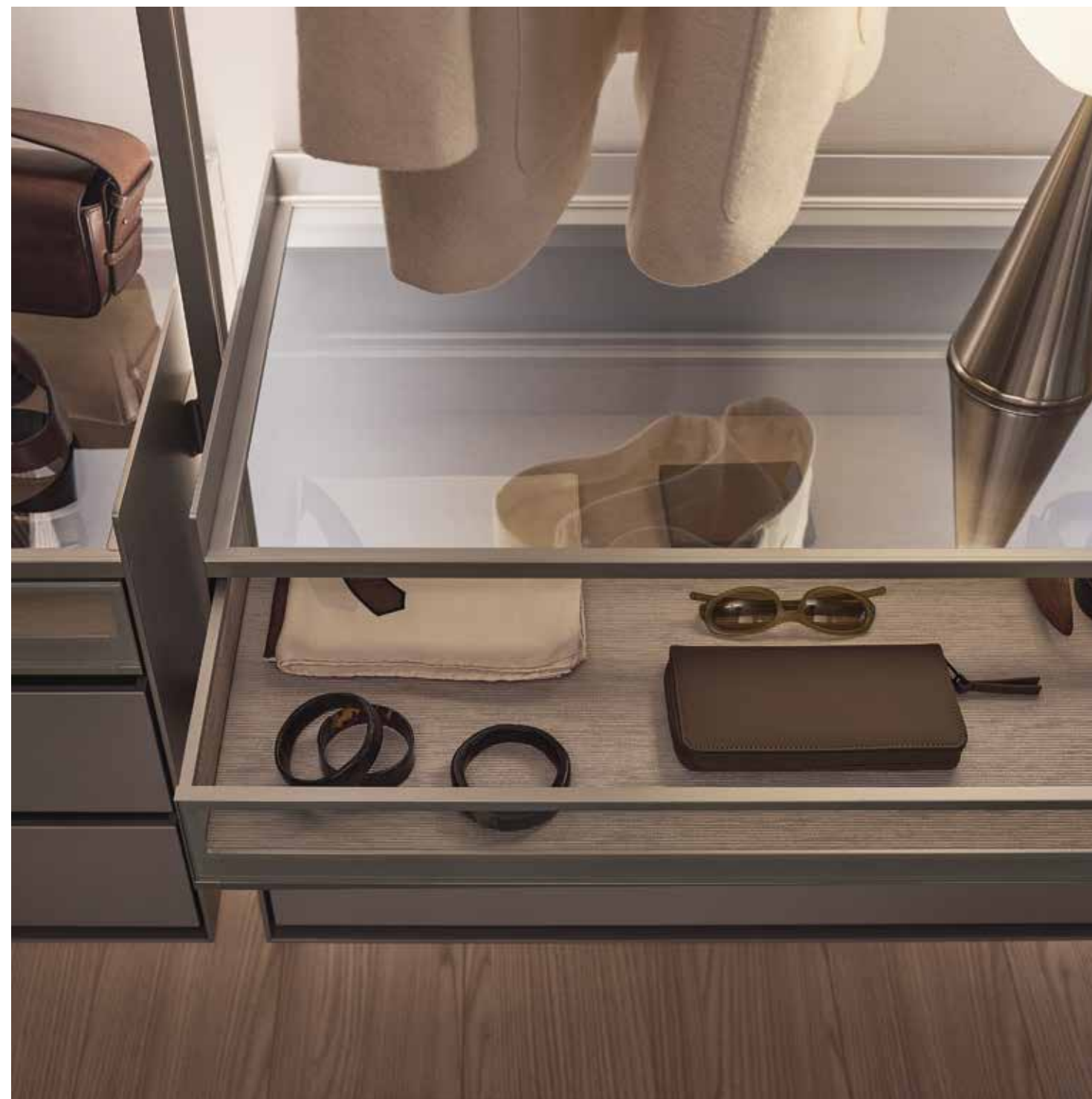

Structure and aluminium fronts: 304 platino  
Drawer unit top and glass front: 67 riflettente chiaro  
Lux fabric internal lining: T052 segale  
Glass shelves: 63 grigio trasparente



Structure: 304 platino  
Glass shelves: 63 grigio trasparente  
Shelves, drawer unit top, front and drawer internal lining  
in synthetic leather: 154 argilla





EN The Zenit modular shelves, bars and drawers can be covered in synthetic leather available in 8 exclusive Rimadesio colours. The organisation of the space is resolved with a series of components and solutions that combine essential design, maximum practicality and attention to detail.

IT I ripiani, le aste e le cassettiere modulari di Zenit possono essere rivestiti in similpelle, disponibile in 8 colori esclusivi Rimadesio. L'organizzazione dello spazio è risolta con una serie di componenti e soluzioni che associano essenzialità del design, massima praticità e ricercatezza.

DE Die Einlegeböden, Stäbe und modularen Kommoden von Zenit können mit Kunstleder bezogen werden, das in 8 exklusiven Rimadesio-Farben erhältlich ist. Die Organisation des Raums wird mit einer Reihe von Komponenten und Lösungen umgesetzt, die essenzielles Design, maximale Zweckmäßigkeit und Raffinesse vereinen.

FR Les étagères, tringles et commodes modulaires de Zenit peuvent être recouvertes de similicuir, 8 coloris exclusifs Rimadesio sont disponibles. L'espace s'organise avec une série d'éléments et de solutions qui allient design essentiel, praticité maximale et raffinement.

ES Los estantes, barras y cajoneras modulares de Zenit se pueden revestir en polipiel, disponible en ocho colores exclusivos de Rimadesio. La organización del espacio se resuelve con una serie de componentes y soluciones que combinan diseño esencial, máxima practicidad y refinamiento.

RU Полки, штанги и модульные комоды Zenit могут быть обиты синтетической кожей, представленной в 8 уникальных цветах Rimadesio. Организация пространства осуществляется с помощью ряда компонентов и решений, сочетающих в себе лаконичный дизайн, максимальную практичность и изысканность.

汉语 Zenit 的模块化层板、导轨和抽屉柜皆以 8 种 Rimadesio 的独家仿真皮革包覆。有赖于一系列涉及设计本质、最大实用性和精致品味的组合件和解决方案，空间组织性得以实现。







Structure: 303 bronzo  
Glass shelves: 61 rete inox  
Shelves, accessories and clothes-hanger bar  
in synthetic leather: 154 argilla

In this photo  
Storage system: Cover



EN The aluminium upright and the exclusive fixing system guarantee maximum structural solidity to the Zenit compositions. The bracket with expansion fixing enables each individual element to be leveled. The uprights can be fitted to the ceiling and on the wall to allow the system to be used in any space.

IT Il montante in alluminio e l'esclusivo sistema di aggancio garantiscono la massima solidità strutturale alle composizioni Zenit. Il supporto con fissaggio ad espansione consente di posizionare in bolla ogni singolo elemento. I montanti sono disponibili a soffitto e a parete per consentire la collocazione del sistema in ogni ambiente.

DE Der Aluminiumständer und das einzigartige Kupplungssystem garantieren eine maximale strukturelle Stabilität der Zenit-Kompositionen. Die Halterung mit Spreizfixierung ermöglicht es, jedes Element waagrecht zu positionieren. Die Ständer sind sowohl für Decken- als auch für Wandmontage erhältlich, damit das System in jeder Umgebung aufgestellt werden kann.

FR Le montant en aluminium et le système exclusif d'accrochage garantissent une solidité structurelle maximale aux compositions Zenit. Le support avec fixation à expansion permet un positionnement parfaitement horizontal de chaque élément. Les montants au plafond et au mur permettent l'installation du système dans n'importe quel environnement.

ES El montante de aluminio y el exclusivo sistema de acoplamiento garantizan la máxima solidez estructural en las composiciones Zenit. El soporte con fijación de expansión permite colocar cada elemento a nivel. Los montantes están disponibles para montaje en el techo y en la pared, de manera que el sistema se puede utilizar en cualquier ambiente.

RU Алюминиевые стойки и уникальная система креплений гарантируют максимальную прочность конструкции композиций Zenit. Кронштейн с бесшаговым креплением позволяет максимально ровно выставить каждый элемент по горизонтали. Монтаж стоек можно осуществлять к стенам или к потолку, благодаря чему систему можно установить в любом помещении.

汉语 铝制立柱和独特的连接系统确保Zenit组合具有最大的结构稳固性。带有膨胀固定装置的支架使每个单独元件能够平稳安装。该系统的立柱有天花板式和墙面式可供选择，两者在任何环境中皆可安装。



Structure: 303 bronzo  
Glass shelves: 61 rete inox  
Accessories in synthetic leather: 154 argilla



EN Rimadesio has always paid particular attention to the search for new colours and material surfaces. This attitude is also reflected in solutions that are always coordinated on the inside and outside of the cabinets, including the finishings of the metal and synthetic leather components, the wood and the lacquering of glass.

IT Rimadesio presta da sempre un'attenzione particolare alla ricerca di nuove cromie e superfici materiche. Quest'attitudine si riflette anche nella garanzia di soluzioni sempre coordinate tra interno ed esterno dei contenitori, tra le finiture dei componenti metallici e in similpelle, le essenze e le laccature dei vetri.

DE Rimadesio legt seit jeher ein besonderes Augenmerk auf die Suche nach neuen Farben und Materialoberflächen. Dieses Bestreben spiegelt sich auch in der Bereitstellung von Lösungen wider, die stets zwischen dem Inneren und dem Äußeren der Behälter, zwischen den Oberflächen der Metall- und Kunstlederkomponenten, den Hölzern und der Lackierung des Glases abgestimmt sind.

FR Rimadesio a toujours accordé une attention particulière à la recherche de nouvelles couleurs et de nouveaux matériaux de finition. Cette attitude transparait également dans la garantie de solutions toujours coordonnées entre l'intérieur et l'extérieur des rangements, entre les finitions des éléments en métal et en similicuir, les essences et les laquages des surfaces en verre.

ES Rimadesio siempre ha prestado especial atención a la búsqueda de nuevos colores y superficies materiales. Esta actitud también se refleja en la garantía de soluciones siempre coordinadas entre el interior y el exterior de los contenedores, entre los acabados de los componentes metálicos y de polipiel, las maderas y el lacado del vidrio.

RU Компания Rimadesio всегда уделяла особое внимание поиску новых оттенков и материалов поверхностей. Это отношение также отражается в предоставлении решений, согласующихся с внутренним и внешним видом систем хранения, и сочетающихся отделкой металла и синтетической кожи, дерева и лакировкой стекла.

汉语 Rimadesio 在找寻新色彩和表面材质方面的研究始终不遗余力。这份底蕴也体现在确保柜体内部和外部协调的解决方案上的坚持不懈，包括金属和人造皮革部件的饰面、各种不同类型的木材和玻璃烤漆。



EN An architectural value for the walk-in closet: with the monochrome black offer, the Zenit system becomes a stylistic element of great room characterization. The elements of the system can be freely positioned, in the number and at the height required.

IT Un valore architettonico per la cabina armadio: con la proposta monocoloro nero, il sistema Zenit diventa un elemento stilistico di grande caratterizzazione degli ambienti. Gli elementi del sistema sono liberamente posizionabili, nel numero desiderato e all'altezza desiderata.

DE Ein begehrter Kleiderschrank von architektonischem Wert: Mit der einfarbig schwarzen Ausführung wird das Zenit-System zu einem Stilelement von großer Raumwirkung. Die Systemelemente sind sowohl in der gewünschten Anzahl als auch in der gewünschten Höhe frei positionierbar.

FR Une valeur architecturale pour le dressing: avec le modèle noir, le système Zenit devient un élément stylistique qui donne beaucoup de caractère aux pièces. Les éléments du système peuvent être positionnés librement, en nombre et à la hauteur souhaitée.

ES Un valor arquitectónico para el vestidor: con la propuesta monocolor en negro, el sistema Zenit se convierte en un elemento estilístico que aporta un gran carácter a los ambientes. Los elementos del sistema se pueden colocar libremente, usando el número necesario a la altura deseada.

RU Архитектурная ценность гардеробной: монохромный черный цвет системы Zenit – стилистическое решение, придающее помещению особый характер. Элементы системы размещаются в нужном количестве и на нужной высоте.

汉语 步入式衣柜的建筑价值: Zenit 系统采用单一黑色, 其转化为极具特色的空间风格元素, Zenit 系统的各式布件可以根据需求的数量和高度自由配置。







Structure: 83 piombo  
Glass shelves: 63 grigio trasparente  
Accessories in synthetic leather: 154 argilla  
Drawer units: 09 melaminico rovere grigio



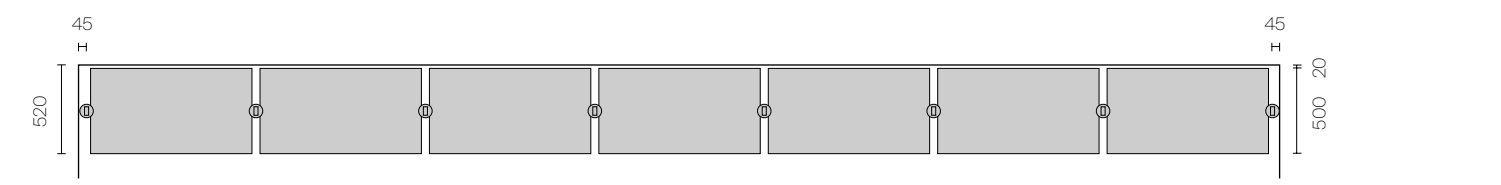
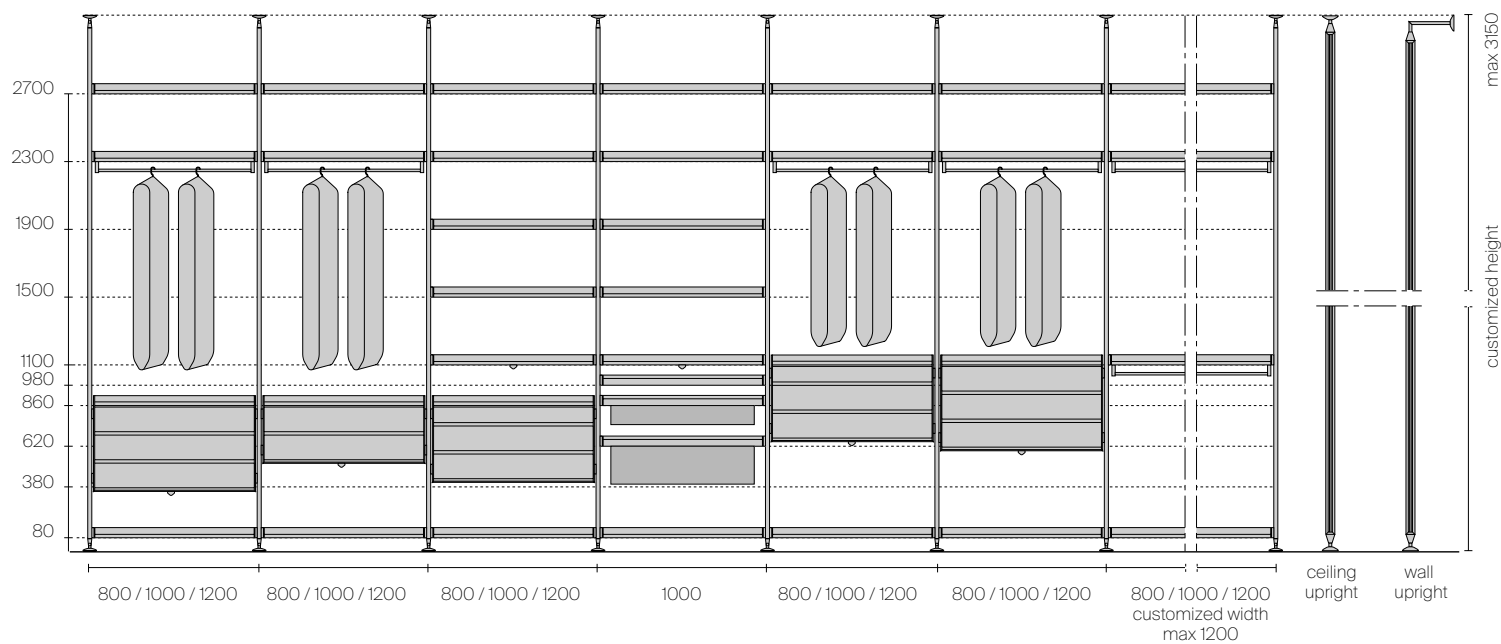
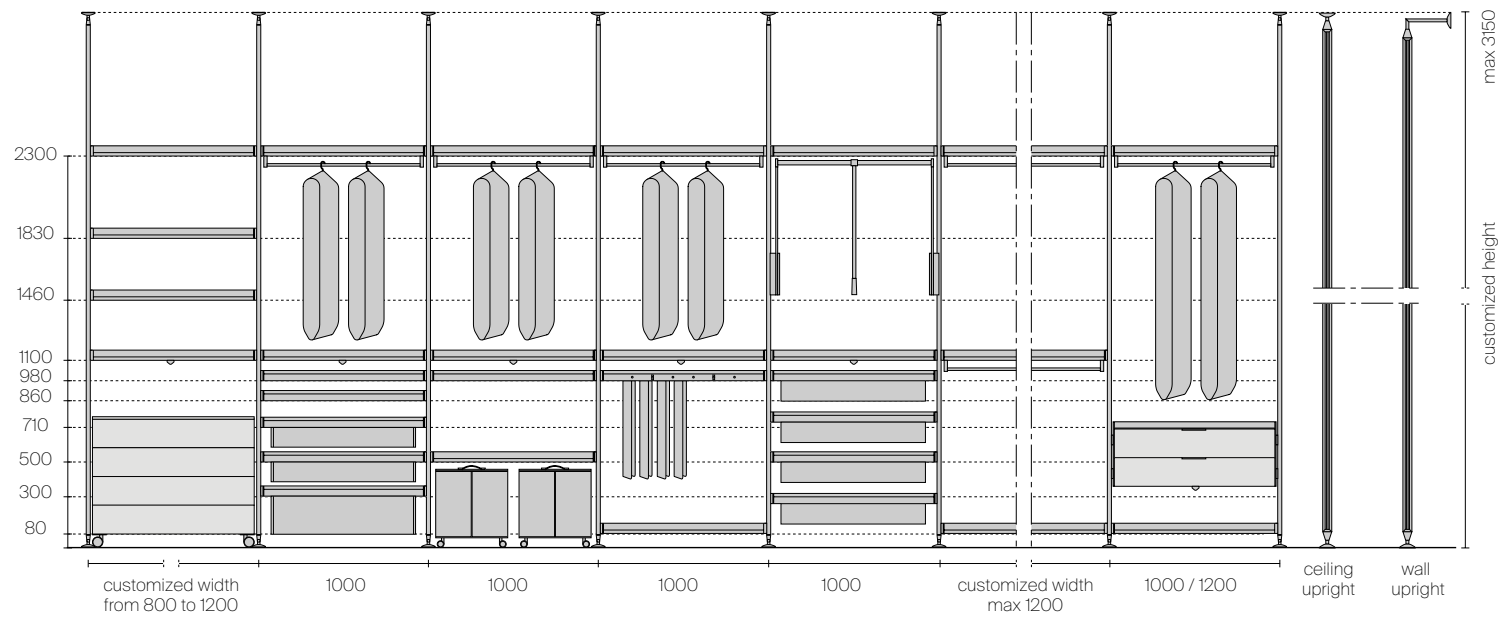

TECHNICAL DESCRIPTION

EN Zenit compositions are always custom-made in height, with wall or ceiling uprights. Shelves and cloth hanger bars are available with three widths, with the possibility to reduce them. All the other elements are available only with the indicated width.

IT Le composizioni Zenit vengono sempre realizzate su misura in altezza, con possibilità di montanti a parete o a soffitto. Le mensole e le barre portabiti sono disponibili in tre larghezze, con inoltre la possibilità di riduzione a misura. Tutti gli altri componenti sono disponibili solo nella larghezza indicata.

DE Zenit Anlage sind immer nach Mass in Hoehe, mit Wand oder Decke-Pfosten hergestellt. Fachboeden und Kleiderstange sind mit drei Breiten verfuegbar. Es is auch moeglich sie nach Mass zu kuerzen. Die andere Zubehoeren sind nur mit der angegebenen Breite verfuegbar.

FR Les compositions Zenit sont toujours sur mesure en hauteur, avec les montants à fixation murale ou au plafond. Les étagères et les tiges porte-manteaux sont disponibles en trois largeurs avec la possibilité de les réduire sur mesure. Tous les autres accessoires sont disponibles seulement dans la dimension indiquée.

ES Las composiciones Zenit están siempre realizadas a medida en altura, con posibilidad de montantes a pared o a techo. Los estantes y las barras de colgar están disponibles en tres anchuras, con la posibilidad de reducción a medida. Los otros accesorios están disponibles sólo en la anchura indicada.

RU Композиции Zenit всегда изготавливаются по индивидуальному размеру по высоте, с возможностью настенного или потолочного монтажа стоек. Полки и штанги для одежды представлены в трех вариантах ширины с возможностью уменьшения до нужного размера. Все остальные компоненты доступны только в указанной ширине.

汉语 Zenit 组合件的高度皆按尺寸定制，立柱可安装于墙面或天花板。层板和衣杆有三种长度可供选择，并可根据需要缩短尺寸。其他所有的部件皆只提供指定宽度。

Linear composition

Calculation of the length of the shelf A  
shelf W = minimum opening W - 1000 - 1000 - 90 mm

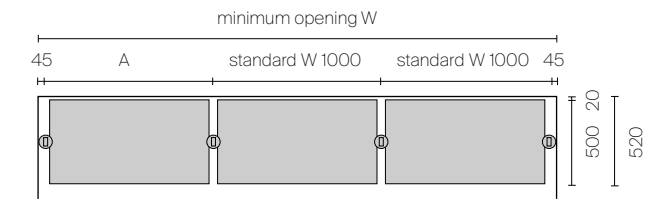

Corner composition with linear shelves

Calculation of the length of the shelf A  
shelf W = minimum opening W - 580 - 1000 mm  
Calculation of the length of the shelf B  
shelf W = minimum opening W - 1000 - 90 mm

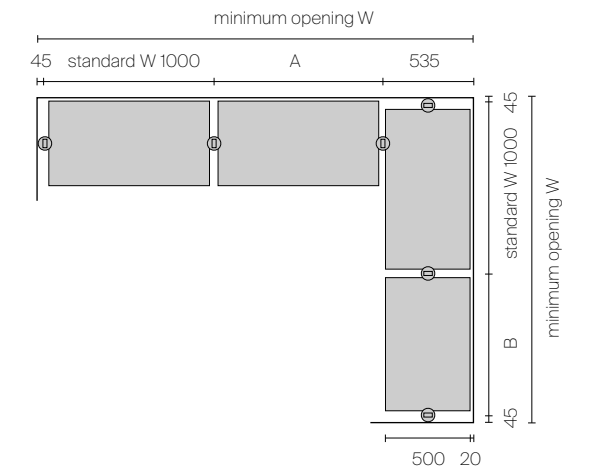

C-shaped composition with linear and corner shelves

Calculation of the length of the shelf A  
shelf W = minimum opening W - 65 - 1165 mm  
Calculation of the length of the shelf B  
shelf W = minimum opening W - 40 - 1165 - 1165 mm

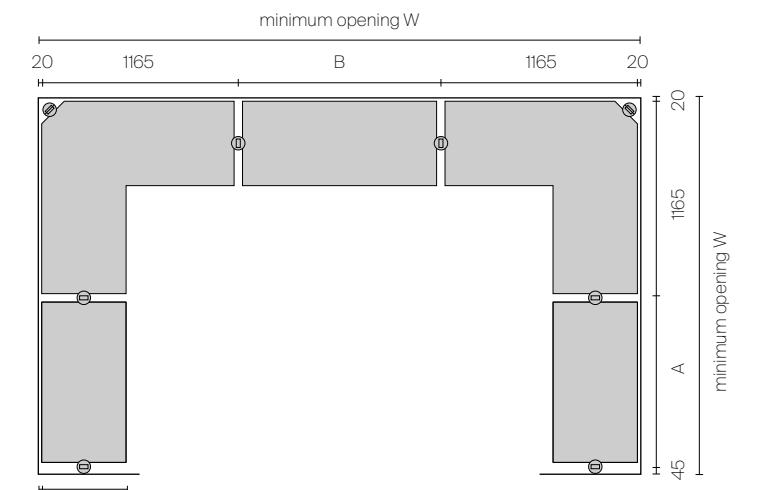



1



2

1. Ceiling upright
2. Wall upright
3. Shelf with perimetrical ring in extruded aluminium
4. Bayonet fixing between the shelf and the die casting support
5. Structural upright in extruded aluminium
6. Support with expansion fixing system which allows to adjust the position of the accessories



3

4

5

6



1



2

1. Pull-out shelf with tie rack
2. Pull-out shelf with organizer tray
3. Pull-out shelf with shoe rack
4. Pull-out shelf with trousers rack and belts tray



3



4

Ceiling

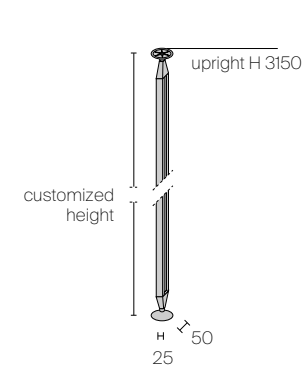

Ceiling backlighted

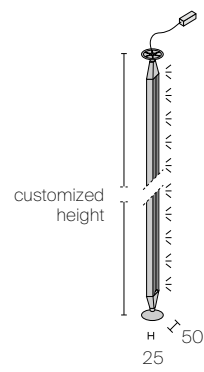

Wall

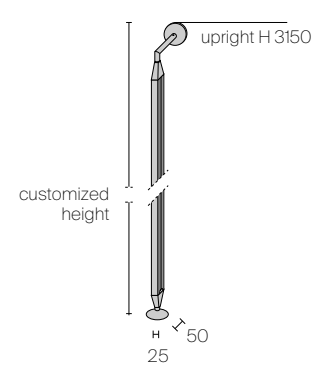

Wall backlighted

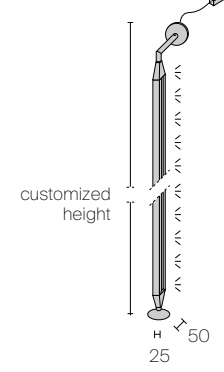

Pull-out small tray in synthetic leather

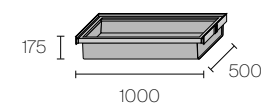

Pull-out big tray in synthetic leather

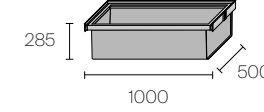

Pull-out shelf with organizer tray in synthetic leather

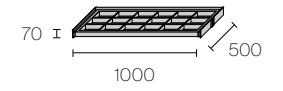

Pull-out shelf with trousers rack and belts tray in synthetic leather

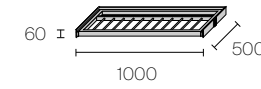

Pull-out shelf with tray rack in synthetic leather

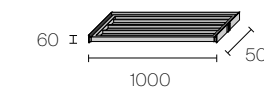

Pull-out shelf with shoe rack in synthetic leather

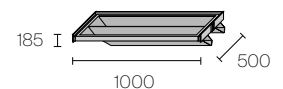



1



2



3



4



5



6



7

1. Suspended drawer unit with 2 aluminium fronts
2. Suspended drawer unit with 1 glass front and 1 aluminium front
3. Suspended drawer unit with 2 synthetic leather fronts
4. Suspended drawer unit with 1 glass front and 1 synthetic leather front
5. Suspended drawer unit with 2 open fronts
6. Suspended drawer unit with 1 glass front and 1 open front
7. Suspended drawer unit with 2 glass fronts

H 400 with two drawers

2 aluminium fronts

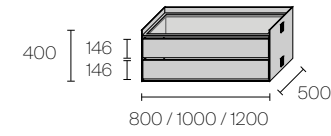

2 glass fronts

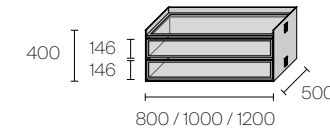

2 synthetic leather fronts

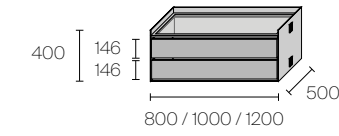

2 open fronts

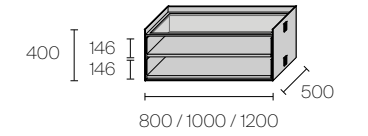

1 glass front, 1 open front

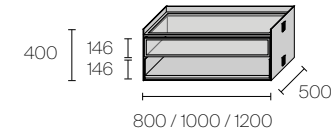

1 glass front, 1 aluminium front

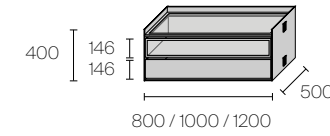

1 glass front, 1 synthetic leather front

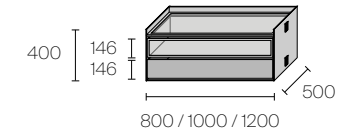

H 515 with three drawers

3 aluminium fronts

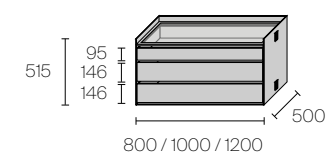

3 glass fronts

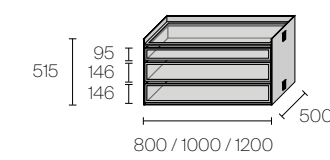

3 synthetic leather fronts

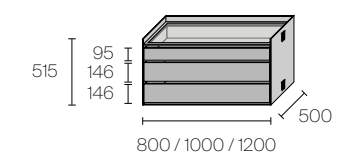

1 glass front, 2 with aluminium fronts

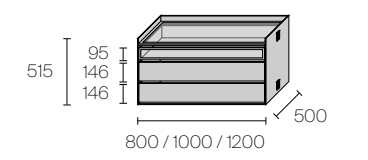

1 glass front, 2 open fronts

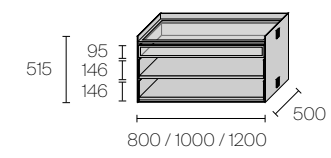

1 glass front, 2 synthetic leather fronts

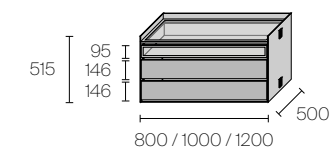

H 566 with three drawers

3 aluminium fronts

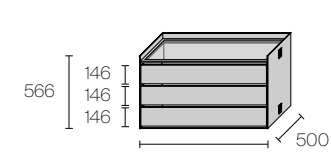

3 glass fronts

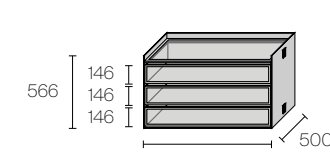

3 synthetic leather fronts

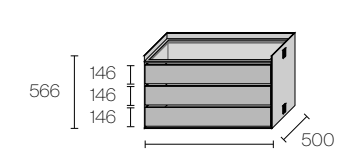

3 open fronts

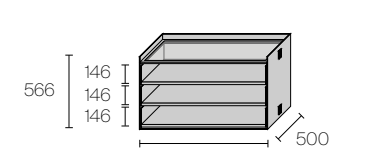

1 glass front, 2 aluminium fronts

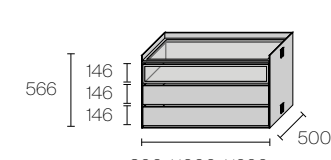

1 glass front, 2 open fronts

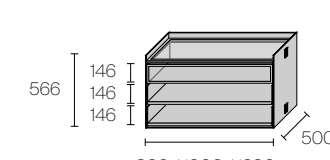

1 glass front, 2 synthetic leather fronts

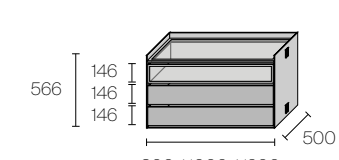

COMPONENTS AND ACCESSORIES

Suspended drawer unit in melamine

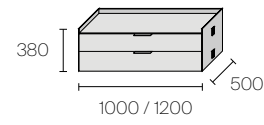

Drawer unit on wheels in melamine with 3 drawers

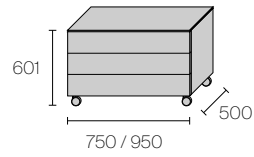

Drawer unit on wheels in melamine with 4 drawers

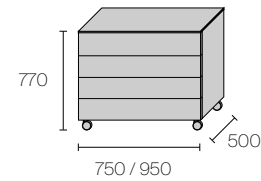

Drawer unit on wheels in lacquered glass with 4 drawers

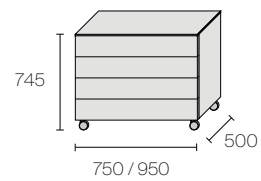

Melamine top with lining in synthetic leather

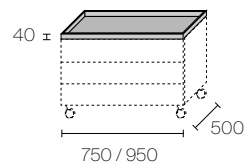

Mat for suspended drawer unit

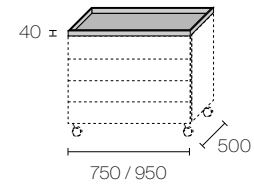

Mat for suspended drawer unit on wheels

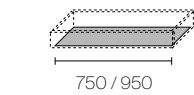
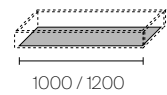

Linear shelf in glass or melamine

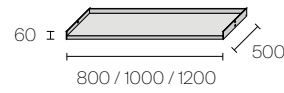

Corner shelf in glass or melamine

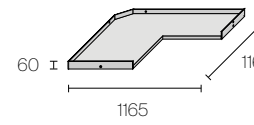

Shoe shelf in glass or melamine

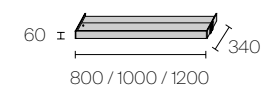

Adjustable wall thrust block

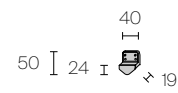

Clothes-hanger bar for linear shelf

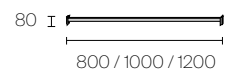

Clothes-hanger bar for corner shelf

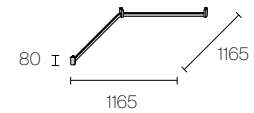

Telescopic clothes lift

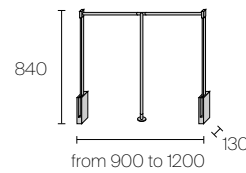

Pull-out shelf with tray in synthetic leather finishing

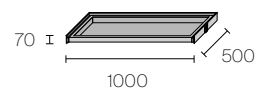

Veneered organizer

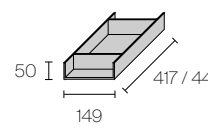

Organizer with double partition

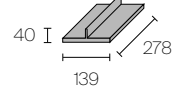

Watch holder

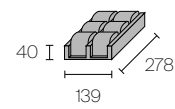

Concave box and box with jewels slots



Synthetic leather box

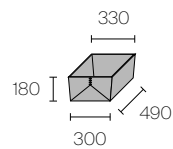

Synthetic leather tray

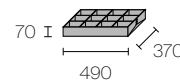

Wooden clothes hanger



Synthetic leather cabinet on wheels

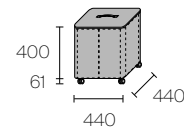

ACCESSORIES



1



2



3



4



5



6



7

1. Proposal B with accessories inside the organizer: 3 veneered organizers, 1 organizer with double partition, 1 watch holder, 2 concave boxes
2. Proposal B with accessories outside the organizer: 3 veneered organizers, 1 organizer with double partition, 1 watch holder, 2 concave boxes
3. Proposal A with accessories outside the organizer: 3 veneered organizers, 2 organizers with double partition, 1 concave box, 1 box with jewels slot
4. Proposal A with accessories inside the organizer: 3 veneered organizers, 2 organizers with double partition, 1 concave box, 1 box with jewels slot
5. Synthetic leather box
6. Synthetic leather tray
7. Synthetic leather cabinet on wheels

FINISHINGS

Structure

ALUMINIUM



Shelf and shoe shelf

TRANSPARENT GLASS

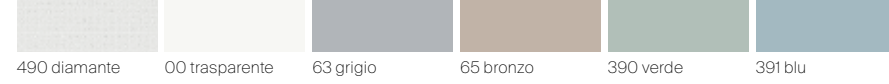

SATINATED GLASS

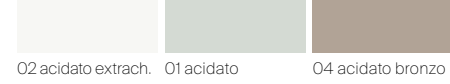

MELAMINE



SYNTHETIC LEATHER

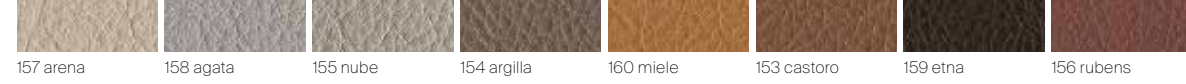

Drawer unit on wheels

LACQUERED GLASS METALIZED GLASS



DIAMANTE GLASS



MELAMINE



Melamine top with lining in synthetic leather for drawer units on wheels

SYNTHETIC LEATHER

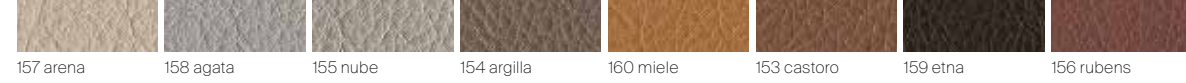

MELAMINE



Melamine suspended drawer units

MELAMINE



Box, tray and cabinet on wheels

SYNTHETIC LEATHER



Structure of suspended aluminium drawer units

ALUMINIUM

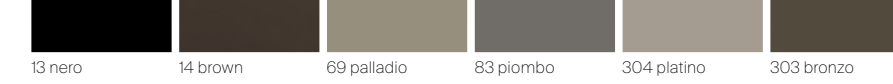

Aluminium drawer front

TRANSPARENT GLASS

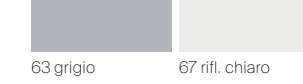

ALUMINIUM



SYNTHETIC LEATHER



Drawer internal cladding

MATERIAL FABRIC



LUX FABRIC

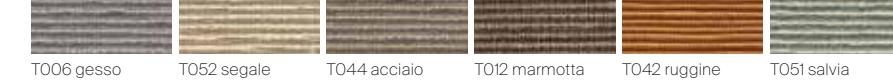

TECH FABRIC



SYNTHETIC LEATHER



INTERNAL MELAMINE\*

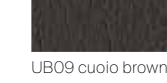

\* only available for drawer units on wheels and melamine suspended drawer units

Pull-out accessories and clothes-hanger bar

ALUMINIUM



SYNTHETIC LEATHER



Telescopic clothes lift

ALUMINIUM





DRESS BOLD IS A SYSTEM THOUGHT TO CREATE HIGHLY CUSTOMISABLE WALK-IN CLOSETS, WITH MADE-TO-MEASURE COMPOSITIONS IN LINEAR, CORNER AND C-SHAPED SOLUTIONS. THERE ARE TWO AESTHETIC POSSIBILITIES: WITH VISIBLE UPRIGHTS OR WITH WALL PANELS, AVAILABLE IN GLOSSY OR MATT LACQUERED GLASS, FABRIC, SYNTHETIC LEATHER, WOOD, MIRROR, LITECH, AND EQUIPPED WITH OPTIONAL UPPER LED LIGHTING.

IT Dress bold è un sistema per creare cabine armadio personalizzabili al massimo grado, con possibilità di composizioni su misura in soluzioni lineari, ad angolo e a C. Due le possibilità estetiche: con i montanti a vista o con pannelli a parete, disponibili in vetro laccato lucido o opaco, tessuto, similpelle, legno, specchio, Litech, e dotati di illuminazione a led superiore opzionale.

DE Dress bold ist ein System, mit dem sich begehbare Kleiderschränke in höchstem Maße individuell gestalten lassen, mit der Möglichkeit, maßgeschneiderte Kompositionen in linearen, Eck- und C-förmigen Lösungen zu schaffen. Es gibt zwei ästhetische Möglichkeiten: mit sichtbaren Stützen oder mit Wandpaneelen, die in glänzend oder matt lackiertem Glas, Stoff, Kunstleder, Holz, Spiegel, Litech und optional mit LED-Beleuchtung oben erhältlich sind.

FR Dress bold est un système permettant de créer des dressings personnalisables au plus haut point, avec la possibilité de créer des compositions sur mesure dans des solutions linéaires, d'angle et en forme de U. Deux possibilités esthétiques sont bien possibles: avec montants apparents ou panneaux muraux, disponibles en verre laqué brillant ou mat, en tissu, similicuir, bois, miroir, Litech, et en option un éclairage supérieur à LED.

ES Dress Bold es un sistema para crear vestidores muy personalizados, con la posibilidad de elaborar composiciones a medida en soluciones lineales, rinconeras y en forma de C. Hay dos posibilidades estéticas: con montantes vistos o con paneles de pared, disponibles en vidrio lacado lúcido u opaco, tela, polipiel, madera, espejo, Litech, y equipado con iluminación superior LED opcional.

RU Dress bold — это система для воплощения уникальных гардеробных, с возможностью разработки композиций по индивидуальному заказу с внедрением линейных, угловых и П-образных решений; и с двумя возможностями монтажа: с видимыми стойками или со стеновыми панелями, доступными в лакированном глянцевом или матовом стекле, ткани, искусственной коже, дереве, зеркале, Litech с дополнительной верхней светодиодной подсветкой.

汉语 Dress bold 系统旨在提供步入式衣橱最大程度的定制化。该系统依据定制尺寸可构建出线性、转角型和 C 型等解决方案。有两种美学风格的版本可供选择：可视立柱型或墙面板层型；LED 顶部照明可供选配；表面处理有亮面漆或哑光漆玻璃、布面、仿真皮革、木材、镜面、Litech 岩板 可供选择。





Structure: 303 bronzo  
Lux fabric back panels: T042 ruggine  
Base, shelves and cabinets: 07 melaminico olmo  
Clothes-hanger bars and shoe shelves  
in synthetic leather: 153 castoro

In this photo  
Sliding doors: Velaria  
Drawer unit: Self bold  
Coffee table: Planet  
Door: Moon



Structure: 14 brown  
Glass back panels: 99 caffè opaco  
Floor bases and shelves: 25 melaminico larice carbone  
Accessories in synthetic leather: 153 castoro



Structure: 83 piombo  
Material fabric back panels: T019 papiro  
Floor bases, shelves and drawer units:  
09 melanimico rovere grigio  
Clothes-hanger bars and pull-out accessories  
in synthetic leather: 154 argilla

In this photo  
Sliding doors: Graphis plus



EN An ideal level of lighting, a customisation of light intensity and quality through the use of LED sources which can be positioned under the plinth on the floor, under the shelves and under the shoe shelf, or in the upper part of the back panels available in fabric, synthetic leather, wood, lacquered or mirror glass, and Litech. The inclined shoe shelf is fitted with an invisible connection, without screws or visible joints for absolute aesthetic integrity.

IT Un livello di illuminazione ideale, una personalizzazione dell'intensità luminosa e delle qualità della luce grazie all'utilizzo di sorgenti a led che possono essere posizionate sotto il basamento a terra, sotto la mensola e sotto i ripiani portascarpe, oppure nella parte superiore dello schienale disponibile in tessuto, similpelle, legno, vetro laccato o specchio e Litech. Il ripiano portascarpe inclinato è dotato di un innesto rapido ed invisibile, senza viti né giunzioni a vista per una pulizia estetica assoluta.

DE Dank der Verwendung von LED-Lichtquellen, die am Boden, unter den Ablagen und unter den Schuhfächern oder im oberen Teil der Rückwand angebracht werden, können Sie Lichtintensität und Lichtqualität optimal anpassen. Die Leuchten sind in Stoff, Kunstleder, Holz, lackiertem Glas oder Spiegel und Litech erhältlich. Das abgeschrägte Schuhregal hat eine praktische und unsichtbare Verbindung, die ohne Schrauben oder sichtbare Fugen auskommt und so für absolute ästhetische Ordnung sorgt.

FR Un niveau d'éclairage idéal, une personnalisation de l'intensité lumineuse et de la qualité de la lumière grâce à l'utilisation d'ampoules LED qui peuvent être placées au sol sous le socle, sous l'étagère et sous les étagères porte-chaussures, ou en partie haute du panneau arrière disponible en tissu, similicuir, bois, verre laqué ou miroir et Litech. L'étagère inclinée porte-chaussures est équipée d'un système d'assemblage rapide et invisible, sans vis ni joints apparents pour une propreté et une esthétique absolues.

ES Un nivel de iluminación ideal, una personalización de la intensidad luminosa y la calidad de la luz gracias al uso de fuentes LED que pueden colocarse debajo de la base (en el suelo), debajo de la estantería y debajo de los zapateros, o en la parte superior de la parte trasera disponible en tela, polipiel, madera, vidrio lacado o espejo y Litech. El zapatero inclinado está equipado con una conexión rápida e invisible, sin tornillos ni juntas visibles, de manera que ofrece una estética de simplicidad absoluta.

RU Идеальный уровень освещения, регулировка интенсивности и качества света благодаря использованию светодиодных источников, которые можно разместить под цоколем, под полкой и под обувницами, или в верхней части стеновой панели; отделка может быть выполнена из ткани, искусственной кожи, дерева, лакированного стекла, зеркала или Litech. Наклонная полка для обуви оснащена невидимым быстроразъемным соединением без винтов и видимых стыков, что обеспечивает полную эстетическую чистоту.

汉语 因采用 LED 灯源·照明度和光线品质皆能达到理想的客制化程度;其可装设于落地底座、层板下方和鞋架层板的下方,亦可装设于背板上部;表面处理有布面、仿真皮革、木材、烤漆玻璃、镜面或 Litech岩板 可供选择。斜式鞋架层板采用的快速插入式隐形连接件,无螺钉和普通可视连接件,实现绝对的美观整洁度。



Structure: 83 piombo  
Material fabric back panels: T019 papiro  
Floor bases, shelves and drawer units:  
09 melanimico rovere grigio  
Clothes-hanger bars, shoe shelf and  
pull-out accessories in synthetic leather: 154 argilla

In this photo  
Coffee table: Planet



Structure: 303 bronzo  
Lux fabric back panels: T012 marmotta  
Floor base, shelves and drawer units:  
07 melanimico olmo  
Clothes-hanger bars and  
accessories in synthetic leather: 153 castoro

Version with wall uprights

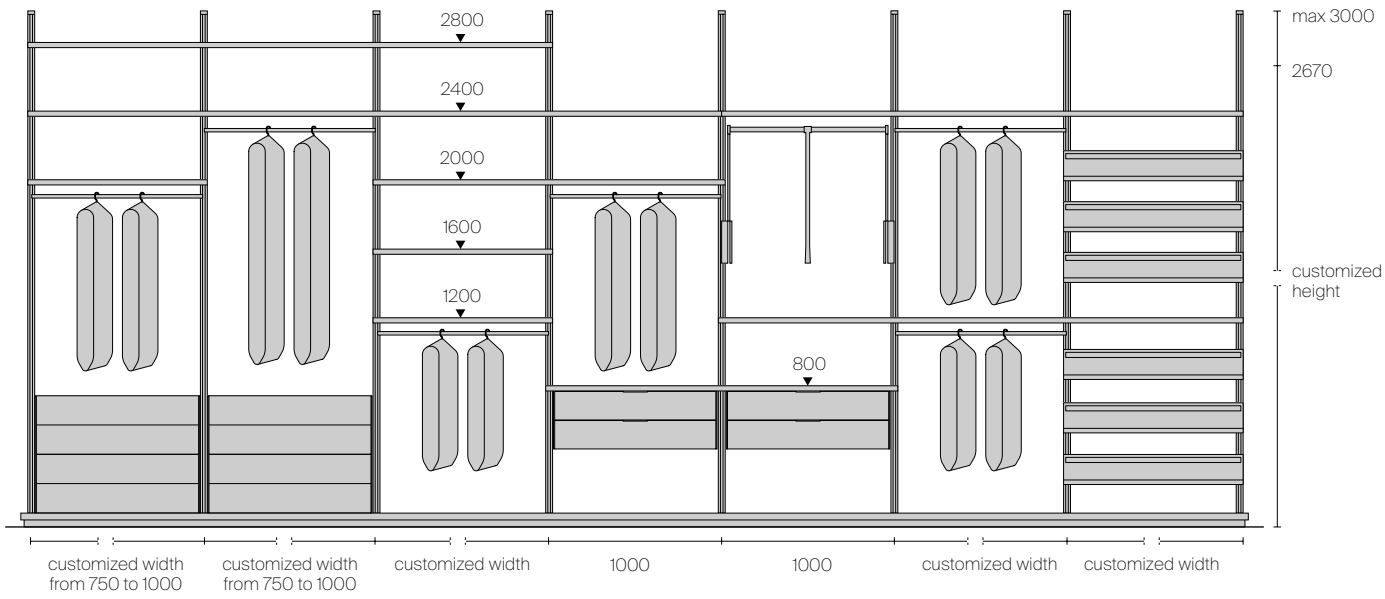

Version with wall uprights and back panels in fabric, synthetic leather, melamine, Litech, lacquered or mirror glass

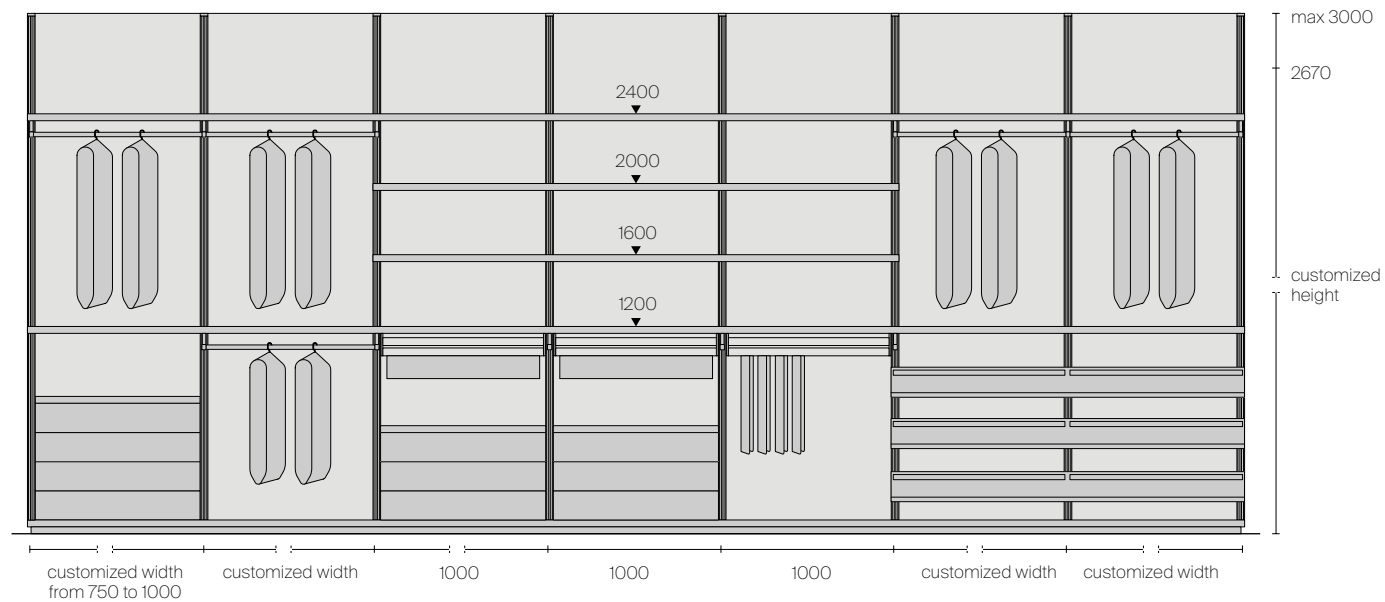

1. Back panels in T018 tabacco Material fabric, 14 brown aluminium structure
2. Back panels in melamine 25 larice carbone, 14 brown aluminium structure
3. Back panels in lacquered glass 99 caffè, 14 brown aluminium structure
4. Back panels in 153 castoro synthetic leather, 14 brown aluminium structure
5. Back panels in Litech G002 moka, 14 brown aluminium structure
6. Wall uprights in aluminium 14 brown, without back panels

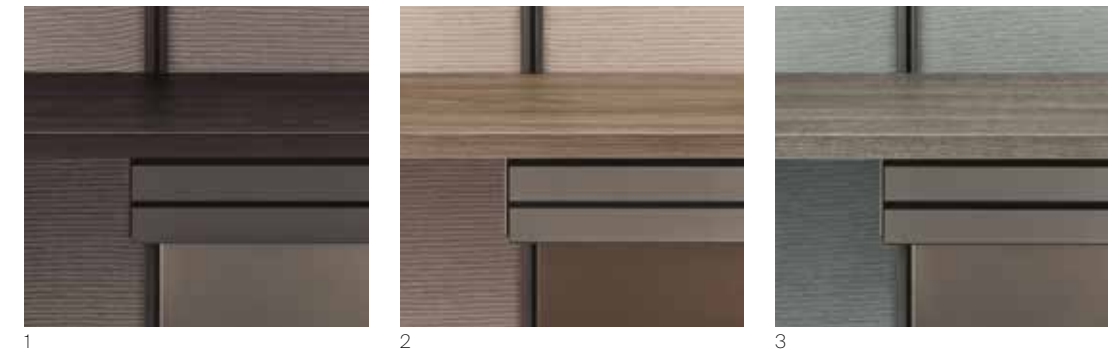

1. Back panels in T044 acciaio Lux fabric, 14 brown aluminium structure, shelves in melamine 25 larice carbone, trays in synthetic leather 154 argilla, glass fronts in 99 caffè opaco
2. Structure in 303 bronzo, back panels in T052 segale Lux fabric, shelves in melamine 07 olmo, trays in synthetic leather 153 castoro, glass fronts in 136 bronzo opaco
3. Structure in 83 piombo, back panels in T051 salvia Lux fabric, shelves in melamine 09 rovere grigio, trays in synthetic leather 154 argilla, glass fronts in 127 piombo opaco

EN A system which allows to personalize walk-in closets with custom-made linear, corner and C-shaped compositions. Two aesthetic possibilities are available: with visible uprights or with wall back panels, available in lacquered glass, wood, fabric, synthetic leather and Litech. The accessories can be freely positioned on the wall upright, thanks to the patented expansion fixing system, without holes.

IT Un sistema per creare cabine armadio personalizzabili, con possibilità di composizioni su misura in soluzioni lineari, ad angolo e a C. Due le possibilità estetiche: con i montanti a vista o con pannelli a parete, disponibili in vetro laccato, specchio, melaminico, tessuto, similpelle e Litech. Gli accessori sono liberamente posizionabili lungo il montante a parete, grazie al sistema brevettato di fissaggio ad espansione senza fori.

DE Das System erlaubt, persönliche Schrankräume mit lineare sowohl als Ecke Loesungen, immer nach Mass, zugestalten. Zwei sind die vefuegbare aesthetische Moeglichkeiten: mit sichtbaren Wandpfosten oder mit Wandpaneelen, aus lackiertem Glas, Holz und mit Stoff, Kunstleder und Litech. Die Zubehoeren koennen frei auf den Pfosten mit dem patentierten Spreizmechanismus ohne Loecher gestellt werden.

FR Dress bold est le système pour personnaliser au mieux les dressings avec des compositions linéaires ou à angle, toujours sur mesure. Deux sont les possibilités esthétiques: avec les montants à vue ou avec les panneaux murales de fond, disponibles en verre laqué, bois, tissu, similicuir et Litech. Les accessoires sont librement positionnables sur le montant mural grâce au système breveté de fixation à expansion sans trous.

ES Dress bold es un sistema para realizar vestidores personalizable al máximo grado, con la posibilidad de composiciones a medida en soluciones lineales, angulares y a C. Las posibilidades estéticas son dos: con montantes a vista o con paneles a pared, disponibles en cristal lacado, en madera, tejido, simil cuero y Litech. Los accesorios son libremente posicionables en los montantes a pared, gracias al sistema patentado de fijación a expansión sin agujeros.

RU Dress bold — это система для воплощения уникальных гардеробных, с возможностью разработки композиций по индивидуальному заказу с внедрением линейных, угловых и П-образных решений; и с двумя возможностями монтажа: с видимыми стойками или со стеновыми панелями, доступными в лакированном стекле, зеркале, меламиновом покрытии, ткани, искусственной коже и Litech. Комплекующие можно свободно размещать вдоль стены благодаря запатентованной системе крепления, не имеющей перфорации.

汉语 Dress bold 系统旨在打造定制化步入式衣橱。该系统依据定制尺寸可构建出线性、转角型和 C 型等解决方案。有两种美学风格的版本可供选择: 可视立柱型或墙面层板型; 有烤漆玻璃、镜面、三聚氰胺板、布面、仿真皮革和 Litech 岩板 可供选择。有赖于无孔伸缩式的专利固定系统, 各式家具配件得以沿着墙面立柱自由配置位置。



1



2

1. Detail of back panel in Material fabric T019 papiro with upper led lighting system, shelf in melamine 09 rovere grigio with integrated led lighting. Upright and shelf holder in lacquered aluminium 83 piombo, clothes-hanger bar covered with synthetic leather 154 argilla
2. Floor base in synthetic leather 154 argilla with extruded aluminium perimeter profile. Optional led lighting
3. Shoe shelf in synthetic leather 154 argilla with extruded aluminium perimeter profile. Optional led lighting
4. Shoe shelf in melamine 09 rovere grigio. Optional led lighting



3



4

TECHNICAL DESCRIPTION

EN The Dress bold system is characterized by one-running synthetic leather and melamine shelves with honeycomb wooden structure 40 mm thick and floor-bases with continuous aluminium frame.

FR Le système Dress bold est caractérisé par des étagères de similicuir et mélamine continues avec structure en bois en nid d'abeille de 40 mm et des bases au sol avec cadre en aluminium continu.

ES El sistema Dress bold se caracteriza por los estantes en simil cuero y melamina continuos con estructura en alveolar de 40 mm de espesor y por las bases con marco en aluminio continuo.

DE Charakteristische Merkmale der Kollektion Dress bold sind die 40 mm starken, durchgehenden, mit Melamin- und Kunstlederbezug Fachboden in Wabenstruktur und die Basisboden mit durchgehendem Rahmen aus Aluminium.

RU Система Dress bold характеризуется сплошными полками из многослойной древесной панели толщиной 40 мм с покрытием из меламина или из искусственной кожи и сплошными алюминиевыми цоколями.

汉语 Dress bold 系统的特色为连续的大件层板，材质为三聚氰胺板或仿真皮革，搭配 40 毫米的木蜂窝板结构以及铝制连续框架底座。

COMPONENTS AND ACCESSORIES

Glass, mirror or Litech panel

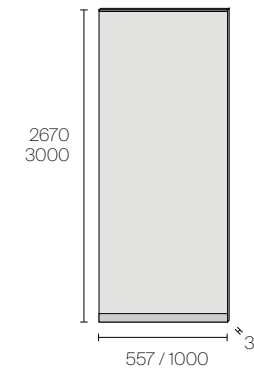

Melamine, fabric or synthetic leather panel

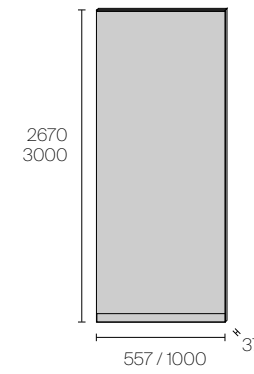

Upper led lighting for panel

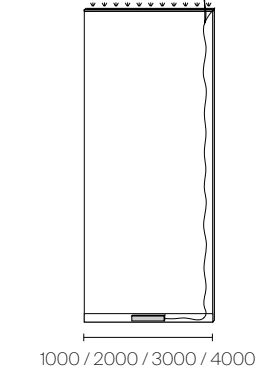

Wall upright

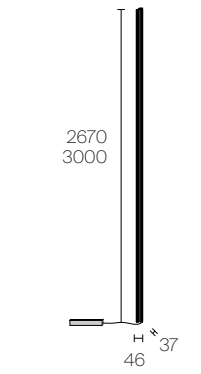

Synthetic leather shelf with extruded aluminium profile



Melamine shelf



Shelf holder, clothes-hanger bar in aluminium with optional covering in synthetic leather

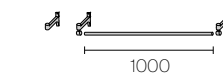

Led lighting for shelves



Synthetic leather shoe shelf with extruded aluminium profile

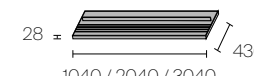

Melamine shoe shelf



Inclined shoe shelf holder

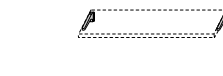

Led lighting for shoe shelves



Floor base in synthetic leather finishing with profiles and skirting in aluminium

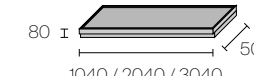

Floor base in melamine with aluminium skirting

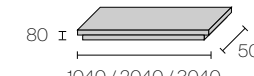

Led lighting for floor bases







1



2

1. Pull-out tray with organizer and small tray in synthetic leather. Lacquered glass front
2. Pull-out tray with organizer and big tray in synthetic leather. Lacquered glass front
3. Pull-out tray and trousers rack in synthetic leather. Lacquered glass front
4. Telescopic clothes lift
5. Synthetic leather box
6. Synthetic leather tray



3



4



5



6

Melamine drawer unit on floor base with four drawers

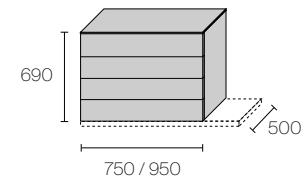

Melamine drawer unit on floor base with three drawers

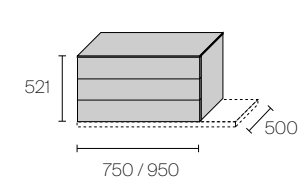

Optional melamine top with synthetic leather lining

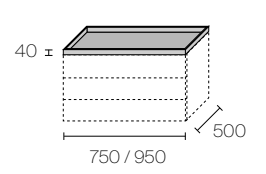
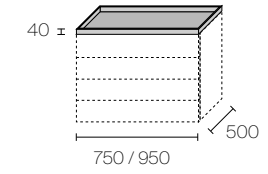

Melamine drawer unit on wheels with four drawers

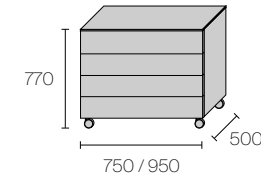

Melamine drawer unit on wheels with three drawers

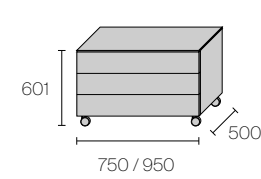

Suspended melamine drawer unit

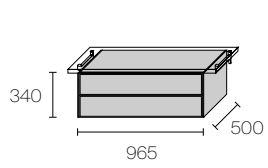

Synthetic leather mat for internal lining

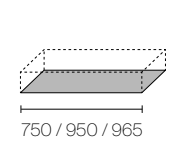

Pull-out tray and small tray in synthetic leather with lacquered glass front

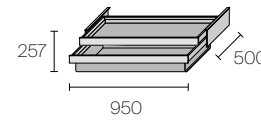

Pull-out tray and big tray in synthetic leather with lacquered glass front

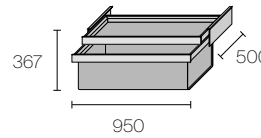

Pull-out tray and trousers rack in synthetic leather with lacquered glass front

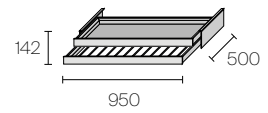

Pull-out tray with organizer and small tray in synthetic leather. Lacquered glass front

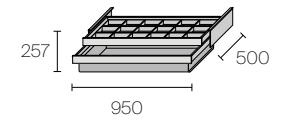

Pull-out tray with organizer and big tray in synthetic leather. Lacquered glass front

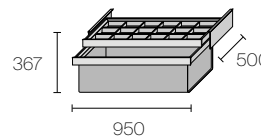

Pull-out tray with organizer and trousers rack in synthetic leather. Lacquered glass front

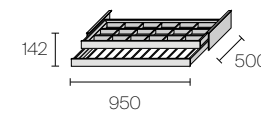

Telescopic clothes lift

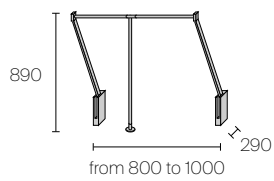

Synthetic leather cabinet on wheels

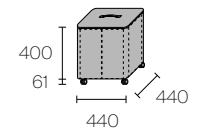

Synthetic leather box

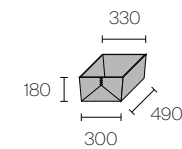

Synthetic leather tray

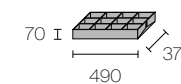

Wooden clothes hanger



Linear composition

Calculation of the length of the shelf A  
shelf W = minimum opening W - 50 mm

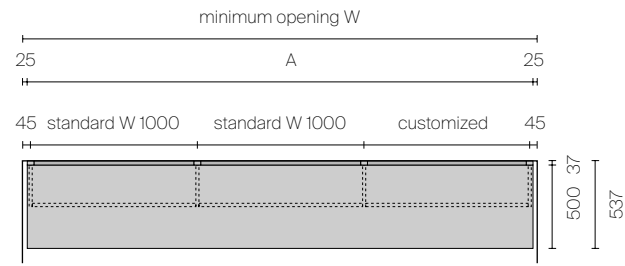

Corner composition

Calculation of the length of the shelf A  
shelf W = minimum opening W - 62 mm  
Calculation of the length of the shelf B  
shelf W = minimum opening W - 562 mm

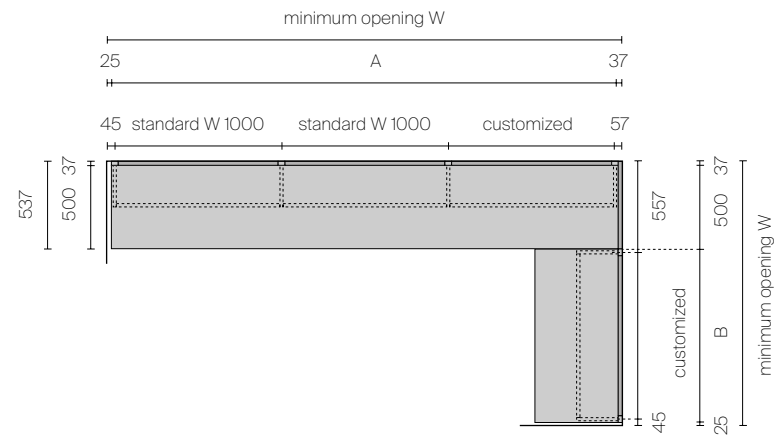

C-shaped composition

Calculation of the length of the shelf A  
shelf W = minimum opening W - 74 mm  
Calculation of the length of the shelf B  
shelf W = minimum opening W - 562 mm

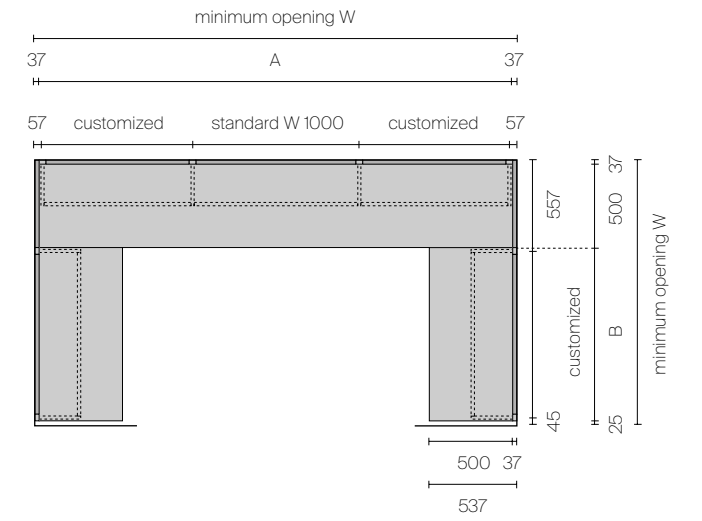

Calculation of the length of the shelf A  
shelf W = minimum opening W - 1074 mm  
Calculation of the length of the shelf B  
shelf W = minimum opening W - 62 mm

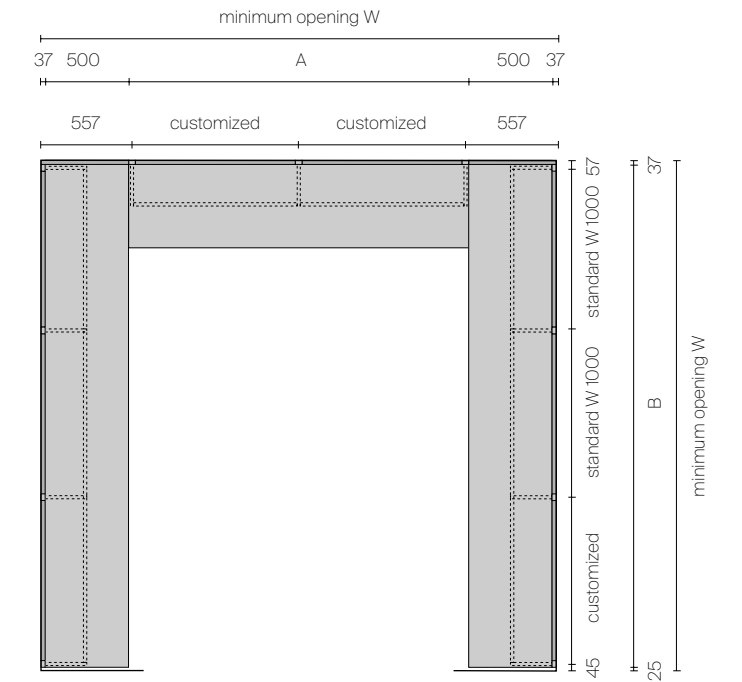

Structure and accessories

ALUMINIUM

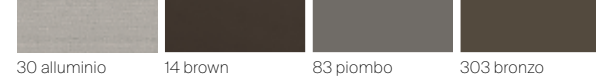

Floor base, shelf, drawer unit and shoe shelf

SYNTHETIC LEATHER

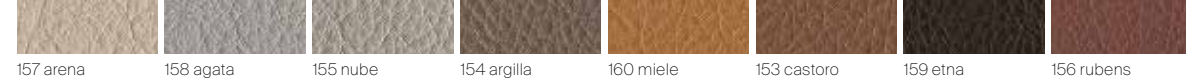

MELAMINE



Drawer unit interior

INTERNAL MELAMINE



Clothes-hanger bar, pull-out shelf and accessories

ALUMINIUM

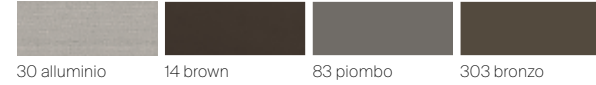

ECOLORSYSTEM LACQUERED MATT GLASS\*

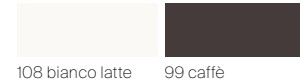

ECOLORSYSTEM METALIZED MATT GLASS\*

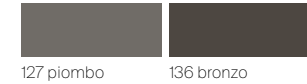

SYNTHETIC LEATHER



\* only available for pull-out shelves

Box, tray, cabinet on wheels

SYNTHETIC LEATHER

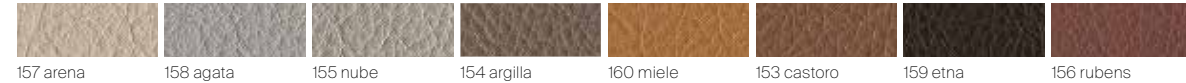

Telescopic clothes lift

ALUMINIUM

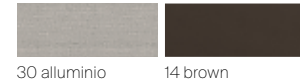

Back panel

LACQUERED GLASS



METALIZED GLASS



REFLEX GLASS



SAHARA GLASS



SAHARA METALIZED GLASS

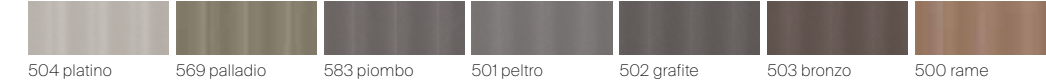

DIAMANTE GLASS



NEUTRAL GLASS



LITECH



MATERIAL FABRIC



LUX FABRIC

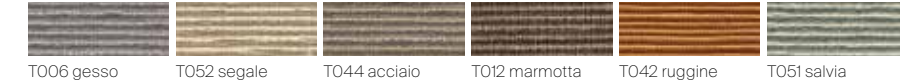

TECH FABRIC



SYNTHETIC LEATHER



MELAMINE





ABACUS TRANSFORMS THE WALK-IN CLOSET IN A SYNTHETIC LEATHER ROOM, WHERE HORIZONTAL ELEMENTS OF MINIMUM THICKNESS AND MAXIMUM GEOMETRIC RIGOUR ARE INSERTED. A DESIGN INTERPRETED WITH A MINIMALIST AND COHERENT STYLE IN EVERY DETAIL, FROM THE ACCESSORIES TO THE CABINETS ORGANISING THE CLOSET SPACE, AVAILABLE IN SYNTHETIC LEATHER, FABRIC, LITECH, GLOSSY AND MATT LACQUERED SAHARA OR DIAMANTE GLASS.

IT Con Abacus, la cabina armadio diventa una stanza di similpelle, in cui si innestano elementi orizzontali di minimo spessore e dal massimo rigore geometrico. Un progetto interpretato con uno stile minimale e coerente in ogni dettaglio, dagli accessori ai contenitori per l'organizzazione dello spazio armadio, disponibile in similpelle, tessuto, Litech, vetro laccato lucido e opaco, sahara o diamante.

DE Mit Abacus wird der begehbare Kleiderschrank zu einem Raum aus Kunstleder, in den horizontale Elemente von minimaler Stärke und maximaler geometrischer Strenge eingefügt werden. Ein minimalistisch interpretiertes Design, das sich in jedem Detail widerspiegelt, von den Accessoires bis hin zu den Behältern für die Organisation des Kleiderschranks, erhältlich in Kunstleder, Stoff, Litech, glänzend und matt lackiertem Glas, Sahara oder Diamante.

RU С системой Abacus гардеробная превращается в комнату из искусственной кожи, в которую вставляются горизонтальные элементы минимальной толщины и максимальной геометрической строгости. Дизайн в стиле минимализма, который прослеживается в каждой детали, от комплектующих до систем хранения для организации пространства гардероба, доступен в искусственной коже, ткани, Litech, лакированном глянцевом или матовом стекле, в стекле sahara или diamante.

FR Avec Abacus, le dressing devient une pièce en similicuir, dans laquelle s'insèrent des éléments horizontaux d'épaisseur minimale et à la rigueur géométrique maximale. Un projet interprété dans un style minimaliste et cohérent jusque dans les moindres détails, des accessoires aux rangements pour organiser l'espace du placard, disponibles en similicuir, tissu, Litech, verre laqué brillant et mat, sahara ou diamante.

ES Con Abacus, el vestidor se convierte en una habitación de polipiel, en la que se insertan elementos horizontales de mínimo espesor y máximo rigor geométrico. Un proyecto interpretado con un estilo minimalista y coherente en cada detalle, desde los complementos hasta los contenedores para organizar el espacio del armario, disponibles en polipiel, tejido, Litech, cristal lacado brillante y mate, sahara o diamante.

汉语 Abacus 以仿真皮革打造步入式衣橱空间，在这其中，极轻薄的各式部件横向毗连接续，构建出最严谨的几何。每道细节中的极简风格与和谐调性皆诠释了这项设计，各式配件和收纳物件完善空间组织性；表面处理有仿真皮革、布面、Litech岩板、亮光和哑光烤漆玻璃、Sahara 和 Diamante 玻璃可供选择。



Structure: 303 bronzo  
Shelves: 303 bronzo  
Synthetic leather panels: 154 argilla  
Pullover holder: 07 melaminico olmo  
Clothes-hanger bar: stainless steel covered with  
synthetic leather 154 argilla

In this photo  
Sliding doors: Graphis plus  
Coffee table: Tray

EN A walk-in closet becoming a system to decorate workspaces or commercial shops and showrooms: Abacus is an always evolving solution, in which the accessories and the sophisticated and elegant materials, like the exclusive synthetic leather, ensure elegance and flexibility in any context.

IT Una cabina armadio che diventa sistema per arredare spazi di lavoro o retail come negozi o showroom: Abacus è una soluzione in continua evoluzione nella quale gli accessori e i materiali sofisticati ed eleganti, come l'esclusiva similpelle, assicurano eleganza e flessibilità in qualsiasi contesto.

DE Ein Ankleidessystem, das Einrichtungssystem fuer Geschaeft oder Showroom sein kann: Abacus ist eine Loesung auf staendiger Entwicklung, wo exklusiven, ausgekluegelten und eleganten Zubehoeren und Materialien, wie das exclusive Kunstleder, Eleganz und Flexibilitaet in jeder Situation versichern.

FR Le dressing qui devient un système pour le projet des espaces de travail ou des magasins commerciaux ou des showroom: Abacus est une solution en évolution constante, dans laquelle les accessoires et les matériaux sophistiqués et élégants, comme l'exclusive similicuir, offrent élégance et flexibilité dans tout le contexte.

ES Un vestidor que se convierte en el sistema para amueblar espacios de trabajo o comerciales tales como tiendas y exposiciones: Abacus es una solución en continua evolución en la que los accesorios y los materiales sofisticados y elegantes, como el exclusivo simil cuero, proporcionan elegancia y flexibilidad en cualquier contexto.

RU Гардеробная, которая становится системой мебелировки рабочих или торговых помещений, например, в магазинах или выставочных залах — Abacus — это постоянно расширяющееся решение, характеризующееся утонченными и элегантными элементами и материалами, например, эксклюзивный кожзаменитель, и обеспечивающими элегантность и гибкость в любом контексте.

汉语 Abacus 步入式衣橱发展而成的系统用于打造如商店或展厅等办公和零售空间: 它是一个不断演进的解决方案, 其精典典雅的各式配件与材质, 如独家的仿真皮革, 为任何空间提供典雅调性和自由灵活度。



Structure: 303 bronzo  
Shelves: 303 bronzo  
Synthetic leather panels: 154 argilla  
Pullover holder: 07 melaminico olmo  
Clothes-hanger bar: stainless steel covered with synthetic leather 154 argilla

In this photo  
Sliding doors: Graphis plus



Structure: 303 bronzo  
Back panels in synthetic leather: 154 argilla  
Pullover holder: 07 melaminico olmo

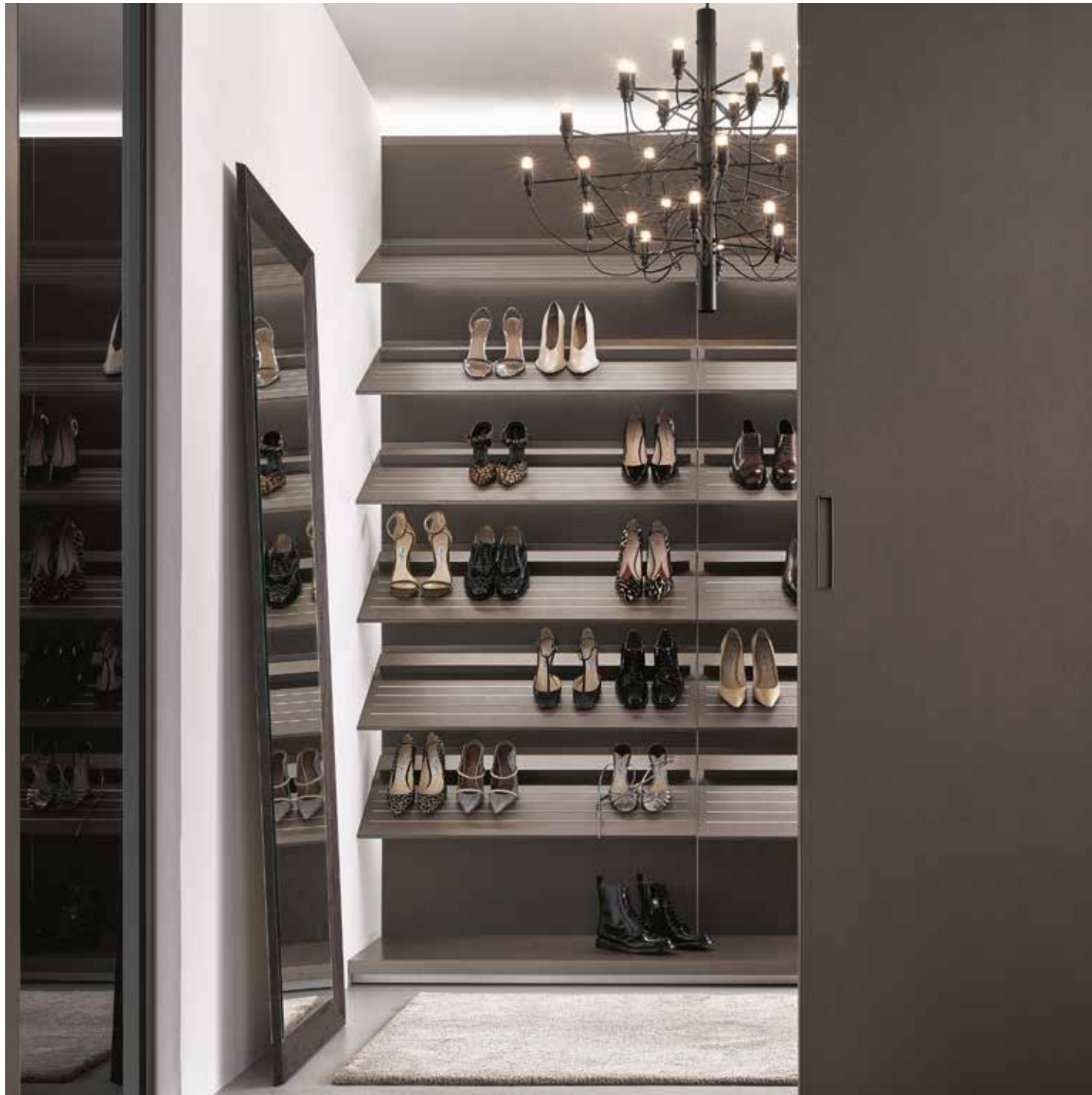





Structure: 30 alluminio  
Shelves: 57 tortora  
Fronts, back panels and drawer units: 106 tortora opaco  
Pull-out accessories in synthetic leather: 154 argilla  
Clothes-hanger bar in stainless steel covered with synthetic leather 154 argilla





EN Between technology and suggestiveness, new stylistic values for environments dedicated to personal space. The Abacus system takes Rimadesio's glass aesthetic towards new possibilities of interpretation: the walk-in closet becomes a room of lacquered glass where extremely thin and rigorously geometric horizontal elements are placed. A design that is capable of combining functionality and mood from a lighting point of view, thanks to the built-in lighting system on the upper part of the wall panels, and the led spotlights on the shelves.

IT Fra tecnologia e suggestione, nuove valenze stilistiche per gli ambienti dedicati all'ordine personale. Il sistema Abacus porta l'estetica del vetro Rimadesio verso nuove possibilità di interpretazione: la cabina armadio diventa una stanza di vetro laccato, in cui si innestano elementi orizzontali di minimo spessore e dal massimo rigore geometrico. Un progetto che anche dal punto di vista illuminotecnico è in grado di coniugare funzionalità e mood, grazie al sistema di illuminazione integrato nella parte superiore dei pannelli a muro, che si affianca alle lampade a led delle mensole.

DE Zwischen Technologie und Anregung, neue stylistische Werte für personale Umgebungen. Das Abacus-System bringt die Ästhetik des Glases Rimadesio hin zu neuen Interpretationsmöglichkeiten: der Schrank wird zu einem Raum aus lackiertem Glas, wo horizontalen Elemente der Mindestdicke und geometrische Strenge das Heim gestalten. Ein Projekt, dass aus der Sicht Beleuchtung, die Fähigkeit hat, Funktion und Stimmung zu kombinieren, dank zu der oberen Beleuchtung, in den Wandpaneelen integriert, und der Led Beleuchtung der Fachboden.

FR Entre technologie et suggestion, nouvelles propositions stylistiques pour les ambiances dédiées au rangement. Nouvelles interprétations de l'esthétique du verre Rimadesio avec le système Abacus: le dressing devient une vraie pièce de verre laqué avec le mariage d'éléments horizontaux d'épaisseur très réduit avec un rigueur géométrique important. Un projet, que même sous un point de vue de l'éclairage, permet de marier fonctionnalité et humeur, grâce au système d'éclairage intégré dans la partie supérieure des panneaux au mur en plus de lampes led des étagères.

ES Entre tecnología y sugestión, nuevos valores estilísticos para los ambientes dedicados a los entornos personales. El sistema Abacus lleva la estética del cristal Rimadesio hacia nuevas posibilidades de interpretación: el vestidor se convierte en una habitación de cristal lacado, donde se mezclan elementos horizontales de espesor mínimo y del máximo rigor geométrico. Un proyecto que también desde el punto de vista de iluminación técnica tiene la capacidad de combinar funcionalidad, gracias al sistema de iluminación integrado en la parte superior de los paneles a pared, que se adjunta a las lámparas led de los estantes.

RU Сочетание технологий и вариативности — новые стилистические решения для комнат, посвященные организации личного пространства. Стекло Rimadesio приобретает новые возможности воплощения в система Abacus: гардеробная превращается в комнату из лакированного стекла, в которую вписаны горизонтальные элементы минимальной толщины и максимальной геометрической строгости. Проект сочетает функциональность и настроение, благодаря системе освещения, встроенной в верхнюю часть стеновых панелей, наряду со светодиодными лампочками подсветки полок.

汉语 技术与美感交织成新的风格意义，致力于打造以人为本的空间。Abacus 系统将 Rimadesio 玻璃美学演绎出新的可能性：步入式衣橱转换成一方以烤漆玻璃打造的空间，在这其中，极轻薄的各式部件横向毗连接续，构建出最严谨的几何。它亦是一项从照明技术角度出发的设计，其照明系统设置于层板 LED 灯具两侧的上部壁板当中，将功能性与人类情绪串联。

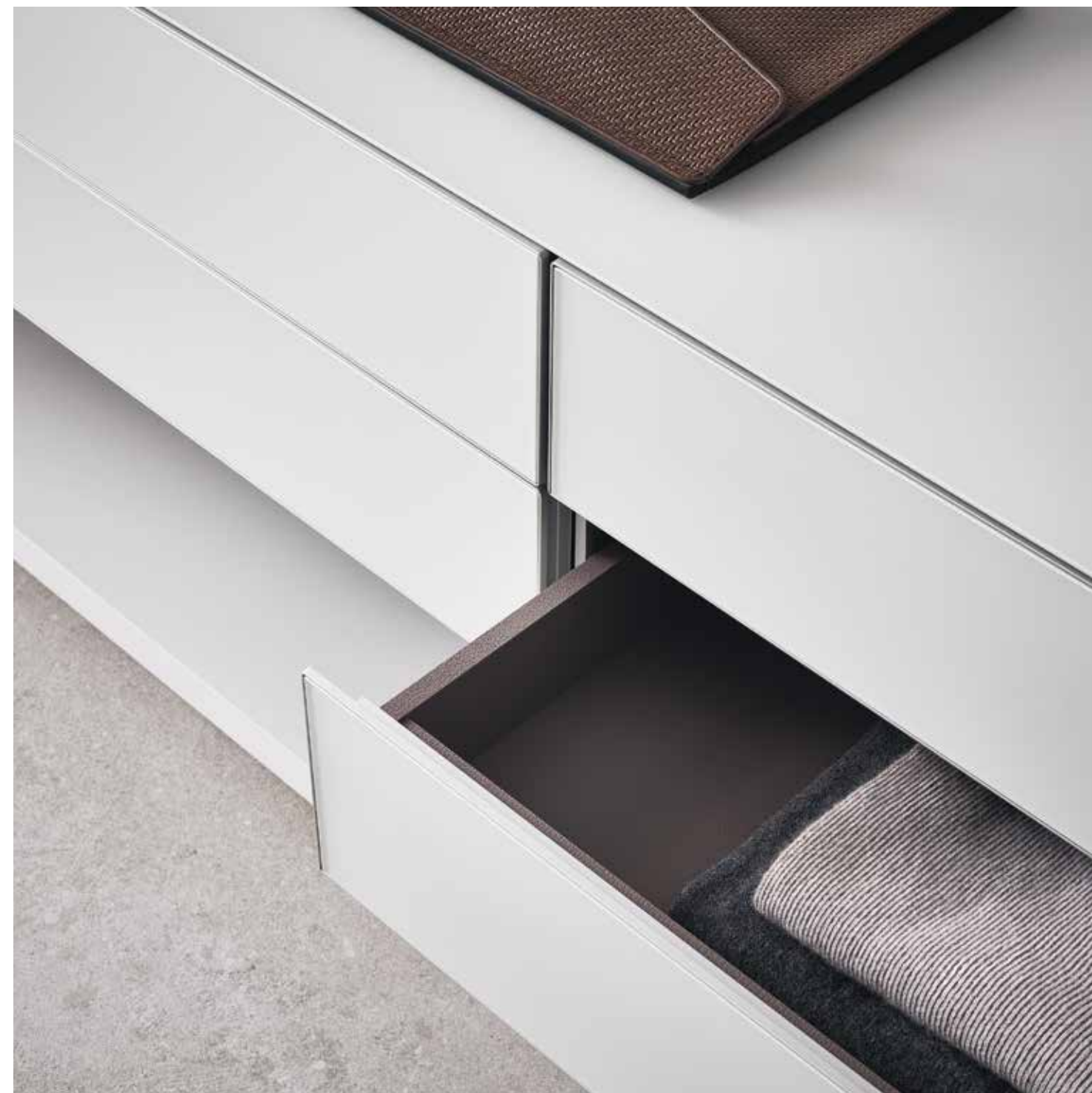

Structure: 16 bianco latte  
Drawer units: 108 bianco latte opaco  
Drawers interior: UB09 melaminico cuoio brown

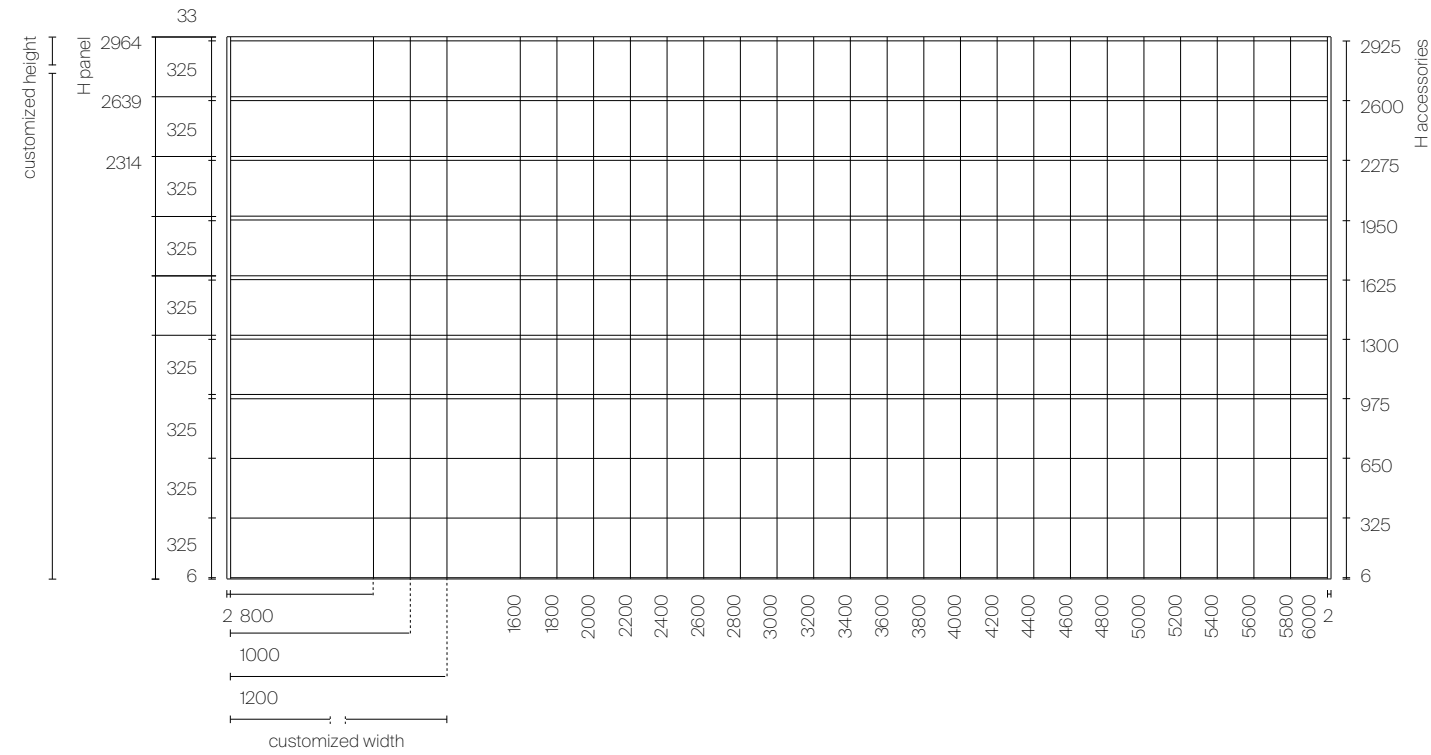

TECHNICAL DESCRIPTION

EN The modularity of the Abacus system is based on wall panels in different materials of the collection, available in four widths and three heights. Reduction to size in width and height is also offered. A dimensional scheme that ensures maximum design freedom, enabling the compositions to be fitted into any type of space.

IT La modularità del sistema Abacus si basa su pannelli a parete in diversi materiali della collezione disponibili in quattro larghezze e tre altezze. È inoltre previsto il taglio a misura in larghezza e altezza. Uno schema dimensionale che assicura la massima libertà progettuale, per consentire di inserire le composizioni in ogni tipo di spazio.

DE Das modulare System von Abacus basiert auf Wandpaneelen aus verschiedenen Materialien aus der Kollektion, die in vier Breiten und drei Höhen erhältlich sind. Es ist möglich, sie in der Breite und Höhe nach Maß zuzuschneiden. Ein Maßkonzept, das für maximale Gestaltungsfreiheit sorgt, sodass sich die Kompositionen in jeden Raum einfügen.

FR La modularité du système Abacus repose sur des panneaux muraux disponibles dans différents matériaux de la collection, en quatre largeurs et trois hauteurs. Une découpe sur mesure en largeur et en hauteur est également prévue. Un schéma avec les dimensions garantit une liberté de conception maximale, pour permettre aux compositions de s'intégrer dans tout type d'espace.

ES La modularidad del sistema Abacus se basa en paneles murales de diferentes materiales de la colección disponibles en cuatro anchuras y tres alturas. También está disponible con anchura y altura a medida. Un esquema dimensional que garantiza la máxima libertad de diseño, para permitir que las composiciones se puedan incorporar en cualquier tipo de espacio.

RU Модульность системы Abacus обеспечивается стеновыми панелями из различных материалов в четырех вариантах ширины и трех вариантах высоты. Также предусмотрена возможность урезки по ширине и высоте. Размерная схема обеспечивает максимальную свободу проекта, благодаря чему композиции могут вписаться в любой тип пространства.

汉语 Abacus 模块化系统奠基于该系列中采用各式材质打造的墙板,共有 4 种宽度和 3 种高度可选。除此之外,也可根据定制尺寸裁切宽度和高度。该尺寸方案确保最大的设计灵活性,旨在将各式组合件配置于任何类型的空间中。

Linear composition

Calculation of the length of the shelf and of panel A  
shelf W / panel W = minimum opening - 1000 - 1000 - 40 mm

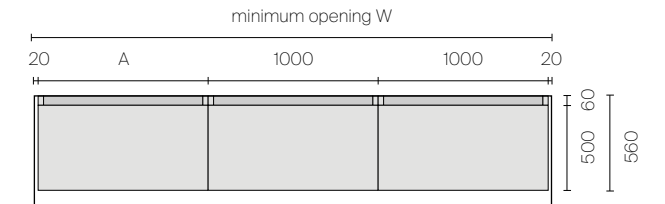

Corner composition

Calculation of the length of the shelf and of panel A  
shelf W / panel W = minimum opening W - 1000 - 1000 - 80 mm  
Calculation of the length of the shelf and of panel B  
shelf W / panel W = minimum opening W - 580 mm

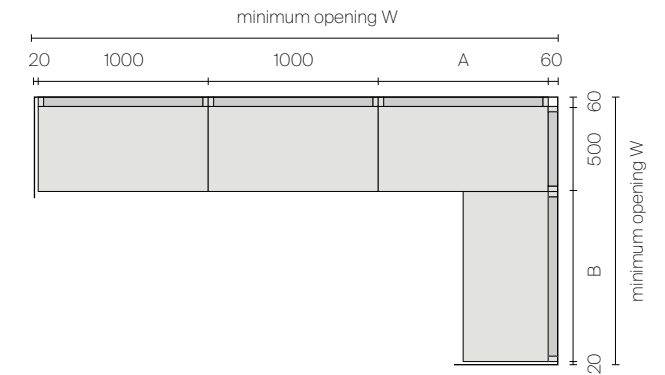

C-shaped composition

Calculation of the length of the shelf A and of panel  
shelf W / panel W = minimum opening W - 1000 - 1000 - 120 mm  
Calculation of the length of the shelf B and of panel  
shelf W / panel W = minimum opening W - 580 mm

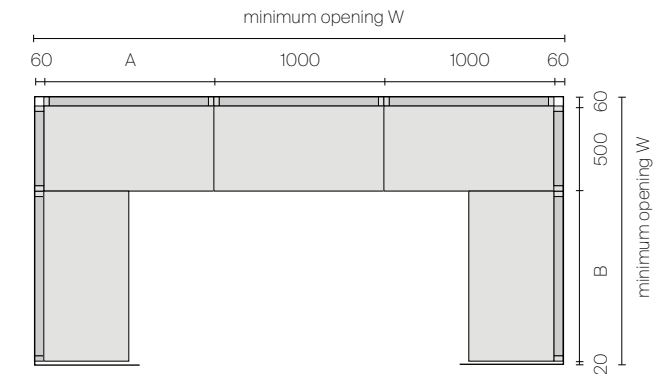

Calculation of the length of the shelf and of panel A  
shelf W / panel W = minimum opening W - 1000 - 555 - 560 mm  
Calculation of the length of the shelf and of panel B  
shelf W / panel W = minimum opening W - 1000 - 80 mm

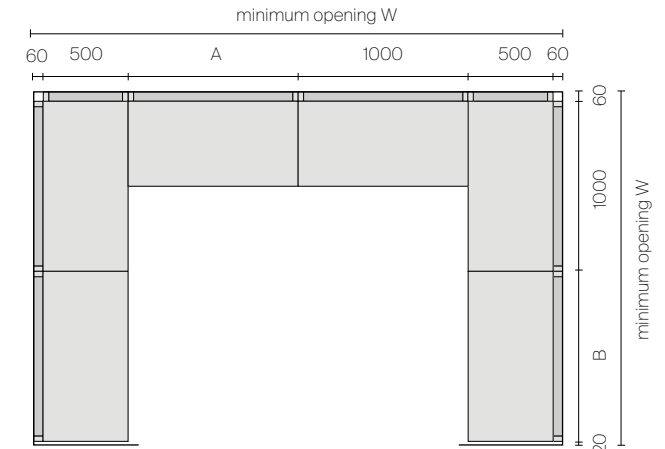



1

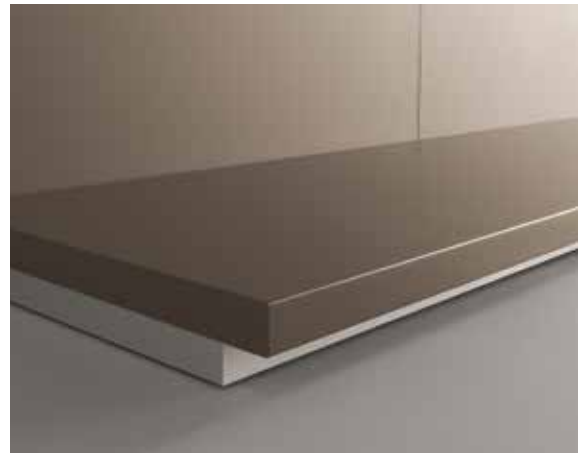

2

1. Suspended drawer unit in tempered lacquered glass. Drawer with totally extractable runners, push opening
2. Floor base in lacquered wood with baseboard in extruded aluminium
3. Pull-out tray with organizer and small tray in synthetic leather. Lacquered glass front
4. Pull-out tray and trousers rack in synthetic leather. Lacquered glass front
5. Detail of glass back panel with upper led lighting system, lacquered shelf with Led spotlight. Clothes-hanger bar in brushed stainless steel covered with synthetic leather
6. Synthetic leather cabinet on wheels
7. Synthetic leather box
8. Synthetic leather tray



3



4



5



6



7



8

Panel in glass, Litech, fabric and synthetic leather finishing. Structure in extruded aluminium. Lacquered aluminium side profile

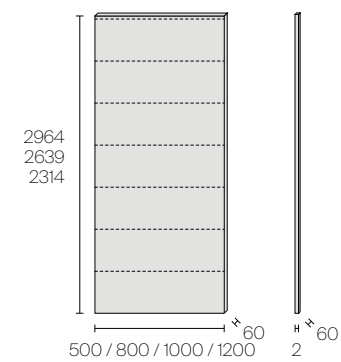

Lacquered shelf in MDF, covered by a double aluminium sheet. Led spotlight for shelves

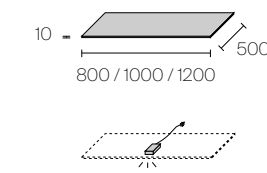

Upper led lighting

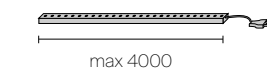

Lacquered shoe rack covered with synthetic leather and led lighting for shoe rack

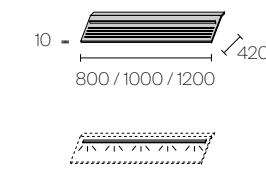

Clothes-hanger bar for shelf, in aluminium or in stainless steel

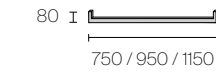

Floor base in lacquered wood with structure in extruded aluminium

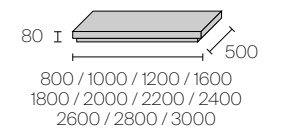

Ceiling clothes-hanger bar in stainless steel

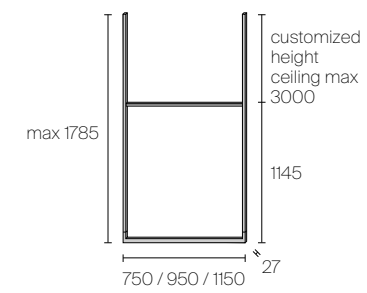

Synthetic leather box, tray, cabinets on wheels and wooden clothes hanger

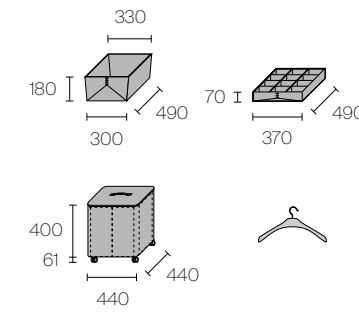

Suspended pullover holder

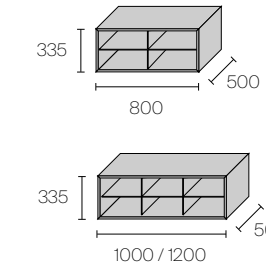

Suspended drawer unit

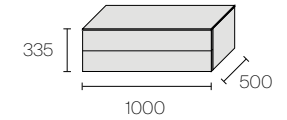

Drawer unit for floor base

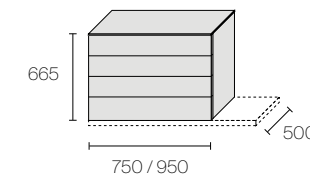

Drawer unit on wheels

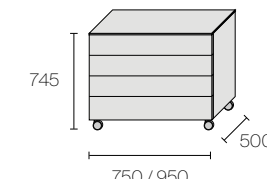

Equipped floor unit with push drawer

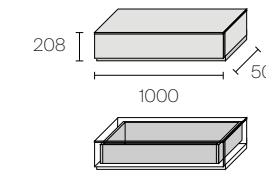

Equipped floor unit for corner with push drawer

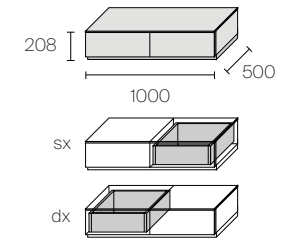

Synthetic leather mat for internal lining

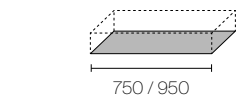

Synthetic leather mat for equipped floor units

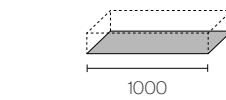

Pull-out tray with organizer and small tray in synthetic leather. Lacquered glass front

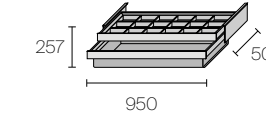

Pull-out tray with organizer and big tray in synthetic leather. Lacquered glass front

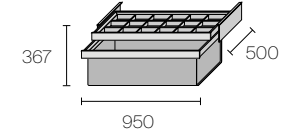

Pull-out tray with organizer and trousers rack in synthetic leather. Lacquered glass front

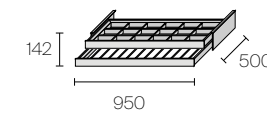

Pull-out tray and small tray in synthetic leather. Lacquered glass front

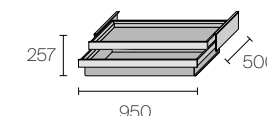

Pull-out tray and big tray in synthetic leather. Lacquered glass front

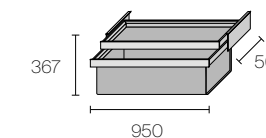

Pull-out tray and trousers rack in synthetic leather. Lacquered glass front

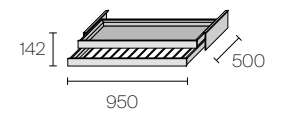

Panels

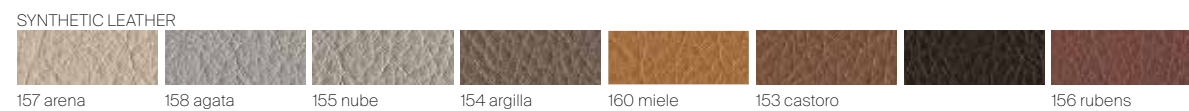
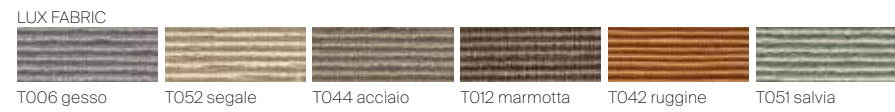
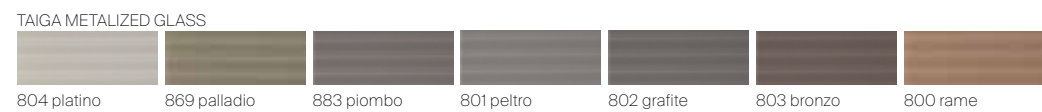
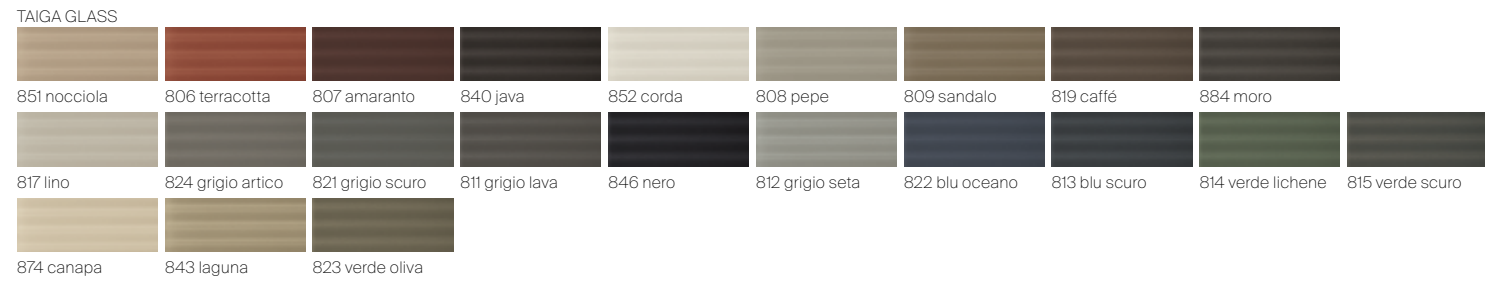
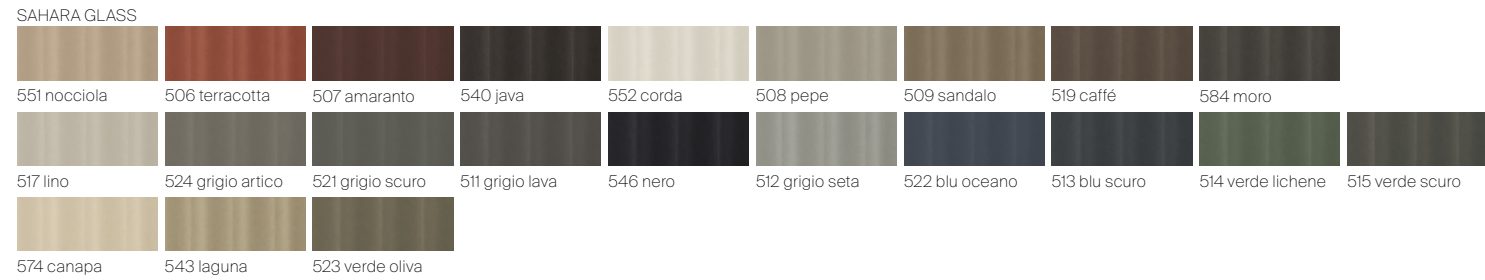

Side aluminium profile, floor base and lacquered shelf

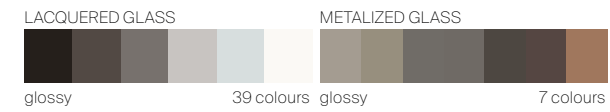

Equipped floor units, suspendend drawer unit and pullover holder

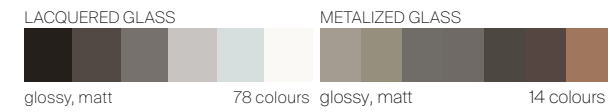

\* only available for pullover holder

Drawer units on wheels and for floor base

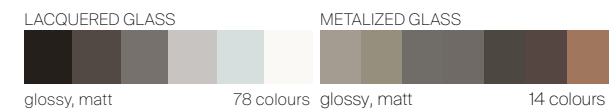

Pull-out glass front

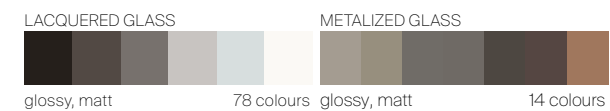

Drawer interior



Structural profiles and baseboard



Pull-out shelves and clothes-hanger bar

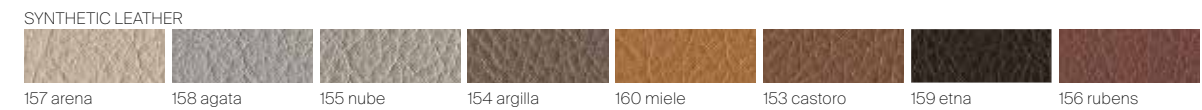
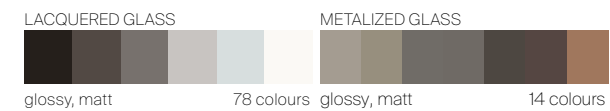

Shoe rack shelf, box, tray, cabinet on wheels, mat for equipped floor units and drawer internal lining

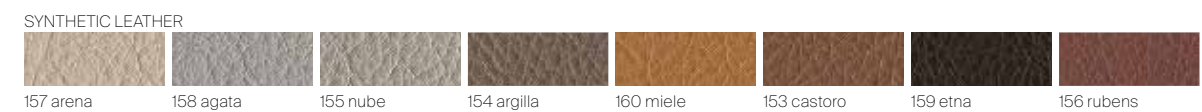

QUALITY AS THE MAIN PURPOSE, ALWAYS AND IN EVERY ASPECT, WITH THIS MISSION RIMADESIO IS CONSTANTLY SEARCHING FOR SOLUTIONS TO IMPROVE ITS OWN ECOLOGICAL STANDARDS.

OBJECTIVE OBTAINED THANKS TO THE USE OF PRECIOUS AND RECYCLABLE MATERIALS, TO THE ABSENCE OF SUBSTANCES THAT CAN BE TOXIC TO HUMANS OR HARMFUL TO THE ENVIRONMENT IN EVERY PHASE OF THE PRODUCTIVE PROCESS, TO THE USE OF TECHNOLOGY AND EVOLVED MACHINERY, POWERED BY CLEAN ENERGY DERIVED FROM PHOTOVOLTAIC SYSTEMS, INSTALLED ON THE GIUSSANO HEADQUARTERS ROOF.

ALUMINIUM, GLASS, WOOD: FULLY RECYCLABLE AND PARTLY ALREADY RECYCLED MATERIALS.

PROOFS OF A REINFORCED GREEN DNA AND WIDE COHERENCE, SIGNALS OF A CONTINUOUS RESEARCH AND A GLANCE TOWARDS THE FUTURE, THAT TAKES SHAPE IN THE TECHNOLOGICAL INNOVATION OF SYSTEMS, DOORS AND FURNITURE, MADE WITH THE AWARENESS OF WANTING TO ENTRUST HUMANS ONLY WITH HIGH VALUE-ADDED ACTIVITIES.

# EXCELLENCE SUSTAINABILITY PROJECT

IT Perseguire la qualità, sempre, sotto tutti gli aspetti. Con questa mission Rimadesio ricerca costantemente soluzioni volte a migliorare i propri standard qualitativi ecologici. Obiettivo ottenuto sinergicamente, grazie all'utilizzo di materiali preziosi e riciclabili, all'assenza di sostanze tossiche per l'uomo e nocive per l'ambiente in ogni fase del processo produttivo, all'impiego di tecnologie e macchinari evoluti alimentati con energia pulita proveniente da impianti fotovoltaici, installati sulla copertura dell'headquarter di Giussano. Alluminio, vetro, legno, materiali totalmente riciclabili e in parte già riciclati, ma anche le vernici prive di solventi di Ecoloursystem e i sistemi di imballaggio ecologici. Testimonianze di un dna green consolidato e di una coerenza trasversale, segnali di una continua attività di ricerca e di uno sguardo sempre proteso al futuro che si declina nell'innovazione tecnologica di sistemi, porte ed arredi, realizzati con la consapevolezza di voler affidare all'uomo solo attività dall'alto valore aggiunto.

DE Stets um Qualität bemüht, und zwar in allen Bereichen. Mit dieser Mission im Blick sucht Rimadesio laufend nach Lösungen, um seine ökologischen Qualitätsstandards zu verbessern. Dieses Ziel wurde dank der Verwendung wertvoller und wiederverwertbarer Materialien, dem Verzicht auf für den Menschen giftige und umweltschädliche Stoffe in jeder Phase des Produktionsprozesses und dem Einsatz fortschrittlicher Technologien und Maschinen, die mit sauberer Energie aus den auf dem Dach des Giussano-Hauptsitzes installierten Photovoltaikanlagen betrieben werden, synergetisch erreicht. Aluminium, Glas, Holz, vollständig recycelbare und teilweise bereits recycelte Materialien, aber auch die Lösungsmittelfreien Farben von Ecoloursystem und umweltfreundliche Verpackungssysteme. Ein Zeugnis einer fundierten grünen DNA und einer transversalen Kohärenz, Zeichen einer kontinuierlichen Forschungstätigkeit und eines stets in die Zukunft gerichteten Blicks, der sich in der technologischen Innovation von Systemen, Türen und Einrichtungsgegenständen ausdrückt, die in dem Bewusstsein realisiert werden, den Menschen nur Tätigkeiten mit hohem Mehrwert anzuvertrauen.

FR Poursuivre la qualité, toujours, et à tous les égards. Avec cette mission Rimadesio recherche constamment de solutions au fin d'améliorer ses normes de qualité écologique. Objectif atteint, grâce à l'utilisation de matériaux précieux et recyclables, l'absence à chaque étape de la production de substances toxiques nocives pour l'homme et l'environnement, l'utilisation de technologies et des machines avancées alimentées par l'énergie solaire après l'installation sur le toit de l'usine à Giussano de systèmes photovoltaïques. Aluminium, verre, bois, des matériaux entièrement recyclables et déjà en partie recyclés, mais aussi peinture Ecoloursystem sans solvants et systèmes d'emballage respectueux de l'environnement. Témoignages d'un adn "vert" consolidé et d'une cohérence transversale, signes de recherche continue et d'une tendance à regarder en avant, qui correspond bien à l'innovation technologique des systèmes, des portes et des meubles, réalisés avec la conscience que l'apport de l'homme dans la production ne peut qu'avoir un valeur ajoutée.

ES Perseguir la calidad, siempre, en todos los aspectos. Con esta misión Rimadesio busca constantemente soluciones destinadas a mejorar sus estándares de calidad ecológica. Objetivo conseguido sinérgicamente, gracias al uso de materiales preciosos y reciclables, a la ausencia de sustancias tóxicas para los seres humanos y nocivas para el medio ambiente en cada etapa del proceso de producción, al uso de tecnologías y máquinas avanzadas alimentadas por energía limpia a partir de sistemas fotovoltaicos, instalados en la cobertura del headquarter de Giussano. Aluminio, cristal, madera, materiales completamente reciclables y, en parte, ya reciclados, sino también las pinturas Ecoloursystem libres de disolventes y los sistemas de embalaje ecológicos. Testimonios de un adn green consolidado y una coherencia transversal, señales de una continua investigación y de una vista siempre tendida al futuro que se declina en la innovación tecnológica de sistemas, puertas y muebles, realizados con el conocimiento que desea confiar al hombre sólo actividades de alto valor añadido.

RU Обеспечение качества всегда и во всем. И, в том числе, для достижения этой цели Компания Rimadesio находится в постоянном поиске решений, направленных на улучшение экологических стандартов качества. Эта цель была достигнута благодаря использованию на каждом этапе производственного процесса ценных материалов, пригодных для вторичной переработки, отсутствию токсичных для человека и вредных для окружающей среды веществ, а также благодаря внедрению передовых технологий и оборудования, работающего на чистой энергии от фотоэлектрических систем, установленных на крыше штаб-квартиры компании в г. Джуссано. Компания использует такие материалы, как алюминий, стекло, дерево – полностью перерабатываемые и уже частично переработанные материалы, краски Ecoloursystem, не содержащие растворителей, а также экологически упаковку. Свидетельство консолидированной экологичности и непрерывной последовательности, исследовательской деятельности и взгляда, всегда устремленного в будущее, что выражается в технологических инновациях систем, дверей и мебели, произведенных с осознанием того, что человеку стоит поручать только деятельность с высокой добавленной стоимостью.

汉语 始终至终追求全方位的卓越品质。Rimadesio 肩负使命，不断探索精进生态质量标准的解决方案。品牌目标之达成有赖于珍贵的可回收材料，该材料在所有制造阶段皆不会产生危害人体和环境之有毒物质，同时结合业界前沿的技术以及先进机械装置；而位于朱塞诺 (Giussano) 品牌总部建筑屋顶上的光伏发电设备为上述之机械装置供给干净的能源。除了可完全回收和已部分回收的铝材、玻璃、木材等材料之外，还有环保色彩系统 (Ecoloursystem) 的无溶剂涂料和生态环保型包装。深植的绿色 DNA、跨领域的协同性、持续的研究工作以及具前瞻性的未来展望皆体现在家具系统、各式门类 and 家具配件的技术创新上，其本着信赖人类才能胜任高附加价值活动的意念研发而成。



## GUIDE TO RIMADESIO QUALITY

### TEMPERED GLASSES

Single tempered glasses cooked at a temperature of 650 °C. Mechanical resistance 5 times superior in comparison to a normal glass. In case of breaking it crumbles in harmless tiny fragments. In accordance with the UNI EN 12150, UNI 7697 and UNI EN 12600 rules with reference to the security of glasses for decoration purposes.

### LAMINATED GLASSES

Double glasses. Between the two glasses a thin plastic film is inserted. Transparent and invisible, it perfectly sticks to both surfaces. Both surfaces are perfectly smooth.Resistance to breaking in accordance with the UNI EN ISO 12543, UNI 7697 and UNI EN 12600 rules. The plastic film witholds the fragments in case of breaking.

### GLASS WITH METAL NET AND MESH

Double laminated glasses. Between the two extra-clear glasses and two thin plastic films a micronet fabric is inserted. Through a sophisticated process a metal layer is applied on the fabric, thus creating a characteristic effect of semi transparency. The reflections of the light on the surface of the metallic net are provided by using an extra-clear float glass, which allows maximum transparency and high light transmissions, thanks to the low content of iron oxides. Following the process of hot stratification, the fabric might show minor wave effect, which give the material its characteristic materic and natural look.

ECOLORSYSTEM LACQUERED GLASSES Ecolorsystem is the name that distinguishes the exclusive Rimadesio lacquered glass collection in glossy and matt finishing. Ecological colours produced using exclusively water paints of latest generation, cooked at 110° C. A production technology in the area of glass, with a fully robotised in-house plant that ensures very high quality results and a low environmental impact work cycle. Corrosion resistance conforms to the UNI EN ISO 9227 standard. Temperature fluctuation resistance conforms to the UNI 9429 standard. The colour is inside the double glass, safe from stains, dust and humidity. The thickness of the glass creates an exclusive "depth" effect.

### VETRI TEMPERATI

Vetri singoli, sottoposti al trattamento della tempra ovvero ad una cottura alla temperatura di 650 °C. Resistenza meccanica di 5 volte superiore rispetto ad un vetro normale. In caso di rottura si sbriciola in minuti frammenti inoffensivi. Conformi alle norme UNI EN 12150, UNI 7697 e UNI EN 12600 in materia di sicurezza per i vetri d'arredamento.

### VETRI STRATIFICATI

Vetri doppi. Fra i due vetri è inserita una sottile pellicola di materiale plastico, trasparente ed invisibile, che aderisce completamente alle due superfici. Entrambe le superfici sono perfettamente lisce. Resistenza alla rottura conforme alle norme UNI EN ISO 12543, UNI 7697 e UNI EN 12600. La pellicola di materiale plastico in caso di rottura trattiene i frammenti.

### VETRI STRATIFICATI RETE, MAGLIA E FIBRA

Vetri doppi stratificati. Tra i due vetri extrachiari e le due sottili pellicole in materiale plastico, è inserito un tessuto in microrete sul quale, tramite un sofisticato processo di materizzazione, viene depositato uno strato metallico che crea un caratteristico effetto di semitrasparenza. Le riflessioni della luce sulla superficie della rete metallizzata sono ottenute con l'utilizzo del vetro float extrachiaro che, grazie al basso contenuto di ossidi di ferro, garantisce la massima trasparenza e un'elevata trasmissione luminosa. Il tessuto, a seguito del processo di stratifica a caldo, può presentare delle leggere ondulazioni che conferiscono al materiale il suo caratteristico aspetto materico e naturale.

VETRI LACCATI ECOLORSYSTEM Ecolorsystem è la denominazione che contraddistingue l'esclusiva collezione di vetri laccati Rimadesio, disponibili in finitura lucida e opaca. Colori ecologici perché prodotti utilizzando esclusivamente vernici all'acqua di ultima generazione, con cottura a 110°C. Una tecnologia produttiva all'avanguardia nell'ambito del vetro, con impianti interni totalmente robotizzati che assicurano risultati di altissima qualità e un ciclo di lavorazione a basso impatto ambientale. Resistenza alla corrosione conforme alla norma UNI EN ISO 9227. Resistenza agli sbalzi di temperatura conforme alla norma UNI 9429. Colori inalterabili nel tempo perché applicati sulla superficie interna del vetro, al sicuro da macchie, polvere e umidità. Lo spessore del vetro crea un esclusivo effetto di "profondità".

### TEMPERIERTES GLAS

Einzelgläser, die einer Härtingsbehandlung oder einer Kochtemperatur von 650 °C unterzogen wurden. Mechanische Beständigkeit 5 mal höher als bei normalem Glas. Im Bruchfall zerbröckeln harmlose Bruchstücke in Minuten. Entspricht den Normen UNI EN 12150, UNI 7697 und UNI EN 12600 für die Sicherheit von Möbelgläser.

### SCHICHTGLAS

Doppelgläser. Zwischen den beiden Gläsern befindet sich ein dünner Film aus transparentem und unsichtbarem Kunststoff, der vollständig an den beiden Oberflächen haftet. Beide Oberflächen sind komplett glatt. Die Bruchfestigkeit entspricht den Normen UNI EN ISO 12543, UNI 7697 und UNI EN 12600. Die Kunststofffolie bewahrt im Bruchfall die Bruchstücke.

### SCHICHTGLAS MIT METALLNETZ, GLASGITTER UND FASER

Hierbei handelt es sich um Doppel-schichtgläser. Zwischen den zwei Extralight-Glasscheiben und den beiden unsichtbaren Plastikfolien wird ein Metallnetz deposited auf ce tissu, créant un effet caractéristique translucide. Les reflets de la lumière sur la surface de la maille métallique sont obtenus avec l'utilisation du verre float extra clair, qui, grâce à un faible teneur de oxydes de fer, permet un maximum de transparence et de transmission de la lumière. Suite au procédé de stratification à chaud, le tissu peut présenter de petites ondulations, qui apportent au matériau son aspect caractéristique et naturel.

LACKIERTE GLÄSER ECOLORSYSTEM Ecolosystem ist der Name der lackierten Glas-Kollektion von Rimadesio in der glänzend und matte Ausführung verfügbar. Absolut oekologische Farben, da die modernsten Lackierungen, auf Wasser-Basis, an einer Temperatur von 110° gekocht werden. Eine fortschrittliche Produktionstechnik in der Glasverarbeitung auf einer vollautomatisierten Anlage, die Ergebnisse höchster Qualität und gleichzeitig umweltfreundliche Verarbeitungsverfahren gewährleistet. Korrosion-sprüfung gemäß Bestimmung UNI EN ISO 9227. Temperaturwechselprüfung gemäß Bestimmung UNI 9429. Unverändliche Farben da die Farbung sich im Innen des Doppelglases, geschützt vor Staub, Kratzen und Feuchtigkeit, befindet. Die Dicke des Glases erzeugt eine einzigartige Tiefwirkung.

### VERRES TREMPÉS

Verres simples, soumis au traitement de trempe et donc à une température de cuisson de 650 °C. Résistance mécanique 5 fois supérieure à celle du verre normal. En cas de rupture, des fragments inoffensifs s'effritent en quelques minutes. Conforme aux normes UNI EN 12150, UNI 7697 et UNI EN 12600 pour la sécurité des verres pour les meubles.

### VERRES STRATIFIÉS

Double verres. Entre les deux verres se trouve une fine pellicule de matière plastique, transparente et invisible, qui adhère complètement aux deux surfaces. Les deux surfaces sont parfaitement lisses. La résistance aux ruptures est conforme aux normes UNI EN ISO 12543, UNI 7697 et UNI EN 12600. La pellicule retient les fragments en cas de rupture.

### VERRE FEUILLETÉ AVEC NET, MAILLE ET FIBRA

Double verre stratifié. Entre les deux verres extra clair et les deux films fins de matière plastique un tissu en micro maille est ajouté. A travers un procédé avancé de materisation un couche métallique est déposé sur ce tissu, créant un effet caractéristique translucide. Les reflets de la lumière sur la surface de la maille métallique sont obtenus avec l'utilisation du verre float extra clair, qui, grâce à un faible teneur de oxydes de fer, permet un maximum de transparence et de transmission de la lumière. Suite au procédé de stratification à chaud, le tissu peut présenter de petites ondulations, qui apportent au matériau son aspect caractéristique et naturel.

### VERRES LAQUÉS ECOLORSYSTEM

Ecolorsystem est le nom qui caractérise la collection exclusive de verres laqués de Rimadesio disponibles en finition brillante et mate. Couleurs écologiques, parce que produits en utilisant exclusivement vernis à l'eau de dernière génération, cuites à 110°. Une technologie de production avant-gardiste dans le domaine du verre, avec des équipements internes entièrement robotisés qui assurent des résultats de grande qualité et un cycle de production ayant un impact très faible sur l'environnement. Résistance à la corrosion conformément à la norme UNI EN ISO 9227. Résistance aux écarts de température conformément à la norme UNI 9429. Couleurs inaltérables parce qu'ils sont appliqués dans la surface interne du verre, pour protéger de la poussière humidité et taches. L'épaisseur du verre crée un exclusif effet profondeur.

### CRISTALES TEMPLADOS

Vidrios simples, sometidos al tratamiento de templado a una temperatura de cocción de 650 °C. Resistencia mecánica de 5 veces mayor que el vidrio normal. En caso de rotura, se desmoronan fragmentos inofensivos. Conforme a las normas UNI EN 12150, UNI 7697 y UNI EN 12600 en materia de seguridad para los cristales en el amueblamiento.

### CRISTALES ESTRATIFICADO

Vidrios dobles. Entre los dos vidrios hay una película fina de material plástico, transparente e invisible, que se adhiere completamente a las dos superficies. Ambas superficies son perfectamente lisas. La resistencia a la rotura cumple con las normas UNI EN ISO 12543, UNI 7697 y UNI EN 12600. La película de plástico en caso de rotura retiene los fragmentos.

### CRISTALES ESTRATIFICADOS RED METÁLICA, MAILLA Y FIBRA

Cristales dobles estratificados. Entre los dos cristales extraclaros y las dos capas sintéticas, está inserido en un tejido de microred en el que, a través de un sofisticado proceso se deposita una característica de efecto semitransparente. Los reflejos de la luz sobre la superficie de la red metálica se proporcionan con el uso del vidrio float extraclaro que, gracias a su bajo contenido en óxidos de hierro, asegura la máxima transparencia y una alta transmisión de luz. El tejido, siguiendo el proceso de estratificación en caliente, puede presentar ligeras ondulaciones que dan al material su aspecto característico natural.

CRISTALES LACADOS ECOLORSYSTEM Ecolorsystem es la denominación que marca la exclusiva colección de los cristales lacados Rimadesio, disponibles en acabado brillante y mate. Colores ecológicos porque productos utilizando exclusivamente pinturas al agua de última generación, con cocción a 110°. Una tecnología productiva a la vanguardia en el ámbito del cristal, con unas instalaciones internas totalmente robotizadas que aseguran resultados de altísima calidad y un ciclo de tratamiento respetuoso del medio ambiente. Resistencia a la corrosión conforme a la norma UNI EN ISO 9227. Resistencia a las variaciones de temperatura conforme a la norma UNI 9429. Colores inalterables en el tiempo porque aplicados en la superficie interior del cristal, al resguardo de manchas, polvo y humedad. El grosor del cristal crea un exclusivo efecto de "profundidad".

### ЗАКАЛЕННОЕ СТЕКЛО

Механическая прочность одинарных стекол, подвергнутых закалке, т.е. обжигу при температуре 650°С, в 5 раз выше, чем у обычного стекла. Если такое стекло разбить, оно рассыпется на мелкие неопасные осколки. Соответствует стандартам безопасности UNI EN 12150, UNI 7697 и UNI EN 12600 для мебельного стекла.

### МНОГОСЛОЙНОЕ СТЕКЛО

Двойные стекла. Тонкая, прозрачная и невидимая пластиковая пленка прокладывается между двумя стеклами и полностью приклеивается к обеим поверхностям. Обе поверхности идеально гладкие. Проверка прочности на разрыв была выполнена в соответствии со стандартами UNI EN ISO 12543, UNI 7697 и UNI EN 12600. Эта пленка способна удерживать осколки разбившегося стекла.

МНОГОСЛОЙНОЕ СТЕКЛО, СТЕКЛО С СЕТКОЙ Многослойное двойное стекло. Между двумя сверхпрозрачными стеклами и двумя тонкими пластиковыми пленками вставляется микросетчатое полотно, на которое в ходе сложного производственного процесса наносится металлический слой, благодаря чему и формируется характерный полупрозрачный эффект. Отражение света на поверхности металлизированной сетки достигается за счет использования сверхчистого флот-стекла, которое из-за низкого содержания оксида железа гарантирует максимальную прозрачность и высокую светопропускную способность.

В результате процесса наслаивания в горячем виде полотно приобретает небольшие волнистости, которые придают материалу характерную текстуру и натуральный вид.

### ЛАКИРОВАННОЕ СТЕКЛО

ECOLORSYSTEM Ecolorsystem — это название эксклюзивной коллекции лакированного стекла Rimadesio, доступной в глянцевой и матовой отделке. Коллекция характеризуется мягкими спокойными цветами, поскольку при их производстве используются только краски последнего поколения на водной основе, запекаемые при температуре 110°С. В стекольной промышленности в настоящее время внедряются современные производственные технологии, полностью роботизированные заводы, обеспечивающие высокое качество и незначительное воздействие на окружающую среду. Коррозионная стойкость соответствует требованиям положений стандарта EN ISO 9227. Устойчивость к изменениям температуры соответствует требованиям стандарта UNI 9429. Цвет характеризуется исключительной долговечностью, поскольку краски наносятся на внутреннюю поверхность стекла, защищенную от пятен, пыли и влаги. Толщина стекла создает уникальный эффект «глубины».

钢化玻璃 单片玻璃通过淬火工艺,即经 650 °C 高温烧制而成,其机械阻力相较于普通玻璃高出 5 倍。钢化玻璃破裂时会碎成不易伤人的细小碎片。符合家具玻璃安全材质 UNI EN 12150、UNI 7697 以及 UNI EN 12600 的标准。

### 夹层玻璃

双层玻璃。在两片玻璃之间夹有一层纤薄、透明、无形的塑料薄膜,其完全贴合两片玻璃的表面。两片玻璃的表面皆光滑无比。其抗裂性能符合 UNI EN ISO 12543、UNI 7697 以及 UNI EN 12600 的标准。玻璃破裂时,其碎片会粘在塑料薄膜上,裂而不散。

网夹层玻璃、网格夹层玻璃和纤维夹层玻璃 双层夹层玻璃。在两片超清玻璃和两层纤薄的塑料薄膜之间夹入一层微型网状物质,一道细腻的材质加工工艺,会在织物上覆盖一层金属并创造出半透明的特殊效果。使用超清浮法玻璃产出金属网表面的光线反射,因玻璃的氧化铁含量低,可确保最大透明度和高透光率。通过热分层加工工艺,夹入的织物会有不平整的现象,从而呈现出具有特色的材质纹理和自然感的外观。

环保色彩系统 (Ecolorsystem) 的烤漆玻璃 Ecolorsystem 为 Rimadesio 烤漆玻璃独家系列的名称,有亮面和哑光两种表面处理可供选择。由于仅使用最新一代的水性涂料搭配 110°C 烘烤工序完成而被称为生态环保性色彩;其为超前玻璃业界的生产技术,而全机器人化的内部设备确保极高的产品质量和低环境冲击的加工循环。其抗腐蚀程度符合 UNI EN ISO 9227 的标准。其抗温度急变性符合 UNI 9429 的标准。因色彩涂层夹于玻璃内层,因此不会褪色且不受脏污、灰尘和湿气的影响。玻璃的厚度创造出一种独特的“深度”效果。

ECOLORSYSTEM LACQUERED GLASS

GLOSSY MATT		GLOSSY MATT		GLOSSY MATT		GLOSSY MATT		GLOSSY MATT		GLOSSY MATT			
305	138 cipria	45	97 avorio	59	105 grigio chiaro	40	115 grigio cenere	53	95 bianco neve	50	108 bianco latte		
51	113 nocciola	52	107 corda	56	98 lino	312	145 grigio seta	47	96 grigio perla	78	114 sabbia		
306	139 terracotta	85	130 tufo	310	143 creta	38	121 azzurro cera	36	117 blu Londra	74	110 canapa		
76	116 rosso india	308	141 pepe	317	600 grigio artico	35	100 blu notte	39	122 verde inglese	73	109 giallo kashmir		
75	129 amaranto	309	142 sandalo	88	132 grigio scuro	86	131 blu oceano	314	147 verde lichene	43	119 laguna		
307	140 java	58	99 caffè	311	144 grigio lava	313	146 blu scuro	315	148 verde scuro	33	111 verde oliva		
		84	128 moro	46	102 nero					316	149 verde terra		

ECOLORSYSTEM METALIZED GLASS

GLOSSY MATT		SAHARA		TAIGA		DIAMANTE	
304	137 platino	504	platino sahara	804	platino taiga	404	platino diamante
69	126 palladio	569	palladio sahara	869	palladio taiga	469	palladio diamante
83	127 piombo	583	piombo sahara	883	piombo taiga	483	piombo diamante
301	134 peltro	501	peltro sahara	801	peltro taiga	401	peltro diamante
302	135 grafite	502	grafite sahara	802	grafite taiga	402	grafite diamante
303	136 bronzo	503	bronzo sahara	803	bronzo taiga	403	bronzo diamante
300	133 rame	500	rame sahara	800	rame taiga	400	rame diamante

ECOLORSYSTEM SAHARA GLASS

551	nocciola sahara	552	corda sahara	517	lino sahara	512	grigio seta sahara	514	verde lichene sahara	574	canapa sahara
506	terracotta sahara	508	pepe sahara	524	grigio artico sahara	522	blu oceano sahara	515	verde scuro sahara	543	laguna sahara
507	amaranto sahara	509	sandalo sahara	521	grigio scuro sahara	513	blu scuro sahara			523	verde oliva sahara
540	java sahara	519	caffè sahara	511	grigio lava sahara						
		584	moro sahara	546	nero sahara						

ECOLORSYSTEM TAIGA GLASS

851	nocciola taiga	852	corda taiga	817	lino taiga	812	grigio seta taiga	814	verde lichene taiga	874	canapa taiga
806	terracotta taiga	808	pepe taiga	824	grigio artico taiga	822	blu oceano taiga	815	verde scuro taiga	843	laguna taiga
807	amaranto taiga	809	sandalo taiga	821	grigio scuro taiga	813	blu scuro taiga			823	verde oliva taiga
840	java taiga	819	caffè taiga	811	grigio lava taiga						
		884	moro taiga	846	nero taiga						

NEUTRAL GLASS

55	specchio
68	specchio grigio

TRANSPARENT GLASS

890	trasparente taiga
590	trasparente sahara
490	trasparente diamante
05	trasparente extrachiaro
00	trasparente
63	grigio trasparente
65	bronzo trasparente
390	verde trasparente
391	blu trasparente

SATINATED GLASS

67	riflettente chiaro
64	riflettente grigio
81	riflettente bronzo
891	acidato taiga
591	acidato sahara
02	acidato extrachiaro
01	acidato
03	acidato grigio
04	acidato bronzo
82	nuvola extrachiaro
80	nuvola

MESH GLASS

60	rete alluminio
61	rete inox
62	rete bronzo
66	maglia gold
87	maglia rame
06	fibra argento
08	fibra bronzo

REFLEX GLASS

90	bianco reflex
92	kaki reflex
94	cacao reflex
89	nero reflex







ECOLORSYSTEM MATT LACQUERED

 305 cipria	 45 avorio	 59 grigio chiaro	 40 grigio cenere	 53 bianco neve	 16 bianco latte
 51 nocciola	 52 corda	 56 lino	 312 grigio seta	 47 grigio perla	 78 sabbia
 306 terracotta	 85 tufo	 310 creta	 38 azzurro cera	 36 blu Londra	 74 canapa
 76 rosso india	 308 pepe	 317 grigio artico	 35 blu notte	 39 verde inglese	 73 giallo kashmir
 75 amaranto	 309 sandalo	 88 grigio scuro	 86 blu oceano	 314 verde lichene	 43 laguna
 307 java	 58 caffè	 311 grigio lava	 313 blu scuro	 315 verde scuro	 33 verde oliva
	 84 moro	 13 nero			 316 verde terra

ECOLORSYSTEM LACQUERED METALIZED

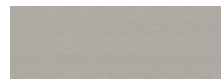
 304 platino	 302 grafite
 69 palladio	 303 bronzo
 83 piombo	 300 rame
 301 petro	

ALUMINIUM

 31 alluminio lucido
 30 alluminio
 14 brown
 318 nickel grigio
 22 nero lucido

LEATHER

 C23 bianco ghiaccio
 C17 sand
 C29 toupè
 C22 caramello
 C28 fango
 C11 moka

SYNTHETIC LEATHER

 157 arena
 158 agata
 155 nube
 154 argilla
 160 miele
 153 castoro
 159 etna
 156 rubens









LUX FABRIC

 T006 gesso
 T052 segale
 T044 acciaio
 T012 marmotta
 T042 ruggine
 T051 salvia

MATERIAL FABRIC

 T020 nebbia
 T019 papiro
 T009 piuma
 T017 roccia
 T001 terracotta
 T003 brandy
 T018 tabacco

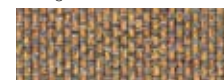
TECH FABRIC

 TT01 duna
 TT03 tortora
 TT05 mosto
 TT07 antracite
 TT09 fumo
 TT10 ghiaccio
 TT11 giada
 TT19 canyon
 TT20 dolomiti
 TT21 cedro

LITECH

 G001 crema
 G002 moka
 G003 pietra
 G004 grigio rigato

MARBLE

 28 calacatta
 184 crystal grey
 186 crystal brown
 180 emperador
 183 noir saint laurent
 187 verde lepanto
 182 rosso lepanto
 181 nero marquinia

MATT MARBLE

 198 calacatta opaco
 194 crystal grey opaco
 191 nero marquinia opaco
 185 crystal white opaco

WOOD

 711 rovere
 15 noce
 19 rovere termotrattato
 27 rovere nero
 710 tinto ebano

SAHARA WOOD

 17 noce sahara
 20 rovere termotrattato sahara



TAIGA WOOD

 701 rovere taiga
 700 tinto ebano taiga

MELAMINE

 07 melaminico olmo
 09 melaminico rovere grigio
 25 melaminico larice carbone

INTERNAL MELAMINE

 UB07 mel. cuoio grigio
 UB09 mel. cuoio brown

Collection designed by Giuseppe Bavuso.

# GRÜN BECK

RIMADESIO - WIEN . AT

interior architects | design brand stores

Margaretenstraße 93 | A-1050 Wien  
<https://rimadesio-wien.at>  
+43 1 306 35 41  
[rimadesio@gruenbeck.co.at](mailto:rimadesio@gruenbeck.co.at)

RIMADESIO SPA  
Via Furlanelli 96  
20833 Giussano (MB) Italy  
T +39 0362 3171  
[rimadesio@rimadesio.it](mailto:rimadesio@rimadesio.it)

MILANO FLAGSHIP STORE  
Via Visconti di Modrone 26  
20122 Milano Italy  
T +39 02 76280708  
[milano@rimadesio.it](mailto:milano@rimadesio.it)

LONDON FLAGSHIP STORE  
83-85, Wigmore street  
1WU 1DL London  
T +44 2074 862193  
[london@rimadesio.co.uk](mailto:london@rimadesio.co.uk)

NEW YORK FLAGSHIP STORE  
102 Madison Ave  
New York, NY 10016  
T +1 917 388 2650  
[usa@rimadesio.us](mailto:usa@rimadesio.us)

[www.rimadesio.it](http://www.rimadesio.it)

Art direction and graphic project: Juma  
Photo: Federico Cedrone, Santi Caleca  
Technical photo: F2 Fotografia  
Styling: Studiopepe; Patrizia Cantarella with Rossella Ballabio;  
Martina Lucatelli with Martina Dalla Bona;  
Simona Silenzi Studio; Gaia Marchesini and Giordano Sarno.

Thanks to: Amini Carpets, Ames, Arper, Astep, Baxter, B&B Italia, Carl Hansen & Søn, Egidio Milesi, Emil, Flexform, Flos, Fontana Arte, FPM Milano, Fritz Hansen, IWATA, Henry Timi, Ittala Karakter, Lanerossi, Living divani, Minotti, Nude Glass, Noorth, Oluce, Pallucco, Rains, Rubelli, Salvatori, Scandola Marmi, Up to you Anthology, Vluu / Intentions, Vitra, When Objects Work.

Films and print: Optima  
Printed in Italy, 2024

#### AWARDS

1993	Siparium	Young & Design
2000	Zenit	Award KBB
2001	Zenit	selection Design Index ADI
2002	Siparium	Top100 Frames
2005	Graphis	selection Design Index ADI
2007	Vela	selection Design Index ADI
2008	Vela	mention XXI Premio Compasso d'Oro ADI
2015	Wind	winner Red Dot Award
2016	Cover	Best Furniture System AZ Award
2016	Alambra	selection Design Index ADI
2017	Sail	selection Design Index ADI
2017	Soho	Architectural products AZ awards
2017	Daimon	Interior Design Magazine Best of Year awards
2020	Modulor	People's Choice winner AZ Awards
2020	Modulor	Architectural Products Award of Merit AZ Awards
2020	Modulor	selection Design Index ADI
2021	Francis	selection Design Index ADI
2021	Modulor	LivingEtc Style Awards
2022	Maxi	selection Design Index ADI
2022	Aliante	finalist Interior's best of the Year awards
2022	Aliante	finalist A+Product awards
2023	Maxi	winner German Design Awards
2023	Radius	Architect's Newspaper's Best of Products Awards

#### PATENTED:

Radius, Aliante, Rialto, Maxi, Sail, Soho, Velaria, Stripe, Daimon, Graphis, Zen, Zen frame, Siparium, Moon, Vela, Luxor, Even, Aura, Spin, Link+, Planet, Flat, Alambra, Abacus living, Self, Cover, Zenit, Dress bold, Abacus.

#### REGISTERED TRADEMARKS:

Rimadesio, Colorsystem, Litech, Siparium, Velaria, Abacus.



Follow us on Instagram, Facebook, LinkedIn,  
WeChat, Weibo, Little Red Book.

